



KARL SCHAPPELLER

THE PHYSICS
OF THE
PRIMARY STATE
OF MATTER

And Application Through the
Primary Technique

BY

CYRIL W. DAVSON

M.I.MECH.E., M.INST.PET.

1955

ELVERTON BOOKS
PUBLISHERS AND DISTRIBUTORS
SOUTHAMPTON HOUSE
317 HIGH HOLBORN
LONDON W.C.1

“Anyone who sees in his own occupation merely a means of earning money degrades it; but he that sees in it a service to mankind ennobles both his labour and himself.”

DEDICATION

The history of Science is a record of human—of very human—striving and endeavour. The scientist, like the soldier, knows that no partial effort will gain him his objective. There is no “easy chair” for the pioneers in Science; they must attune themselves to the etheric vibrations, and for this no sacrifice must be considered too great, no suffering—mental or physical—too intolerable. They must endure for a time, for a long time, perhaps even for a lifetime, and perchance with little or apparently nothing to show for their labours.

Long is the list of such intrepid scientific pioneers. To the best of my knowledge there is, nevertheless, only one, call him what you will—scientist, scientific worker, or a mere Student of Nature—who has ever worked towards “origin” on scientific lines, fully knowing that true origin is, and must be, “Consciousness,” and that the sun, the stars and the galaxy of the heavens are, and can only be, an outward manifestation of a universal conscious whole—as it were, the outward and conscious-physical sign of an inward and spiritual Origin.

The book is my interpretation of this man’s work and I dedicate it to him, as he dedicated himself to his labours—and endured.

To Karl Schappeller of Castle Aurolzmünster, in the district of Inviertel in the Province of Upper Austria, who died in July 1947.

FOREWORD

This book was written in 1942 but not at that time with a view to publication.

It was written as a permanent record of Karl Schappeller's work for future reference. But typescript is by no means permanent. The only permanency is to have printed copies available in the principal libraries of this country.

There is, however, another and important aspect here. Schappeller has not merely evolved the Primary Physics and thereby discovered, as he claims, the Primary Force in all Nature, and thus the origin of the gravitational force—his claim goes further than this. He is confident that, given the financial help and the necessary facilities, he can actually produce and demonstrate the application of the Primary Force, in the first instance, to the generation of mechanical power and later, as will be seen from the Treatise, to many other important purposes, including the medical.

In view of the above, I consider it desirable, if not obligatory, that the nature of Schappeller's discoveries should now be made known, and I hope and believe that the publication of this book in some measure satisfies this requirement. But it should be clearly understood that the Treatise deals only with principles and the suggested application of these principles, and that it is definitely not intended to provide the technical data for the production, demonstration and practical application of the Primary Force. That I regard as Karl Schappeller's own prerogative.

Owing to the War, I have been separated entirely from Karl Schappeller for a period of six years. Schappeller has not therefore even seen the book, nor, of course, has it been either allowable or feasible to communicate with him in any way, and as he has no knowledge of the English language he could not in any case have studied it until a German translation or German edition was available. An expert translation will take a considerable period to produce even after all the arrangements are made to carry this work through.

Due, therefore, to the fact that this Treatise was written during the greatest world upheaval in the history of man, I had to write it entirely alone and without assistance of any kind. Furthermore, the subject is the original work of Schappeller, and to the best of my knowledge all the literature which up to the present existed on this discovery consisted of a few small pamphlets.

I feel it would be tempting fate too far even to express a pious hope that there are no glaring errors, let alone minor discrepancies, inconsistencies or vexations of a like character to irritate or affront the serious student, and I feel that it would not be premature to make in advance my apology for any such possible lapses or shortcomings.

But by errors or discrepancies I do not mean statements or findings which are or may be at variance with present scientific thought, which itself is always by its very nature in a transition stage or state of flux. I mean, of course, errors or discrepancies which are palpably wrong either in the Primary or Secondary (or present) Physics.

A very important point arises here. I urge the serious reader always to discriminate with great care between statements which refer to the Primary and those which can only refer to the Secondary States of Matter. Nature does not and cannot function in the Secondary States as she does in the Primary State, although it is often possible to trace the origin of known phenomena in the Secondary States to the functioning in the Primary State, and thus to correlate the Primary and Secondary Physics so far as the former is discernible in the latter.

So complex is this subject that to review the book briefly here would be inadequate and lead me into partialities and ill-considered half-truths, whereas to review it at length would be to re-write it. But I have added an Appendix connected by references to certain paragraphs in the text where I have decided that more information or further comment is necessary. I have followed this by a final section to the Appendix entitled "Miscellaneous," in which, as it were, I gather up loose ends and fragments.

I should hardly have completed my task had I omitted

FOREWORD

to express my appreciation of those who, in their various ways, have made the writing and publication of this book possible—John Ogilvy of Inshewan; Harry Gibb and his wife Margaret, Glenisla House, Perthshire; Dr C. F. Hacker, M.C.; the Hon. Mrs Selina Kay-Shuttleworth; Michael Scott, B.D., M.A.; Sir David Russell, LL.D.; and Miss Eileen Le Brand for typing the book and the meticulous task of correcting and revising the proofs with me.

THE AUTHOR.

CONTENTS

PART I

THE PHYSICS OF THE PRIMARY STATE OF MATTER

CHAPTER		PAGE
I.	Introduction	17
II.	The Nomenclature with New Definitions	28
III.	Creation	38
IV.	The Cosmos	40
V.	The Vacuum	50
VI.	Latent Magnetism	60
VII.	Space and its Functioning	68
VIII.	Origin-Matter and its Functioning	77
IX.	Heat and Cold	82
X.	Electrons, Ions and Sublimates	85
XI.	States of Matter	87
XII.	The Origin-Matter	91
XIII.	The Four Conditional Elements	94
XIV.	Fire (Positive) or Flame	97
XV.	Water	103
XVI.	Water (in Relation to the Sun). Formation of Sun's Periphery	110
XVII.	Primary Water Cycle	113
XVIII.	Steam (Generation)	115
XIX.	Air	119
XX.	Earth (the Building of an Earth's Crust)	122
XXI.	The Earth's Motion	130
XXII.	Entropy	134
XXIII.	The Electric Current	142
XXIV.	Lightning	169
XXV.	Supra-conductivity	179
XXVI.	Gravitation	185

PART II

THE NEW TECHNIQUE	209
-----------------------------	-----

PART III

THE MEDICAL SECTION WITH A SUPPLEMENT	255
---	-----

APPENDIX

PART I

THE PHYSICS OF THE PRIMARY STATE
OF MATTER

CHAPTER I

INTRODUCTION

This book is not a translation. To the best of the author's knowledge no book exists in any language on the Primary Physics. The author had therefore to develop and correlate the principles and the application of these principles to the best of his ability, but he does not claim infallibility.

Nevertheless, the author knows more than he has disclosed in this book, and Schappeller, the master mind who evolved and established the whole Primary Physics and its technical applications, knows considerably more than he disclosed to the author.

The book was not written primarily for publication, or indeed publicity of any kind, for "too many counsellors bring confusion."

A glance at the Contents will indicate at once that this book covers an all-embracing field of thought, and although the first application would appear to be an engineering one, the book cannot be read as a whole and be basically understood merely by what may be described as "the engineering mind." Likewise, the medical profession and biologists may not understand the Engineering Section.

Again, the astrophysicist and physicist alone cannot hope to grasp the full significance of what has been written here as present Physics is entirely material.

Astrophysicists, physicists, chemists and engineers deal only with devitalised forces and devitalised matter, such forces having "characteristic" but no consciousness.

On the other hand, biologists apply their theoretical and practical knowledge directly to the functioning of living organisms and organic life in animalia and plants. The doctors, even more than others, are concerned and confronted with this, the most basic of all phenomena, the "life force," which owes its origin, not to some haphazardry or coincidence, but to the conscious-physical, the biomagnetic, the Primary Force, the origin of which is and must be consciousness, the All-Pervading Universal Consciousness which could not therefore have been created but must be the Creator, and of which all things are conscious-physical derivatives either in dynamic, static or latent conscious conditions, and in the energy, gaseous, liquid or solid physical states.

One critic of this book, a doctor, declared that "what has not been written in these pages is, by inference, perhaps as important as that contained in the written word."

This is what the author means by grasping the significance of this Treatise, which deals first with "origin," that is, origin force, origin matter, and later the derivatives out of this, the secondary forces and the secondary states of matter, all of which are conscious-physical; active, where they can function freely; possessing "characteristic" where they are devitalised forces (*e.g.* electric current, etc.); latent (as cohesive force) where it builds and binds material, but always and in every case with the conscious-physical within it. And, borrowing a simple but expressive phrase from the great American President, Theodore Roosevelt, "there is no use in blinking at the fact" that the Primary Force is a conscious or biophysical force, the full significance of which can only become apparent by the "ultra-applications" made possible through the new Primary Techniques.

Another important point is the question of proof. Nothing in Science is proven basically. The origin of worlds is utterly nebulous. The Copernican system is merely a concept and is restricted to relative motions without Origin or Cause, yet it forms the basis of modern astronomy. Science at present has no knowledge nor conception of "actual origin" because actual origin is conscious-physical and the Primary Physics is the physics of the conscious-physical

INTRODUCTION

force without which obviously neither the conscious nor physical condition could exist, and thus nothing could exist.

Whereas who would be so incautious as to state and on what grounds could a statement be based that Schappeller could not fulfil his claim actually to produce and demonstrate the application of the Primary Force to all branches of human activity, but firstly to the production of mechanical power? It has not yet been produced and demonstrated for reasons explained later in this Chapter.

Those interested are therefore invited to study what has been written in these pages, its significance and the evidence afforded through the explanation of the origin of cosmic phenomena and phenomena occurring in the secondary states, *i.e.* throughout the techniques, rather than to confuse the issue by demanding proof line by line as if the whole subject were merely a new technical application of the present Physics, instead of *an entirely new and basic Physics supported by an elaborate technique (Part II), in which it is shown how, according to this technique, the Primary Force could be produced and applied.*

The subject has so many aspects that it requires to be handled with finesse and discrimination, integrity yet vision, courage and helpful criticism, determination in place of fear. It is cognate but has multifarious applications, and requires systematic and judicious manipulation to avoid confusion.

Difficulties exist, but they will not be solved either by optimism or pessimism, but by realism and all that that signifies.

It is a new subject opening up a vast field of thought to the earnest scientific researcher, and to the tireless and fearless man of action with the right motives.

But to read it through is not sufficient, even to study it carefully will serve no useful purpose, if not only the subject, but the object to be achieved, the aim, in fact the affair in its entirety, is not visualised in its true perspective.

It must thus be properly introduced.

It may be said that this should have been done in a

Preface. But Prefaces are often regarded by the reader with suspicion, either not read, or read with prejudice, and as this is of paramount importance the author has given it the most prominent position in a first chapter, instead of relegating it to comparative obscurity.

If, however, there are those who still consider that there should have been, or that there should be, a Preface, the author suggests that someone more competent than he should undertake this task. Or, if this suggestion meets neither with approval nor sympathetic response, there is happily another alternative—that the first five numbered paragraphs in the Preface to Herschel's *Astronomy* should be read as a Preface to this book.

Herschel has long since passed but his Preface will live on, it constitutes a bridge over which all must pass in order to assimilate new knowledge; once across it, pride and prejudice will have been cast aside and the mind will be, not merely in a state to receive, but rather to understand new principles, new laws, origin-causes—the substance in place of the shadow—and the reader will continue his researches on virgin soil and finally be made a freeman to that whole estate of knowledge which lies before him.

The researcher who made, developed and applied this discovery is Karl Schappeller, an Austrian, an inspired genius, but with no academic qualifications or social advantages, financial resources or other trappings so necessary to pioneer workers.

For forty years or more he continued his researches undeterred and unafraid, although surrounded by ignorance and prejudice.

Because he refused to give certain powerful but nefarious organisations his secrets, the Austrian Press was paid to dip its pen in vitriol to write scurrilous articles against him.

Subject to every form of attack, he nevertheless “kept his state and refused to come out into this confusion.” As is usual in such cases, frenzied criticisms ran riot, founded on nothing but abysmal ignorance of his work. Wild rumours spread and easily took hold of public imagination.

INTRODUCTION

“Schappeller was an impostor, he had committed every crime in the calendar!”

When the author was asked to make a thorough examination of the matter, he journeyed to Austria, investigated all specific accusations against Schappeller, only to find that there was neither the slightest evidence nor a semblance of truth in any accusation, specific or otherwise, brought against this man.

The author spent, on and off, some three to four years with Schappeller, finally returning for a short visit just before the late war broke out.

Many of the accusers and arch-enemies had disappeared, some for “civil offences,” and rascalities of various kinds.

With the entry of Hitler into Austria the Press of that country had been obliterated, but Schappeller sat as serene and composed as a man could be under the privations and hardships which his fellow-men had inflicted on him, and this without the slightest provocation or cause.

Schappeller, during these long and painful years, never had but one purpose, one goal, one task to achieve—to crown his lifetime of study and experimentation by actually producing and demonstrating the application of the Primary Force (glowing magnetism); in the first instance, to the generation of mechanical power.

Money was raised, but never in sufficient quantity nor under circumstances where it would have been possible for him to carry through the work undisturbed by busybodies, ignoramuses or fanatics. Ultimately, some finance came from this country, but never under conditions which were in keeping with the purpose to be achieved, and indeed it was finally necessary to “overturn the money tables.”

Schappeller made no secret of the fact that the actual production and practical application of the Primary Force to all branches of human activity and to applications beyond those which present Science can even visualise, requires something more than a new plant, *part of which is entirely original*. It requires a new spirit, a new fellowship, to bring this great discovery down to humanity at large, and in

a manner beneficial to all, refuting and refusing every tendency to trusts or monopolies where the life of a community may be sapped for the benefit of a few.

He believed, rightly or wrongly, that that spirit existed somewhere deep down in the British Empire. As early as 1917 he declared that the Allies would win; and immediately after the war set himself as far as his limited facilities and knowledge of our country would allow, to get in touch with what he regarded as the great British people and their Empire or Commonwealth, which extended around the entire globe. Even after studying this book the reason for this will not be clear, but there was a reason, a very sound and important technical reason, which cannot be elaborated here as an advanced knowledge and considerable experience of the subject is necessary to understand it.

Schappeller, about 1936, stated that there would be another world war, when the power would be largely removed from the British Fleet, Britain's bulwark, and that Great Britain would be brought practically to her knees, but something would then happen to save her in order that she could still fulfil her destiny, but not by her material strength alone.

The only thing that could prevent these catastrophes from coming to pass was the offer which he extended to her of the Primary Force if, officially or unofficially, she would give the comparatively trivial help necessary for him to produce it in the first instance.

Official Britain received the offer with scorn and contempt; Britain, the author was informed—it fell to his unhappy lot to make the approach—"had all the protection she needed" and did not require the services of an obscure nonentity. Whereas unofficial Britain was far too busy worshipping the "golden calf"; and all parties concerned were terrified of that weapon which they use so mercilessly against any pioneer or lone and unprotected worker—ridicule. So the offer of this great instrument of peace and protection was rejected, and further decades were to pass before it was to be recognised as such—as it undoubtedly will be.

INTRODUCTION

The trivial sum asked for to complete his work, prove it and demonstrate its application, was refused, but now, everyone must give the half of his income to protect the very existence of the State, not to mention the terrible sacrifice of human life and the indignities and sufferings to which humanity is being subjected.

Apparently no one ever even visualised that to build a new world, in which the fruits of the earth are for all, a new instrument would be required, what Schappeller termed *ein neues Mittel*.

At present we have steam, petrol and other fuels, and electricity. These three are the fulcrums of our entire economic and communal life. The multitude to be fed, not only with food, but with all the essentials necessary to our complicated existence, is no longer five thousand, but nearly two thousand million.

The new instrument is applied through science. But what actually is science? The word "science" is derived from French and Latin and means "knowledge." Now it has come to mean specific, classified, co-ordinated knowledge of the functioning of natural phenomena. At least, this is the author's definition for present Science and technique, but for basic Science, for conscious-physical Science, another and even more precise definition is necessary. Science is the knowledge of the Creator, His essence, substance and functioning through the primary and secondary states of matter; matter in energy form being a derivative out of His primary sublimite, the conscious Ether. This is "creation," and if there is no "creator" there is no creation.

It is from the conscious Ether that the Primary Force is to be derived and harnessed in the service of man—the biomagnetic force—in which the conscious-physical is blended and in complete unity. In the secondary derivatives such as electricity and secondary heat, the "bio" or consciousness is latent and has physical characteristics only, as shown by the electrotechnique and thermodynamics, respectively.

This is really the subject-matter of Part I, which has

been elaborated, developed and correlated with present Physics and chemistry in so far as the functioning of the Primary Laws are discernible in the secondary states of matter through secondary phenomena and by instruments at present available—but commencing, as it should, with the new set of definitions.

Part II deals with the New Technique, based on the new or Primary Physics and Chemistry, just as the present techniques are based on the present physics and chemistry.

Part III is the Medical Section, explaining the curative or therapeutic applications and the new instruments which would be available for diagnosis.

Finally, an Appendix has been added supplementing, by further illustrations, phenomena and matters relevant to those already contained in the book.

Now it may be contended by some, particularly those who have had the Primary Physics explained to them consistently and over a considerable period of time, that the book contains too much reiteration, but it should be obvious, since the book is intended to be a comprehensive work, within the limitations and restrictions imposed by the peculiar conditions and circumstances under which the author had to obtain and elucidate this knowledge, that it must be made comprehensive to those who have never yet even heard of the subject. And the author knows from long years of experience in expounding it, both verbally and through the written word, that the tenets and principles of the Primary Physics cannot be retained and applied except by this very process of constant repetition and reiteration. No man without the aid of the book has ever yet succeeded in grasping and thoroughly assimilating the principles contained therein except through months of constant verbal explanation and repetition combined with similar periods of patient study and reflection.

The principle on which this book is written is therefore intended to be a substitute for verbal tuition, in which the author is constantly prompting the student, assisting his memory, until he has had the time and experience to assimilate all the matter necessary to the proper understanding

INTRODUCTION

of the vast field of thought as it slowly unfolds and develops, and above all, impressing on him that he is dealing in this Physics with the conscious-physical force and all that that implies.

The book is not, and could not be, a physics book, because the Primary Force has not yet actually been produced and demonstrated, and therefore the experiments on a large scale have not been made from which the necessary detailed and accurate data would be available; it will nevertheless serve as a preliminary treatise on the Physics of the Primary State and its Techniques.

The author, for this very reason, and others, was himself averse to writing any book on the subject unless and until the Primary Force had actually been produced and demonstrated, at least to the generation of mechanical power. The other applications would follow afterwards and form specialist branches as the subject developed year by year. In fact, the author has consistently and persistently given his entire efforts, throughout the many years in which he has now been associated with this affair, simply and solely with this purpose in view.

Preliminary data would then have been furnished so that a physics book, on orthodox lines, could have been compiled by those competent to undertake this work—checked and counter-checked by exhaustive experimentation—whereby the new nomenclature and units would have been formulated and applied in formulæ with definiteness and precision, thus expounding and developing the whole mathematics with a clarity approaching that attained in the books on what is termed here the “Secondary Physics,” or Physics of the present day—of which it is said Sir Isaac Newton was the father; a physics which has therefore had over two centuries in which to mature, organise and consolidate its data, and is now recognised as the classic basis of all science, and has indeed been given the appellation of the “exact physics”—nevertheless, *a physics which is still restricted to the functioning of secondary forces and states of matter.*

The 1939 war, however, intervened, and Britain had failed to secure this asset, so the author decided to place this work,

even in its preliminary stage, on record, perhaps to repose in the archives of time for further decades; civilisation preferring, meanwhile, to rely for the protection of its freedom and culture and all that decent men hold sacred, solely on the already crumbling bastions of concrete and steel—to fight the enemy with his own weapons, rather than with one against which he could not fight. Thus we attempt to cure and assuage disease, to mitigate human suffering with devitalised secondary forces, rather than by the utilisation of the great life-giving biomagnetic force which might have been available to the medical profession a decade or more ago; we split the atom instead of, as Nature does, building it up; in fact—if a simile in “optics” is permissible—we follow in each case the “invert image” rather than the “erect”; substituting fear for courage, criticism for study, disbelief for understanding.

To build ourselves a new world we require not only a new instrument but a “new spirit”; in fact, the new spirit must inspire this new world and the new instrument must construct it.

But let us have no illusion about this new world; it will not be the outcome of magic, but of “motive.” In one respect it will therefore be like the present one—exactly what we make it.

A temple cannot be built and then sanctified. Whatever measure of sanctity, if any, it is to have, is in the motive and purpose, spiritual or otherwise, of its founders. If it is to be built to the aggrandisement of an age or epoch, it will serve this purpose and this purpose only, and be admired and worshipped as a triumph of that era until the finger of time destroys it. If, however, it were built and dedicated by man to his Creator, not in mere words—that alone has no “energy value”—but in motive and deed—even if the temple itself were never constructed in stone, therein would reside the spirit, the motive, the motive power, the creator of the new world we wish to build.

When the right spirit is there the instrument will be available and man can then use and apply it to his needs, to make his deserts prolific, to increase and gather his harvests, to

INTRODUCTION

feed the multitude throughout the world, to cure the sick, to punish the offender, to protect the oppressed, to suppress the aggressor, and generally, to bring about peace and goodwill on earth—but with one proviso—that these and the like are man's only motives in using it.

When the right motives are there, the New Age will dawn, and the new instrument with which to construct a new and better world will at last be recognised and gratefully accepted.

CHAPTER II

THE NOMENCLATURE WITH NEW DEFINITIONS

It will be clear that a new departure or discipline in basic physics, and much more so in the physics of the original or Primary State, and its functioning, will require a new nomenclature.

This new nomenclature does not necessarily mean the coining always of new words, but in many cases giving the old familiar words and phrases their full and their original meaning—for example, cosmos, ether, vacuum, magnetism, biomagnetism, force, energy, entropy, ectopy, electopy, fluidum, material, static, dynamic, mobile, inertia, gravitation, transpiration, sublimate, air, water, light, heat, entity, entity-force, atom, atomus, tomistic, stress, stressfield, cohesive force, gravity, weight, matter, atmosphere, etc.

Let us examine each of these, not necessarily in their present order, but in the sequence required for the best elucidation of the subject.

Scientists have sometimes contended that Schappeller has “stolen their thunder,” filched their words and phrases, giving them meanings to suit his own purpose. We will therefore examine into Schappeller’s justifications for his use of present words and phrases, and also whether his new ones are well balanced, expressive, qualified and restrained, remembering always that no one can own words any more than he can own the landscape.

These definitions are intended only for rapid reference; the text should be referred to for amplification. Furthermore, they will not be fully understood until the text has been mastered. Only the principal definitions have been given.

ABBREVIATIONS USED

Dictionary Definition	Dic. Def.
The Physics of the Primary State or the Primary Physics }	PP.
The Primary Force	PF.
Present or Secondary Physics (because it deals with the secondary states of matter and their functioning) }	SP.

DEFINITIONS

Cosmos. Harmony, any self inclusive system characterised by order or harmony amid complexity of detail (a Dic. Def.).

PP. An ordered system of finite extent and spherical form, formed out of ultra-Space.

Space (Cosmic). PP. Extent in cosmos.

Space (used in the sense of Cosmic Force). PP. Includes texture of cosmos, the Ether.

Space-Force (Static). PP. Static Potential.

Space-Force (Dynamic). PP. Primary Magnetism.

Mobile (Mobility). Something which occasions movement or action—a mobile part of a machine—something which can move (Dic. Def.).

PP. Usually signifies energy exchange in Primary Magnetism or transpiration between two stressfields.

Vacuum. Empty, space without air, *Luftleerer Raum* (German). “Nature abhors a vacuum”—space without air—says Science.

PP. "Empty space" does not exist—the texture of space is "the Ether"—the original energy material from which all substances are derived. Nature does not abhor a vacuum, she functions only with vacua. A space without air is not "empty," it is filled with the ether. In the technique a vacuum is a space without air but filled with ether. In the PP. a primary vacuum is the densest filling space can have, *e.g.* the Sun.

PP. Def. A vacuum is the densification of the ether to the glowing state occasioning the greatest mobility and transpiration possible within the cosmos. In other words, the vacuum is the greatest suction force within the cosmos.

Vacuum (Secondary). Space without air, likewise a suction force, hence the use of the word in the PP.

Ether. That one of the elements which, according to Aristotle, forms the material of the heavenly spheres and bodies from the Moon to the fixed stars (Dic. Def.).

PP. The Ether is the texture of Space, that of which Space is composed.

Transpiration. Breathing (Dic. Def.).

PP. That which occasions Mobility between Stressfields—suction or attraction between Stressfields through energy exchange.

Stressfields. PP. An energy-stimulated space or area—the form or shape of the Stressfield being determined by the source of stimulation, *e.g.* a primary Stressfield, ether-stimulated space occasioned by the Sun, Earth or any other heavenly body. A secondary Stressfield is that occasioned by an artificial source, *e.g.* a gauss or electrostatic field, a light Stressfield from some light source, a heat or sound Stressfield, in fact any ordered static stimulation of the ether or air. A primary Stressfield occasions transpiration and mobility (energy-exchange). In materials (solids) the

Stressfield is latent equalised out cohesive force, giving tension, compression and shear properties to material.

Magnetism. A force of attraction (Dic. Def.).

PP. Suction exerted in "energy-form" is a force of attraction.

PP. Def. That which promotes and exerts interpolar exchange. In the Primary Magnet the form is spherical.

Biomagnetism. The Ether is conscious-stimulated; if it were not, no life could be propagated. Primary Magnetism is therefore conscious or biomagnetic, but not life in form.

This is difficult; no direct definition or explanation is possible at this stage, but assimilation of the whole subject will make it clearer.

Latent Magnetism. PP. Unstimulated unpolarised magnetism. The Ether as a static potential before polarisation of its two components (H and O in energy-form).

Electricity. Derived from the word *electrum* (amber)—owing to the production of this energy from amber (Dic. Def.).

PP. Unpolarised magnetism (but this requires further qualification according to form).

Electric Current. PP. Latent magnetism—highly potentised and compressed—*e.g.* stimulated highly-potentised compressed magnetism.

Force. Strength or power, vigour, might (Dic. Def.).

PP. Def. The primary state or condition of matter capable of action.

PP. Here a new word has been coined—Might (*Macht*, German). It means potential, static potential, available energy. A source for release of energy. A latent potential difference awaiting the corresponding catalyst. When the catalyst is available, then

the Might or Potential is transformed into active force or energy-exchange.

Energy. PP. Is a release out of force. Force and energy are a cycle. Energy itself is the static texture of the Ether as potential. Force (or Might) is the static condition of the Ether, better termed "Static Potential."

Energy is a sublimate out of Force. Static Potential is Force or Potential or Might, before its release into mobile energy.

Cycle. In colloquial language it means a recurring series of changes in some operation, *e.g.* the seasons of the year; in thermodynamics (the Carnot, Rankine, Otto cycles, etc.), a series of operations in a cylinder. But in the cosmos there are no cylinders.

PP. Def. A cycle of energy-operations through a catalyst functioning a potential difference.

Inertia. Means idle, a property of matter tending to prevent motion, or when matter is in motion to resist any change of motion (Dic. Def.).

PP. No such property of matter exists—it is not an internal, but an externally induced property. It is not a static property of matter or material, but the result of dynamic induction, through the crossing of the stressfield—earth's stressfield with the cohesive force of the material in question.

SP. There are two kinds of inertia, says Science—linear and rotary.

Linear inertia is proportional to the mass of the body, but Rotary inertia depends also on the distribution of the mass about the axis of rotation.

PP. Naturally so, because in Linear inertia the induction of the earth's stressfield due to acceleration or deceleration is equally distributed throughout the mass of the body, whereas in Rotary inertia this is not the case.

Induction. PP. Def. The penetration of energy into matter, *i.e.* into the static energy in material.

Mass (as energy). (*Masse*, German.)

PP. Def. Mass is Force in a bound condition, before it is brought to the glowing state.

Matter (as energy). (*Stoff*, German.)

PP. Def. Matter is mass with form—materialised energy—energy material, *e.g.* glowing magnetism.

Material. PP. Def. Mass and Matter are both Energy but not Material. Material is a growth between two potential differences; example: the earth's crust. The process is too complex to explain here as a definition. Energy builds, gives and maintains form in materials.

Sublimate. PP. Def. A sublimate is a condensate out of something.

A sublimate may be in fluid form: it is then an ion; in solid form, it is a substance; it may also be in gaseous or energy form.

The air is a gaseous sublimate out of the atmospheric stressfield. The Sun is a fundamental energy sublimate (matter) out of the Ether.

Electricity may be regarded as a kind of sublimate out of magnetism—a fluid form of energy, a fluidum.

Fluidum. PP. Def. Energy with mass. Magnetism has too much energy and not enough mass to be regarded as fluidum, *e.g.* a wattless current is not fluidum, it is merely a stress which is being moved, not a mobile but a dynamic stress, and even then only in the sense that it is being moved. Volts are simply a stress when wattless. Amps are densified volts. This is important in the new technique.

Atom. (*Atomus*, Latin.) Indivisible (Dic. Def.).

PP. Def. Atom, Atomus, Tom, tomistic—a dome.

Atomus. PP. Def. The creative entity in the centre, *e.g.* the Sun.

Tomistic. PP. Def. The Potential Difference or force of attraction between this physical centre or entity and its corresponding oxygen stressfield.

The Atom. PP. Def. This is the whole. The atom in the PP. is therefore the living atom of Nature, not merely a convenient schematic planetary supposition of electrons revolving round a nucleus. The definition of Democritus is: An atom is a dense entity whose space is empty.

Schappeller's definition is: An atom is a dense entity whose space is vacuum.

Goethe says: *Kern und Schale beides auf eine Male.* Translated freely, this means that the kernel and the shell functioning as a whole constitutes the nut; in this case it is the hydrogen core in the glowing state and its cold complementary surrounding oxygen stressfield, the living atom! No other exists in Nature, it is the creative entity of life energy or biomagnetism.

Atomic. PP. Def. Complete.

Atonic. PP. Def. Incomplete.

Agens. A faculty or state of acting or of exerting power—an agent or instrument (Dic. Def.).

PP. Def. An agens is the driving force which an entity possesses, but only when it is between the fundamental potential difference. (This applies to the Primary State.) Examples: the so-called waves in radio are an agens, likewise the *energy* impregnations in a gramophone record.

These are two examples in the techniques of to-day. The agens in the PP. requires elaborate explanation and extensive knowledge of the subject before it will be understood.

Entity. A real being whether in thought (as an ideal conception) or in fact; a being, essence or existence (Dic. Def.).

PP. Def. An energy creation—a condition of the energies with form, an entity. In the secondary condition an organism, life with form.

Electron. Amber, electrum (Dic. Def.).

PP. Def. An electron is a specifically charged hydrogen and oxygen energy globule.

Gravity. Heavy (Dic. Def.).

For PP. Def. see Weight.

Gravitation. That species of attraction by which all particles of matter tend towards one another (Dic. Def.).

PP. This is an entirely false notion. The attraction between bodies is conditional. Gravitation is explained in the text, but see also definition of Weight.

Air. Any gaseous envelope (Dic. Def.).

Atmosphere. This may be translated from the Greek as the breath-sphere, the breathing-sphere.

Air. PP. Def. Air is a sublimate out of the atmospheric stressfield, itself being a stressfield of oxygen and hydrogen energy; here air is oxygen and hydrogen, but in this sublimate it is changed, as a sublimate is not a polarisation product, but a separation or condensation product whereby polarity ceases, the hydrogen no longer constituting a pole, as change of state takes place—change to the gaseous state—whereby the hydrogen takes on a neutral form and is known as nitrogen, plus a residue from this transformation, viz. the noble gases.

Atmosphere. Throughout the PP. this refers to the stressfield round the earth, arising from the central hydrogen core and extending for millions of miles of which, as above explained, the air is a sublimate or a condensate in gaseous form—a compression product out of the atmospheric stressfield, in form an envelope bound to the earth's periphery.

Water. PP. Def. A further sublimate in liquid form, the third state of matter.

A chemical combination of hydrogen and oxygen in the third state of matter—the residue here is really deuterium.

Since water is H and O and since it is a sublimate out of the atmospheric stressfield, which in its turn is merely “stimulated ether,” which is also H and O energy, and since H and O when functioning by polarity is magnetism, water must be liquid magnetism in the latent state, *i.e.* latent liquid magnetism. It cannot exert any exterior attractive force because its H and O polarity is merged as a homogeneous stressfield and this constitutes the cohesive force of water. It is a stressfield equalised out by polarity and is thus externally in a neutral state—internally its force of attraction operates as cohesive force.

Cohesive Force. PP. Def. The equalised out bipolarity of the stressfield which compacts and brings matter to the third and fourth states and gives form.

Light and Heat. Conditions of energy, compression products, functioning expansively.

Gravity or Weight. SP. Def. The pull of the earth on mass. PP. If the negative sign were given to this, it would be very close to the basic truth. The earth or any heavenly body has no weight relative to the cosmos because the “glowing magnetism” reacts upon the ether and lifts or neutralises the weight. This means that the force exerted by the hydrogen core against the surrounding ether stressfield, neutralises the so-called weight, or carries the heavenly body. This fundamental principle can be applied in the new technique and is explained later.

Furthermore, it means that the force of one kind of gravitation, primary gravitation, must have a negative sign since it functions outwards.

The weight or gravitational value of a mass (material) is the energy stress that would be required to suspend it in the air. The calculation remains the same as in the SP., but the original cause or principle is different. However, this is a matter for the new technique and requires a complete chapter.

Energy-Membrane. PP. Def. The word "membrane" has, up to the present, only been applied to the secondary states of matter, principally, if not entirely, in anatomy. Hence the reason that it is qualified here as *energy-membrane*, signifying an energy frame or membrane of infinite sensitivity, supporting static stress and likewise energy transference.

Polarisation. PP. Def. The separation of two components with mobility, that is, constituting bipolar form with a neutral centre—the three essentials of any bipolar system, viz. two poles and a neutral.

Ectopy. PP. Def. Energy arising or springing from an external source. This can only be understood from the text.

Electopy. PP. Def. Electricity or electromagnetism arising or springing from a circumference to its corresponding centre.

Implosion. PP. Def. Ignition to, instead of from, a centre as in explosion.

Impression. PP. Def. The impregnation product from implosion—a sun or other variant, but in all cases a spherical hydrogen core brought to the glowing state by compression and thus intense densification beyond the critical point, when a permanent "impression" is made involving change of condition to the glowing state.

CHAPTER III

CREATION

Some philosophers declare that Nature possesses something in her which has the power to create. This is an obvious truism, but falsely expressed—furthermore, it is begging the question. It is an evasion of the problem, rather than a solution of it.

The SP has no oracle to utter on this, the most basic and fundamental question of all, viz. what creates in Nature?

A dictionary definition of the word "creation" is, "The act of causing to exist, or fact of being brought into existence by Divine power, or its equivalent."

Locke says: "As when a new particle of matter doth begin to exist—which had before no being; and this we call *creation*."

"Creationism" is defined in a dictionary as being "the doctrine that a world came into being out of nothing through an act (or a series of acts) of a transcendent creator."

(PP.) This statement is, of course, a direct contradiction. If the world came into being through an act of a transcendent creator, the stuff of which the world was built and its functioning are both the product of an All-Pervading Consciousness, and it was thus created out of Consciousness.

Science is asking, "Where and when did life enter into the scheme of things?"

The answer lies in the proper understanding of life and what life actually signifies.

Let us therefore have done with this philosophical speculation and examine the facts before us, basically.

If something has been created, and we know definitely

that it has, then no "thing" could have created it—dead matter cannot create anything. Not even an entity nor a spiritual entity can create, because an entity must itself be created—it is itself a creation.

The Creator cannot therefore be an entity or a spirit, but must be an All-Pervading Consciousness which saturates the Ether and Space or Extent in its infinite totality, of which our Universe or Cosmos is a particle.

Thus there could not be more than one Creator because a creator would then be partial and not total nor all-pervading. If there were more than one, then each one would be an entity, and as entities they could rule, but not create.

Nothing, therefore, can create but a creator, and nothing can create a creator. Because whatever created a creator is the Creator, and if there is more than one, they must have been created. So the All-Pervading Consciousness is the Creator—and there is only one.

This branch of the PP. is not concerned with the spiritual laws or moral issues.

The important points derived from this are, that the Cosmos or Universe is saturated with this Consciousness and functions on the Creator's plan, which we term "the laws of Nature." A physics which does not understand and ignores Consciousness is itself fundamentally sterile, and can only be used as a guide to the techniques.

Life did not enter into the scheme of things. Organic life is created out of entities, and entities are products of consciousness, conscious-energy and life-force or bio-magnetism, and the life-force is derived from the All-Pervading Consciousness or the Creator. In other words, the definition of fundamental or "origin-consciousness" is the Creator. There is no such thing as "original consciousness"—because this would imply that the Creator had been created, whereas He must always have been and always be, for He is the origin of all consciousness, or Origin-Consciousness.

CHAPTER IV

THE COSMOS

Space as such is infinite and our Cosmos or Universe may be considered as a particle of space, having form—spherical form—and being, of course, finite in extent.

Outside the Cosmos is the storehouse of energy in latent, unstimulated form, and infinite in extent, but here also is the All-Pervading Consciousness, as latent Consciousness.

Purely as a simile and for illustrating this only, one may regard this as the kind of consciousness felt or available from, say, the books in a library. There is "potential" in the books, but potential difference only when a reader consults one. When the remanent consciousness in the book and the consciousness of the reader (on the particular subject under consideration) have equalised out, the potential difference has been disseminated, and in this case the book is replaced. The remanent consciousness in books, papers, maps, photographs, etc. is due to the energy impregnations on the cohesive force of their respective materials induced through the thought-force. But we must not carry this simile too far, because in Space we are not dealing merely with remanent consciousness, but with the All-Pervading Consciousness Who functions on an "utter plan" and draws on His static Self as and when He requires, not as entity, but as Universality.

The utter origin, the infinite Space beyond the Cosmos, the origin stuff, *the product of the Creator's Consciousness* in which He, the All-Pervading Consciousness, is at rest, is expressed here, in our present language, as carbon energy static. It might be termed a "latent potential." Creation in the first stage means the forming of a universe or cosmos,

where the laws as laid down by the Creator can function; where life-energy can operate; life-entities, origin life in the primary or "energy-form," can be created and exist; where worlds can be formed and where life can be transformed from the entity to the organism.

*THE FORMATION OF A COSMOS, UNIVERSE
OR ETHER-SPACE*

The thought-force of the Creator can produce in the homogeneous static latent potential a point of inequality which forms in infinite Space a finite sphere of stimulation tensioned to the point of inequality, and this is what we term a universe or cosmos.

This finite universe or cosmos is, as a whole, a point of inequality, relatively to the homogeneous static latent potential of infinite Space.

The texture is now stimulated or tensioned static latent potential, which we term here "the Ether."

The Ether is thus conscious-physical and is the "energy soil" from which cosmic bodies are formed as and when the right conditions are present, determined by the conscious Time Factor and Ether functioning, the whole originating from the thought-force of the Creator.

This formation of a universe or cosmos—and there may be many such—is the **FIRST CREATION**, or the first stage of creation.

THE FUNCTION OF THE ETHER

We have now a stimulated static potential having Space-form, a carbon static potential, of the nature of an "energy-membrane" (see Def.). In other words, the condition of Space (finite) is that of an energy-membrane, the texture being that from which it came, a latent carbon static potential; but in finite Space or the cosmos it is stimulated or tensioned, forming a spherical cosmos or universe. A homogeneous static carbon potential in the condition of a universal all-

pervading energy-membrane forming a whole universe or cosmos—this is the texture of Space, known under the name of “the Ether,” and which is capable of supporting stress and transference of energy.

*THE FUNCTIONING OF THE ETHER IN A
UNIVERSE OR COSMOS*

So much for the formation of the Ether, which pervades all Space in a universe or cosmos, and now let us consider how the Ether itself functions in the cosmos.

Once again, the functioning of the Ether depends on a point of inequality being formed in the stimulated homogeneous static potential. This time, however, it occurs through what we usually term “physical means”; the actual process is explained in Chapter VI.

It was previously stated that the cosmos was a sphere of stimulation to a central point, the point where the inequality was formed. This means, in the case of the cosmos, the formation of a tensioned energy-membrane, at rest as such, but tuned and capable of stimulation or super-imposition of energy, that is, the formation of the all-pervading Ether.

Now consider a point of inequality in the Ether, itself, that is in the Cosmos or Universe, which it is now considered has been formed out of the storehouse or infinite Space.

The stimulation or super-imposition of this stimulation causes the carbon energy static to separate out into its two component parts, known to us under the names of hydrogen and oxygen energy (not gases).

But this separation of the two components must follow a definite law, otherwise it cannot constitute and function as a force. The separation must be polarisation, and this is known in the PP as the centripetal action of the Ether. The hydrogen component, as it separates, forms a point of inequality radially by exerting attraction upon itself, this produces densification and finally, under enormous compressive pressure, light-matter is formed by “implosion,” “impression” follows, and what we term a sun or other

variant is formed. The formation of basic cosmic bodies (suns or other variants) from ether as material in a cosmos, as tensioned Space-form, constitutes *the second stage of creation*.

It is legitimate to term it centripetal action, because centripetal force in the SP functions radially to a centre, although the origin in the SP of this force is the revolution of mass round the centre in question, and is expressed by the formula mv^2/r . It will be obvious that this formula cannot hold here. A different mathematical treatment will be required. A sun or glowing sphere of hydrogen is really a sublimate, concentrate or precipitate in energy form out of the Ether. For it is an axiom in the PP that *everything must be composed only of what was there or what was available*. This might be termed the first axiom in the PP.

Each "new order" may, through successive polarisations and later on other forms of separation, and finally permutations of these separations, produce or generate new variations of the fundamentals, oxygen and hydrogen, derived from carbon energy; but the old adage, "There is nothing new under the sun," or perhaps better expressed, "There is nothing new *in* the sun," is true, because the sun is a sublimate out of what was there, the ether, the carbon static potential.

Electrolysis is really the polar production of sublimates, and so for this fundamental or cosmic centripetal action we should perhaps look for our mathematical solution in this direction. The sun is therefore a negative fire formed negatively by implosion instead of by explosion, and out of contact with air instead of in contact with it.

We must now carefully consider the full significance of Newton's Third Law of Motion, viz. to every action there is always an equal and opposite reaction; or the mutual actions of any two bodies are always equally and oppositely directed.

The sun, as we see, was formed by compression, resulting in the densification of the hydrogen component, and to such an extent that it is brought to the glowing state. (Light-matter is formed by "energy-compression"—dealt with later.)

Here again, we have a new axiom, or rather the old one applies in another form: *the energy which any body possesses can only be a product of its energy of formation.*

Taking this second axiom and Newton's Third Law together, we can find the solution to the sun's functioning. The energy of formation was "compression," and Newton's Third Law declares that wherever there is action there must be reaction and that this is equal and opposite; if the energy of formation was "compressive," then by Newton's Third Law the reaction must be "expansive," and when energy operates expansively we term it "radiation." Compression, therefore, is the origin-force of all radiation.

Much wild speculation has been made as to the source and cause of the sun's radiation. It was possible to ring the changes on three factors, viz. the rate of the sun's radiation, its probable age and original size, and finally, out of the conjurer's bag, emerged either the probable age of the sun or its original size—"the cart before the horse." The first consideration could not be that the sun was "losing energy," but rather how it was ever formed, and thus, from whence it obtained its energy.

The further statement that as the sun is losing energy it must be getting smaller, can also be fallacious. If the formation, functioning and nature of the sun are properly understood, an alternative presents itself, viz. that the sun is "feeding."

The other suggestion, or rather desultory speculation, that the sun's upkeep of energy is due probably to some form of transmutation of hydrogen is fantastic. Transmutation is conversion of energy, sometimes implying alteration in state or form, but it is not a permanent source of energy. Furthermore, the statement is made without any attempt to show where the hydrogen originated or in what form it was.

The suggestion that the sun radiates energy because it is hot is again begging the question, because the problem then arises, from whence came the source of the sun's heat?—and this even before it has been established that the sun is hot, or what heat in the primary state really signifies.

The purpose of this and other criticisms here is not

and will not be merely to criticise present Science, but to indicate to us what line we must follow in order that we may substitute for speculation and guessing, a basic examination of the subject.

Let us suppose that the earth revolves round the sun, or that the sun revolves round the earth, and that the earth revolves on its own axis; here again, we can ring the changes between the various forms of relative motions, and this is what is meant by "speculative reasoning," ignoring the apparently unimportant details and "sweeping on" in each case to what may be the grand fallacy.

Whereas a basic examination admits of no suppositions; it at once demands that motion, if such exists in any heavenly body, must be established, that is, where the energy comes from to produce such motion, what form the motion must take and its exact nature, and in which body and for how long it can be sustained, and likewise whether the motion is free and unrestrained, or constrained and defined, and if so, by what, and under what conditions.

Now the first basic point to settle is which state of matter is primary—the solid, liquid or gaseous.

It has been suggested that the earth has a solid core, or that it is probably a liquid core, and this without ever considering the function which the core of any heavenly body must perform.

Science has apparently now reached the stage when it considers that the primary state of matter is neither solid, liquid nor gaseous, but "energy," but without being able to define where or in what form this "basic energy state" is to be found.

Since everything was derived from "energy," and the only available energy material not merely was, but still is, the Ether—the homogeneous static potential—it follows that the sun is a polarisation product out of the Ether, the two components of the Ether—hydrogen and oxygen—forming the two poles, the hydrogen the core and the oxygen the surrounding and complementary stressfield. How this takes place has already been explained in brief on page 42, paragraph 3, and more fully in Chapter VI.

Now in the airy and romantic description of how worlds were formed, which is usually illustrated with plausible and fascinating, but highly imaginative pictures, it is interesting to note the obvious importance given to vapours and water in the evolution of new worlds or heavenly bodies, but without any basic evidence of what vapour is in the fundamental state or how it is formed in the first instance.

Water or vapour is hydrogen and oxygen, but apparently only when chemically combined. Two parts of hydrogen and one of oxygen gas is merely a mechanical mixture of these two gases. The Germans call it *Knallgas*, we have no special name for it. It is, or it should be, an interesting scientific fact that to bring these two gases to water requires fire. In other words, they must be burnt, then they are said to be chemically combined, but even then without any explanation as to what has actually taken place. If Science says the energy form or energy is the basic state of matter, and it obviously is, the hydrogen and oxygen must first exist in this form before they could be clothed as gases, and chemical combination is merely the combining of the energies of the constituents in question, in this case hydrogen and oxygen energies, and this is done through fire. Therefore, the first state of water or vapour is oxygen and hydrogen energy and the first condition of water is fire—hydrogen fire, negative fire.

Now we have explained that the carbon static potential of Space (the Ether) is a homogeneous mixture of its two components, hydrogen and oxygen energy, and that the sun must be derived from what was there and nothing else; therefore the sun is a hydrogen fire surrounded by its oxygen stressfield; both, of course, are in the energy form.

The necessary ingredients are now there as fuel for the fire, since all fuels contain carbon, hydrogen and oxygen, and thus also the two ingredients and the condition to produce the first vapours and finally water on the sun's periphery.

If the static potential Space, or the Ether, were anything else but that above stated, no fuel or ingredients for moisture would be available and no sun could be formed.

If the separation of the constituents of the Ether were not bipolar the sun could neither form nor function. This is of basic importance (explained page 42, paragraph 3 *et seq.*, also Chapter VI).

The Ether and the sun are therefore identical in composition because the latter is a product or sublimate out of the former, that is, the sun is an Ether sublimate. We therefore have two likes, the Ether (space texture—static potential) and the sun, but in unlike condition, the one being a static potential, the other constituting a bipolar system, with mobile interchange causing a force of attraction, and here we have the primary magnet, primary magnetism. Since, as previously explained, the Ether is stimulated with Consciousness from the All-Pervading Consciousness, this primary magnetism or magnet of pure energy is life energy or biomagnetism and is the source from which all organic life is born, energised, and whereby it is sustained.

This glowing hydrogen core is therefore termed “glowing magnetism” and is actually the Primary Force in all Nature, which means that the ether or static potential of Space is latent cold unpolarised magnetism.

If the Ether were not latent magnetism then no such thing as polarised magnetism could exist.

“Magnetic action is independent of the pressure of air and occurs also in a vacuum. Hence magnetism is a state of space devoid of matter, *i.e.* a state of the ether.” (Page 111, Vol. III, of Grimsehl’s five-volume *Textbook on Physics*, 1933.)

This statement merely serves to show that German physicists some ten years ago were coming to the conclusion that the ether was magnetism in some form, although they were only led to this from secondary considerations and not from primary analysis. From whence this magnetism was derived, its nature and functioning, as likewise the primary vacuum, was unknown to them, as it is even to Science at the present day.

SUMMARY

The cosmos is really densified ether out of the infinite storehouse of Space, in which it is anchored as the interior space of a sphere, thus supplying the material for dynamic action—formation of cosmic bodies.

The texture or composition of this confined space, cosmos or universe is a carbon energy potential; there is no other source or origin. This is the equivalent in the SP of a basic element, but it is not an element, since if it is a true element it cannot function of itself, and if there is more than one it cannot be an element.

In Nature there is, therefore, no such thing as an element, only an "elemental state," which we term the "elemental," and the elemental is capable of polarisation into its two components, oxygen and hydrogen energy, through the centripetal action of the hydrogen component separating out and forming by densification a physical centre or pole wherever a point of inequality has, through an agency exterior to this point, formed, or rather the hydrogen component at this point of inequality in the otherwise homogeneous carbon static potential, through enormous densification due to its characteristic of exerting attraction upon itself, produces light-matter and thus brings itself to the glowing state, when it is termed "glowing magnetism."

Specific Space, that is, a cosmos, is thus conditional to form, which is spherical. The whole of the ether of specific space or cosmos is the force of cohesion, but in the free, unbound condition.

The ultra-Space is really latent carbon force in the free state, but when densified, as in the cosmos, it is carbon energy static potential, supplying the material for formation of cosmic bodies.

Ultra-Space is not ether because it is not tensioned or controlled as Space-form; ether is specific, formed, stimulated, the static potential of a cosmos, latent biomagnetism, of which, when polarised, the hydrogen component through tremendous densification is brought to the glowing state

and termed "glowing magnetism," the true biomagnetic static force, the Primary Force in all Nature.

If we are given a sphere, and from its surface work backwards to determine its geometrical centre, we have found its origin. Now, suppose instead of a metal or material sphere we consider a sphere of energy or a spherical stressfield, then it follows that this has also a geometrical centre, but the geometrical centre must in this case be also a physical centre, otherwise the stressfield as such could not be generated or maintained.

Here the physical centre is the hydrogen core of the sun, which, together with its surrounding complementary stressfield, constitutes a primary vacuum. A vacuum has really no centre, it is itself the centre, the physical centre or origin of a given stressfield, which it occasions, as we shall see later.

The geometrical and physical centre of a cosmos must always be the point to which the whole cosmos is "tensioned," maintaining its Space-form as a cosmos or universe. (See first and last paragraphs, page 41.)

The geometrical and physical centre of a sun or other variant is its glowing hydrogen core, but a primary vacuum as such has really no physical centre because it is always in mobile exchange.

CHAPTER V

THE VACUUM

In order to understand the functioning of the sun and why it is legitimate to term the glowing hydrogen component of the Ether when conglobated "glowing magnetism," it is necessary to grasp what a vacuum really is and what it signifies. (See Chapter II, page 29 *et seq.*, Vacuum.)

In the SP a vacuum means a space without air, a partial vacuum being a space possessing less than the normal quantity or pressure of air. On the other hand, just as magnetism in the SP is described as a "force of attraction," vacuum is said to exert a suction force, Science explaining that this suction force arises from the greater or full normal air pressure acting on the lesser air pressure within the vacuum area. This is tied down "once and for all" by mathematical calculations, and experimentally through the instrument known as the barometer, and Science thus rests assured that here at least the matter is quite simple.

But here co-incidence (*not* coincidence) has, as is so often the case in experimental physics, screened the true facts; the shadow has been mistaken for the substance.

The barometer does not measure the weight of the column of air as weight, but as stress. The substance and the shadow run co-incidentally, this fact making no difference to the engineer or even to the experimental physicist, provided the latter is not examining or researching for the origin or primary laws.

Vacuum, as we have seen, is "empty space," but empty space is not necessarily vacuum. Wherever there is air there must be vacuum, but wherever there is vacuum there is not necessarily air. Because air, as we have seen, is a compressive product out of the atmospheric stressfield; the

origin or primary vacuum exists therefore in some form in space itself.

Weight can only operate vertically towards the earth and the air is not a nearly incompressible medium such as water; but the atmospheric stressfield varies inversely as the square of the distance from the centre of the earth, and arises from the glowing magnetism central core after a sun has formed a crust and become an earth. This is the source of terrestrial magnetism.

The magnetic field cannot exist without a source of magnetism. Science is at present guessing as to what is at the centre of the earth—an iron core, nickel steel or a liquid, none of which would constitute the source of magnetism nor perform the primary function for a living earth, and a dead earth could not form and support life. (See Chapter XXVI, Gravitation.)

When the density or intensity of densification of the central core reduces below a certain critical point (because, unlike when it was a sun, it cannot, owing to its crust, feed on its surrounding stressfield), it cannot any longer produce its two primary sublimates, essential to life, air and water; it becomes what we term a "moon"; finally, as the process of the central core's deterioration continues, it fails to hold as a heavenly body and disintegrates.

The biomagnetic stressfield, arising from the earth's central core, permeates the crust and extends to a vast distance beyond the periphery, the earth deriving its sublimate—air—at its periphery through this permeation—the biomagnetic core, in conjunction with external cosmic influences, being the ultimate origin of all meteorological conditions.

Briefly stated, the core functions the "interior water cycle" of the earth, which takes place in the "energy form," and this interior water cycle functions an "exterior water cycle," which latter gives rise to the meteorological conditions with which we are familiar.

What is at present termed "atmospheric electricity" owes its origin and maintenance to this stressfield from the core, although conditions may exist when it is converted

into static electricity, or by compression of this magnetic field through "point contact" instruments.

This is the answer to the great problem with which meteorologists are still confronted, viz. how the earth's electric charge is maintained, and furthermore, the even more basic problem which *should* confront them, from whence does this so-called electric charge originate—the point being that the origin stressfield is *magnetism* and not electricity.

Thus what is at present termed atmospheric electricity is really another method of measuring the earth's stressfield, but in electrical pressure, whereas the barometer registers it in weight. Actually, the earth's stressfield is a magnetic stressfield, but the instruments used, once again, convert the substance into the shadow and show electrical charge in volts.

The barometer measures this stress, but the shadow, that is the air, as what is termed weight, exactly follows the substance (the stress) and the calculation coincides with the atmospheric stress, thus screening the true origin or cause, which is stress and not weight. (See Chapter XXVI, Gravitation, Equipotentials.)

The so-called force of suction is vastly greater than that attributed to it, viz. 15 lbs. per sq. in., but not under the conditions in which it is normally formed through the medium of a plunger within a cylindrical closed space, known as a plunger pump. The plunger forms a vacuum force, but in very imperfect form—because it is not spherical—and experiments here, if properly carried out, could show the colossal force of even this imperfect vacuum. Threads of glass were actually torn out of a glass tube in a plunger-formed vacuum during experiments in Vienna.

If we take a glass sphere, or a metal sphere, and exhaust the air, it must not be overlooked that the sphere now devoid of air is still filled with ether. There is a force acting towards the geometrical centre of the sphere, which cannot possibly arise from the exterior air pressure, as the exhausted sphere has no connection with the exterior air. But in the moment that the air is removed, the exterior ether density will pene-

trate and equalise out with the interior density of the sphere. But, as has been explained, the force towards the centre of the sphere is ether pressure or suction and does not therefore depend on the relative ether densities between the exterior and interior of the sphere.

Within the sphere we have thus still the radial pull in every direction, or a universal centripetal pull exerted on the cohesive force of the material of which the sphere is made, which cohesive force is also vacuum force—hence the “hold” which the ether pull has on the material of the sphere—and this is, of course, exerted to the geometrical centre of the sphere. (See also paragraph 5, next page.)

To make this clearer, whilst the air is being exhausted from a sphere, the ether (which is always present within the air) is drawn or sucked in due to the potential difference between the warm ether in the exhausted sphere and the cold ether surrounding it; as soon as the air is exhausted and the pump or exhausting apparatus is stopped this potential difference becomes zero, but the ether-suction from periphery to the centre remains.

Furthermore, a professor of physics proved by experiment that the quality of this vacuum force varied with the material of which the sphere was made, *e.g.* whether of gold, silver, copper, steel, etc.

Thus there are different qualities of vacua according to the material of the spherical containers, the material of which acts as a filter on the inflowing ether; the ether in the case of each specific material retaining a corresponding specific characteristic, much in the same way as white light passing various colour filters retains, in each case, only the light of a corresponding wave-length. If, therefore, a vacuum is produced in a sphere of iron or steel, we have one quality of vacuum, that is, of latent magnetism, and this will be relatively coarse magnetism; whereas if the metal sphere were made of gold, the vacuum produced therein would be relatively finer, and this principle has been definitely proven by a professor of physics.

This is occasioned by the evolution of the entity of the material, the successive processes from the “energy state”

which have formed the respective so-called present elements. Herein lies one of the great secrets in Schappeller's work. Schappeller claims to be able to apply this industrially.

An evacuated sphere is not a true vacuum but only a latent vacuum, the equivalent of a latent electronic volt stress.

A "secondary vacuum," or a space without air, has therefore only ether stress—carbon static potential, but with "form."

Here we arrive at a very important truth, viz. that Space, as such, is not vacuum, but ether is the texture of latent vacuum only when formed, and everything in Nature always takes the spherical shape unless distorted by external influences. In other words, the vastness of space is without air, but it is not vacuum or even latent vacuum unless it is spherically controlled and formed, as an area of stress or a "stress area"—a Cosmos.

Now, no such vacuum in latent form dependent on the spherical wall of solid substance, the cohesive force of which is the periphery of the vacuum, could form the energy-free Cosmos or Space. Where there is no artificial sphere there must be a sphere of force, a "force area." (See paragraph 5, p. 52.)

Let us ponder carefully over this; a sphere has a geometrical centre, but a vacuum has none—it is itself a centre, not a geometrical, but a physical centre; but this physical centre is a combustion point of some form due to implosion.

Here we have a core of one component of the ether (hydrogen energy) and the densest material which can exist in the whole Cosmos. This, and its surrounding oxygen stressfield, constitutes the absolute fundamental vacuum in Nature—the required physical centre with its corresponding spherical area of stress stretching for millions of miles. Therefore the sun and its corresponding stress-space or field of stress or stressfield round it, are *two likes in unlike condition*, constituting instantly a Potential Difference.

The sun was formed by compression or densification of the ether on a point of inequality, in other words, a force of suction, and thereby exerts attraction upon the ether

owing to the PD existing between the two; the ether is thus drawn in, catalysed and forced out again as radiant energy. The sun is therefore a suction and force pump, functioning in the primary state of matter—the energy form; two likes in unlike condition is the greatest force which can exist in Nature, but when in the free state as a sun and its surrounding stressfield, *one must move!* The sun moves through the Cosmos, together with its surrounding stressfield, otherwise it could not feed—it must function, as it were, on a constant new stimulation through its stressfield and so the sun compensates for its loss in radiation and retains its size in this manner. Furthermore, it is quite obvious that the sun and its stressfield are one and must move as one because they are complementary.

The point of inequality in the homogeneous ether was established at that instant when the previous sun formed a crust and became an earth. Its motion ceased and its magnetic field (due to the glowing magnetism core) concentrated and produced a point of inequality in the ether; this concentrated stressfield crossing the homogeneous ether stressfield, and being concentrated, it produced polarisation of the ether components—the hydrogen component, as has been explained, concentrating on the point of inequality and forming the new sun's core. It follows, therefore, that the size of the new-born sun depends on the size of the hydrogen concentration, which depends on the intensity of the concentration of the new earth's field, which forms the point of inequality in the ether. The greater the intensity, the greater the concentration of the hydrogen sublimate—the point of inequality being formed at the square of the distance of the earth's diameter in kilometres, not in miles.

A sun is thus the greatest suction force in existence, it is a space without air but densified ether, it is therefore vacuum, or rather the Primary Vacuum. It is the force of cohesion in its original form, between its core and periphery, bound by the potential difference, between the two likes in unlike condition—the glowing and cold conditions of ether; it constitutes the complete atom—kernel and nut exerting attraction through mobile exchange—that is, inter-

polar energy transference due to the PD in spherical form. The sun's periphery convex, together with the spherical and cold surrounding stressfield, concave-spherical—this is the complete atom, this constitutes the atomic force in the origin state, as a mobile potential difference.

The ether is a static potential composed of two components which, when polarised, form a force of attraction; magnetism is described as "the force of attraction," thus the ether is magnetism in the latent state or latent magnetism; when polarised, the hydrogen component is magnetism in the glowing state, or glowing magnetism. This is the Fundamental Force, the Cosmic Force, Space Force, the real Atomic Force in the free state as a potential difference, in fact, the Primary Force. The artificial production of glowing magnetism, and its technique, whereby it can be produced and applied to mechanical power, indeed to every present requirement of human activity and more, was the essence and purpose of this discovery.

The sun is thus a negative fire, functioning by compression without air; whereas a positive fire functions *with* air, expansively. Both must have the basic ingredients of a fuel, viz. carbon, hydrogen and oxygen; the sun, as has been shown, possesses these in the primary state or energy form.

Diesel fuel has this also in the energy form, but clothed in the vapour state, and fire is obtained entirely by compression.

In contact with air, glowing magnetism would immediately be disintegrated and disappear; out of contact with air, it is the greatest "fuel source" that can exist in Nature. In contact with air, the positive fires thrive as fuels and sources of heat and radiation; out of contact with air, the fuels, as such, disintegrate and split up into their constituent parts, but always, of course, to form the three components of which every fuel, positive or negative, must be composed—carbon, hydrogen and oxygen.

Coal is carbon and petroleum is a series of hydrocarbons.

Out of contact with air, what is termed destructive

distillation produces the paraffin hydrocarbon series, all originating from the carbon static potential polarising and forming a hydrogen core, then a solid crust, and by permutations and combinations and other factors dealt with later, these fuel deposits are formed in various states, solid, liquid and gaseous, but all with carbon, hydrogen and oxygen, together with the impurities of formation.

So vacuum is a stress towards inwards; it is occasioned by the *centripetal action of the ether*. This is a *law* in the PP, perhaps the first law.

The vacuum arising from an evacuated sphere is also occasioned by the centripetal action of the ether within the sphere, as such. When the air is present in the sphere, the ether within the sphere cannot exert this suction force from the spherical periphery wall to the centre; this suction force can only function after the air has been removed. This suction force is due to the ether itself being latent magnetism and thus having the characteristic of suction within it, but which can only function when all the right conditions obtain.

In an artificially formed sphere, after the air has been removed, it exerts a pressure or suction over the entire peripheral wall of the sphere to the geometrical centre. This suction is exerted through the "hold" which the ether has on the cohesive force of the material of the sphere wall, whether this is of glass, steel or any other material. The denser the ether within the sphere, the greater the suction, as the suction arises from the ether itself.

On the other hand, Space is not vacuum unless centripetally formed as an area of force or potential (a cosmos).

Vacuum is really the mother of magnetism.

The ether is vacuum material and is a spherical stress-field; it does constitute a secondary vacuum if its sublimate—air—is removed artificially.

Glowing magnetism is the true vacuum.

In principle *only*, vacuum and magnetism are identical; because magnetism is a bipolar force of attraction, and vacuum in the primary state exerts attraction and suction between the core and its surrounding stressfield, which is primary cohesive force, or the force of cohesion.

Now, it is said that Nature abhors a vacuum, yet she functions with nothing else but vacuum on vacuum, or stressfield on stressfield, for the simple reason that nothing else exists with which she can operate.

Cohesive force in material is vacuum, because vacuum is the origin cause of the cohesive force in the material.

Vacuum is hydrogen and oxygen energy in polar impolarity. That is, the core, with its surrounding stressfield, is polar in form, but impolar, indifferent, or neutral within itself.

An illustration may make this clearer: an electric generator has, say, 4 pairs of poles and is therefore polar in form in relation to each opposing pole, but if we remove the armature, the field in the centre will be impolar, indifferent. In material the oxygen and hydrogen stressfield is indifferent, impolar or equalised out—the pull between these two components is equal and opposite as a homogeneous stressfield which compacted the material, and gave it tensile and compressive strength; this is the Cohesive Force, occasioned by the Vacuum Force. Now polarise this homogeneous stressfield and the material disintegrates and disappears.

So vacuum is a stressfield occasioned by two components which operate inwards, where the form permits—that is, when it is spherical—towards a centre, but always inwards. If vacuum were a stress outwards, it would be steam or vapour.

Vacuum has only stress, it possesses no matter and therefore no electricity. Glowing magnetism is densified vacuum or the fundamental electro-magnetic force functioning as radiation or as a stressfield.

So vacuum has the characteristic of always exerting force inwards.

The whole of Space is the force of cohesion, but in the unbound or free state, until polarisation of the components ensues, then it is true vacuum in form—the sun—but a free potential difference unbound to material.

Space or the texture of Space, the ether, has two definite conditions, the cold and what may be termed the hot or

glowing condition. A sun, for example, is in the glowing condition, but it is only densified ether, it could not be anything else, because there was nothing else available of which it could be composed.

The terms "warm" and "cold" ether on page 53 refer to ether in air and ether within an artificial sphere, from which the air has been exhausted—heat and cold in the primary state being really potential or density. When these reach a critical point, light-matter is formed and we have the glowing state, which is the origin of heat in the secondary states, when the right conditions are present (*e.g.* sun's rays crossing earth's stressfield). Hence the extended use of the terms "heat" and "cold." Furthermore, as we now know, heat and cold in the primary state are the origin of heat and cold in the secondary states.

The Creator's workshop, judged by our standards, with the multifarious substances and machines at our disposal, is really a poor affair. He has, and this is a scientific fact, only two things with which to fashion a Universe with its myriads of heavenly bodies, viz. what we in our language term carbon potential, and Himself. And He Himself is also vacuum; He could not, speaking scientifically, function in any other way; not, as may at first be regarded as the reason, that He Himself made the law of vacuum functioning on vacuum, but for a much more basic and definite cause—the law of vacua on vacua was not made by Him, but arises out of the fundamental origin that He Himself is vacuum, the *Dei Vacuum*. In the cosmos, nothing else could function as "origin" because neither the facilities nor materials are available for anything else, and as this origin must be conscious-physical, it must be the Creator, and everything else must be derived therefrom.

The Primary Force in the cosmos is compressive, exerting suction. Vacuum is termed a suction force, hence the use of the term but qualified here as Primary Vacuum, and it is conscious-physical, having its origin in the functioning of the *Dei Vacuum*, the Creator.

CHAPTER VI

LATENT MAGNETISM

We have seen that the ether or texture of Space is densified vacuum, relatively to the latent infinite space outside the (or a) universe or cosmos, but it is not complete or "mobile vacuum" until polarisation has taken place; remembering always that mobile vacuum does not refer to dynamic motion of translation in the ordinary sense, but to mobile transference or interchange of energy. It is therefore what might be termed "latent vacuum force," that is, the carbon static potential until polarised, and when polarised it is hydrogen and oxygen energy in spherical polar form.

The ether is, thus, latent unpolarised magnetism, and magnetism is the interpolar action between hydrogen and oxygen energy static. So the ether is latent magnetism in the cold-stressed state; which exactly coincides with the other definition that it is carbon static potential. Since it is potential, it is stressed; it is static in that it is the texture of space and texture as such cannot move. Whether the universe or cosmos is translated or rotated as a whole, whether it expands or contracts, the texture of space or ether remains. And finally, it is latent as carbon energy because it has no polarity and cannot therefore function except when its two components are released to form polar mobility.

Ether-Vacuum is therefore incomplete or atonic vacuum, that is, complete as static potential, but partial as active vacuum.

Vacuum-Ether is, on the other hand, bound and controlled vacuum complete, atomic; example: the sun and its surrounding stressfield.

Moreover, the ether is a compression product because if it were an expansive product it could not be "potential,"

the "origin-compression" being always a characteristic of the *Dei Vacuum* or the functioning of the Creator; and this is why all original sources of force in Nature are compressive products.

Take our present fuels, *e.g.* coal, petroleum or any other form: they all function expansively either as gases under a boiler or by explosion in a cylinder, when suitably prepared. Newton's Third Law: action and reaction are equal and opposite, and as the reaction is expansive, the action or origin of the force in fuels or explosives of any form must be compressive.

Again, consider steam and the enormous force which it can exert through expansion. From whence does it derive this force? Steam is simply water in gaseous form, once again H and O in energy combination, but clothed as vapour. The greatest force which steam could exert is indicated by pressure electrolysis, where the bubbles are said to have a formation pressure of about 18,000 atmos.; this is, of course, simply a measure of the cohesive force of water; for water is just *latent* liquid magnetism. Cohesive force is vacuum or compressive force due to the equalising out of two components as a homogeneous stressfield. The origin-force is thus compressive.

So the series is as follows:

- (1) Infinite Space.
- (2) Ether-Vacuum (atonic).
- (3) Vacuum-Ether (atomic).

First, Ether-Space,

then: Space-Ether, which is the physical creator of everything,

or again

Vacuum (Origin-force)

Indifferent or unpolarised latent magnetism (The Ether)

Unpolarised Magnetism (Electricity)

Polarised Magnetism

Latent Magnetism appears in different forms; we are

familiar with all of them, but do not recognise that each is really Latent Magnetism:

In Matter we term it Cohesive Force;
 „ a conductor „ Current;
 „ an electrolytic bath . . . ion;
 „ Free Space „ Atmosphere.

Let it be clearly understood that in the PP the atmosphere is *not* the air, but a stressfield—the earth’s stressfield is the earth’s atmosphere, likewise with every heavenly body.

Magnetism is thus a space force, *i.e.* a condition of the atmosphere.

Present magnetism, that is, polarised magnetism, is “polarity outwards,” forming an N and S pole, which is simply hydrogen and oxygen energy, separated by polarisation through the carbon energy content of the steel. So we have carbon, hydrogen and oxygen as was the case in the cosmos.

Now it has been stated that an atmosphere is a product of a polar impolarity, and that the atmosphere or an atmosphere is a field of stress or a stressfield. This condition can be shown diagrammatically, thus:

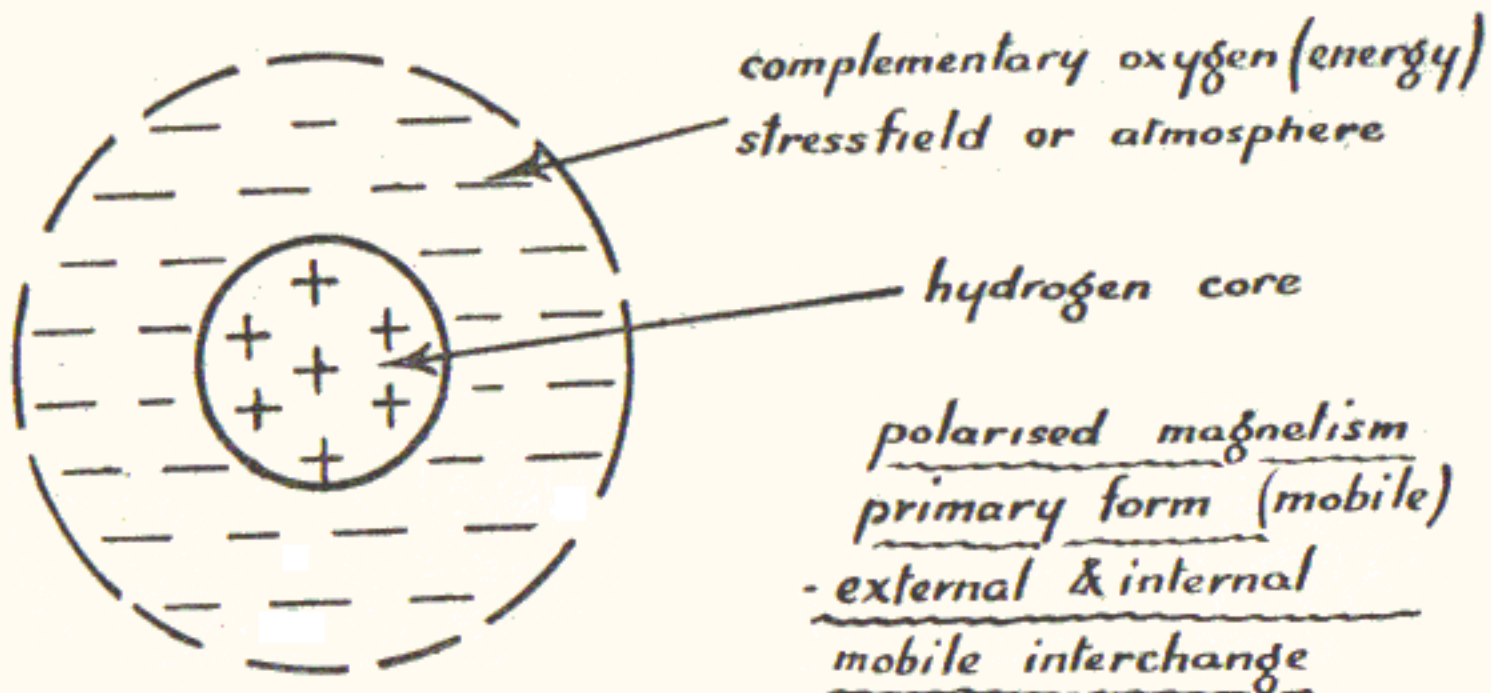

FIG. 1

The air-atmosphere cannot be brought to the glowing state, therefore we need consider only “energy atmosphere.”

This is impolar within itself, but polar in form. It is

LATENT MAGNETISM

the product of a polarised impolarity, that is, the polarisation of the ether; the ether may be shown diagrammatically, thus:

A homogeneous equalised out carbon potential static, the two components of the carbon—oxygen and hydrogen—being neutralised and thus latent.

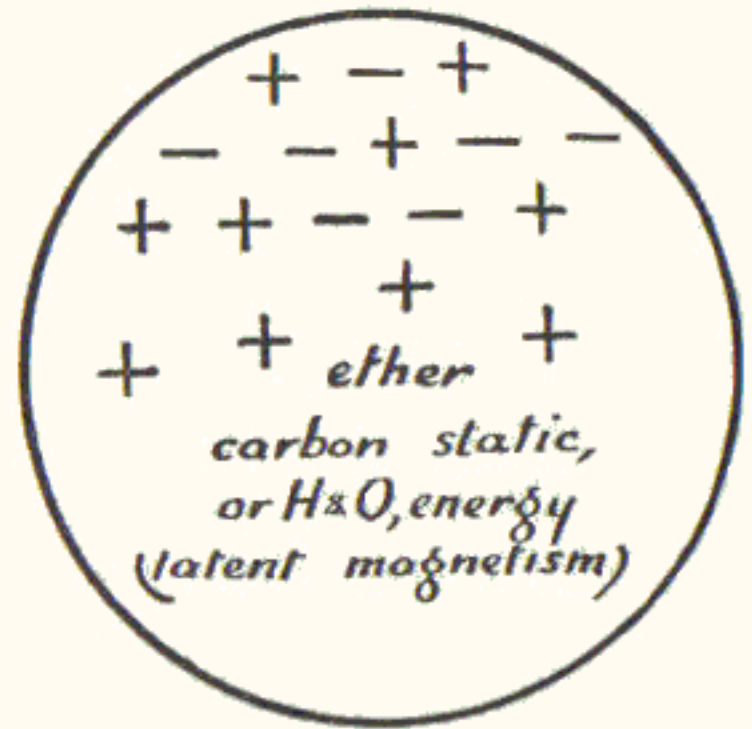

FIG. 2

Diagram 2 represents space as a whole through the cosmos; diagram 1, a portion of space after a point of inequality has caused polarisation—a sun or other variant.

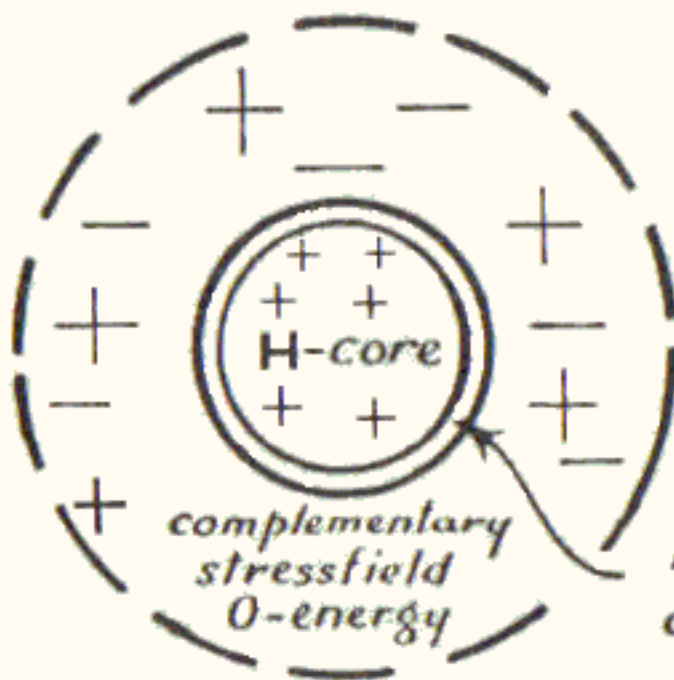

Diagram 3 represents a sun after the crust has been formed; that is when the sun has become an earth.

neutral } internal mobile
crust } interchange only.

polarised magnetism - The Primary Force

FIG. 3

Here we can see the complete magnet just as in a bar magnet, but in the primary or energy state—the two poles (in this case, spherical) and the neutral in the centre. In other words, the hydrogen core, say, the plus pole, opposed by the surrounding stressfield, the negative pole, and between, the neutral, the earth's crust.

It may be asked, then where is the neutral in a sun or other variant, which has no crust, magnetically saturated? The sun is a primary magnet in a condition of mobile exchange, its neutral can therefore only be an energy resistance, viz. the PD. existing on its periphery between the hydrogen glowing core and its cold complementary stressfield. This resistance, as was previously explained, builds the first vapours. (See Chapter on Water.)

The source or origin of the magnetic field is the hydrogen core, but why, it may be asked, is it justified to term this glowing magnetism? Because this hydrogen component of the ether on polarisation has the characteristic of exerting attraction upon itself. Obviously, if magnetism is an "attractive force," in the primary and free condition it must have this characteristic of exerting attraction upon itself, and it is the cause of the centripetal action of the ether on polarisation.

The origin of the earth's magnetic stressfield is compression or densification of the hydrogen component, on polarisation of the ether. The reaction, or radiation in the form of a stressfield, passes through the earth's crust out into the free space beyond. In the earth's crust, this stressfield is bound to material; outside it is free; and between the free and bound stress is the greatest potential difference which can exist in Nature. This PD. exists because of two likes in unlike condition.

We shall see later that this potential difference can be connected up to a suitable catalyst, which will function the fundamental energy cycle, and thereby place at the service of man an inexhaustible supply of energy obtainable as, where, and when required, and controllable as regards quantity and quality—not dead, but biomagnetic energy, because the ether or static potential or latent magnetism is consciously stimulated, as has already been explained, and therefore this Primary Force or Glowing Magnetism is biomagnetic.

Now, what would constitute a suitable catalyst or connection to function this primary energy cycle? Everything must be of "like kind." The PD. consists of bound

magnetism and free magnetism beyond the earth's crust. It is, therefore, all magnetism of quality originating from the central core, which is glowing magnetism. It is thus fairly obvious that the connecting medium and catalyst must be magnetism, and that this magnetism must be in unlike condition, in other words, this magnetism must be glowing magnetism and the new technique will enable this to be generated and controlled.

Magnetic attraction is actually the interpolar pull through mobile energy exchange of the two ether components, H and O energy, acting and opposing through and within one another; this is again in accordance with Newton's Third Law. In the case of the sun, this interpolar transference between the core and periphery and its complementary oxygen stressfield is vacuum force; that is, the force which is the origin of the mobile transference of energy between these two spherical peripheral poles. It is the suction force occasioned by two likes in unlike condition. All magnetic or electrostatic attraction is due to this mobility, *i.e.* energy transference or transpiration.

If it is said that the earth exerts a pull on the sun, or that the sun exerts a pull on the earth, this must be supported by the ether as the texture of space, but how? Through tensile stress? No, the ether is not stressed in that manner.

In the SP we examine stresses in materials for tension, compression, and the combination of these two, shear, and likewise torque. But an energy-membrane cannot be subjected to stress in that way, no elastic limit or ultimate fracture of the ether is possible. That a pull does exist between the sun and the earth is an established fact, because there is constrained relative motion between the two, whether we assume that the earth is constrained to revolution round the sun or *vice versa*.

Science tells us that heat is motion; actually this is a fallacy; heat (so-called) occasions mobility, which is always ready to produce dynamic motion as and when the right conditions obtain, but this does not imply perpetual dynamic motion. However, if heat *is* motion and the sun is said to have an internal temperature of some millions of degrees

Celsius, how is it possible for this stupendously hot body to stand still in cold space and for a relatively cold body to obtain from nowhere the energy and origin necessary for dynamic motion round the sun? The lighter body must revolve round the heavier! But what is weight and which is the lighter? These matters must be dealt with later on, meantime let us return to our examination of the way in which the ether takes the pull or stress between two heavenly bodies.

First of all, what is the nature of the pull? It must exist as tension. What is the nature of tension in the primary or free state, that is, unbound to material? Mobility; energy exchange; transpiration. And what part does the ether play? It is simply the energy frame on or along which this energy exchange can take place and the pull is exerted through this. This frame or energy-membrane is latent magnetism; water is latent magnetism in liquid form, it has no tensile strength, yet it can convey sound and light; but it has an enormous cohesive force due to its equalised out stress of H and O, and the ether has the same as carbon potential, and the conduction of energy exchange does not distort it. This is why the ether is really cohesive force and latent magnetism and why mobile transference does not polarise it, it only supports transpiration and the transpiration is the exertion of mobile stress, not static tension, and this mobile stress does not exert static tension on the ether fabric.

In an evacuated sphere or globe there is vacuum.

Ether in the free, unbound state—magnetism in the latent state—that is latent free magnetism. Therefore ether, latent magnetism, and vacuum are the same, yes, but conditionally so! Ether is potential vacuum; it could not be more than this because it is defined as a static potential, which only, on release through polarisation, becomes true vacuum.

But, nevertheless, there appears on very close observation to be a contradiction here. If a globe is evacuated, that is, the air is removed, it has been previously stated that there is an inrush of ether until the ether density outside and inside

is equalised out. But it has also been stated that ether pervades all space and therefore everything. In that case, the ether must have "pervaded" the sphere or globe even before the air had been removed. Exactly so, but it must not be overlooked that the air being a gaseous sublimate out of the earth's stressfield, that is, the ether stressfield, itself is really built and exists only on the ether and is carried by the ether stress. Therefore, when the air is exhausted, part of the ether is removed with it and the density of the ether outside the evacuated sphere is greater than that inside it.

An evacuated sphere or globe is thus ether-vacuum (atonic). Densify this ether to the critical point, and we then have light-matter formed, not through temperature, but densification, compression, and this is now vacuum-ether (atomic), the atom in its complete and living form, but not organic life; not life, but the living force out of the conscious ether. The sun is a sublimate out of the ether, no longer latent, but polarised magnetism in the glowing state—glowing magnetism.

The whole of Nature functions with this unpolarised magnetism, which in the materials we term cohesive force. Here it is always specific to the material in a substance.

Magnetism, as we use it to-day, is an expansive force with a compressive action, *i.e.* it exerts attraction on matter. (See later.)

Primary magnetism, glowing magnetism, which forms the core of all heavenly bodies, is a compressive force with an expansive action, as has already been explained.

The attraction which masses are said to exert on one another is a "conditional attraction" and is dealt with at a later stage.

CHAPTER VII

SPACE AND ITS FUNCTIONING

Space has thus the compressive force within itself, which functions actively only on polarisation. When polarised and compressed we obtain electricity or the electromagnetic static force. In space itself it is in the form of a sun, which can be reproduced in a suitably designed Stator. In this, the atmospheres are truly polarised.

This is the chemical affinity of matter or space, that is, the texture of space in another form or condition.

Here in space itself is the origin cause of Compression Force, which is itself the origin of all forces, and this is the answer to the fallacies which exist to-day—that light or electricity is fundamental. The origin force is the force of compression which exists as the fundamental characteristic of the ether, and the ether is virtually “latent magnetism,” a compressive force which functions expansively (by radiation as a stressfield). In the latent state as ether it has this compression as a characteristic within it which functions only on polarisation.

Then comes primary heat, then primary light, manifesting itself in form as primary vacuum.

Vacuum occasions spherical interpolar mobility.

This is the true “nature of the physical world”:

VACUUM	{	Ether
		Fluidum
	{	Matter
		Material

Magnetism as in use to-day has too little matter and too much static energy to be termed fluidum.

SPACE AND ITS FUNCTIONING

First the ether, then the concentration of the hydrogen component as fluidum, then densification of this fluidum into mass (as energy), finally reaching the critical point and changing to the glowing state, then forming matter (as energy) or energy material, and later organic material is formed and compacted as crust, the whole constituting a sublimate arising out of vacuum force—the force which has the characteristic of compression in it, which compressive force is thus imparted as cohesive force to *all material* and compacts it as a crust and maintains its form hereafter. This is the origin of atomic force in material.

The first symbol may perhaps be introduced here:

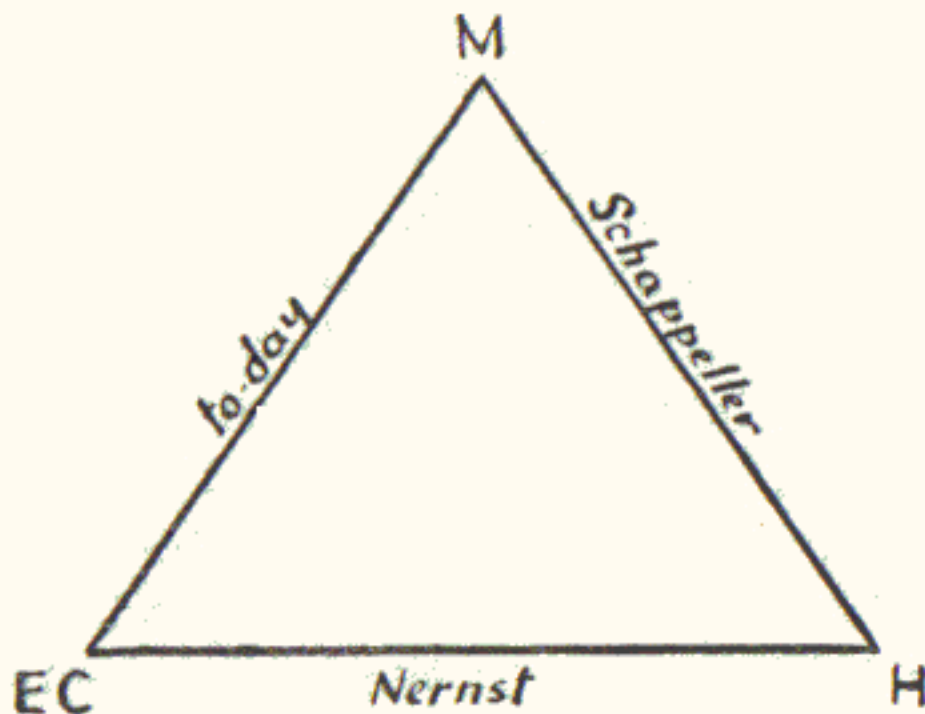

FIG. 4

H—heat
EC—electric current
M—magnetism

Heat one end of a plate of suitable substance, say, bismuth or tellurium, etc., in a magnetic field and a transverse thermo-magnetic current of electricity is produced. This is known as the "Nernst effect." This connects the base of the triangle, heat and electric current.

Magnetism and electricity are the basis of all electrical generators and motors of to-day—one side of the triangle.

The third side is marked magnetism and heat—this is the Schappeller discovery—glowing magnetism.

To recapitulate: we gave as the first law in the PP “the centripetal action of the ether,” as the second, “two likes in unlike condition, one must move.” And now, as the third, that “Nature functions vacuum on vacuum or stress-field on stressfield—the crossing of the energies”—and that this is the only method Nature has of producing any form of force or energy, or transformation of same to another condition.

The first law builds a sun, the second makes it move, the third constrains its path to tangential movement round the former sun which has now become an earth, and is responsible, as above stated, for all transformations of energy into other conditions, such as the propagation of light and heat on this earth.

The PP is, of course, entirely indifferent as to whether present astronomy uses as its basis the so-called Ptolemaic or the Copernican system. Both of these early investigators only used these principles as a basis upon which to work out a system of the relative motions between heavenly bodies. Both systems had their respective merits. The Copernican system, or at least the assumption that the earth revolves round the sun, is the basis of all present astronomical calculations.

The Ptolemaic system, or the assumption that the sun revolves round the earth, must also have had its merits, otherwise Professor Sir James Jeans would not have made the following statement on page 31 of his book (*The Universe Around Us*) that:

“The old Ptolemaic contention that the earth formed the fixed centre of the Universe might almost have regained its former position, had it not been that various lines of evidence had begun to show that even the nearest stars were necessarily very distant, indeed, that their apparent want of motion need cause no surprise.”

Again, the rotary motion attributed to the earth and the planets has not been definitely established. Indeed, from

the statements of the leading astronomers themselves, it is perfectly clear that nothing has been basically established, and that the system adopted in astronomy has been derived more or less from trial and error.

It has been suggested that the sun was formed from whirling masses of gases which gave it its original rotation about its own axis and, likewise, that the planets were formed out of part of this original whirling gas mass. Apart from the difficulties which arise from this theory, as astronomers themselves point out, apparently there has not been the slightest attempt to explain from whence these whirling gas masses came! Gas is not the original state of matter, but energy—and this is now generally accepted by Science, although there is really no alternative.

Astronomers also speak freely of condensation, but make no attempt to explain where moisture first originated.

The fact that a modification of the Copernican system, perhaps assisted by Einstein's Theory of Relativity, explains, or appears to explain, all or nearly all the problems of heavenly bodies, does not prove in the least that the Copernican system is established.

There is still the basic question of cosmogony, or generation of the Universe, on which astronomy at present has nothing but wild speculation to offer, and concerning which the PP establishes at least a measure of law and order.

The co-incidences in astronomical calculations, however remarkable, may still prove to have an entirely different origin and the whole universe of stars may be quite different from the mental picture presented to us at present, which is based mainly on a supposition of relative motion between heavenly bodies, without in any way establishing either the origin or cause of such motions or the origin of the bodies themselves. These suppositions are then tied down by mathematics, but are far from proven.

At first sight it may appear that the PP supports the Ptolemaic system. Let it therefore be clearly understood that the PP supports *no* system, it derives everything from origin. It does not accept or even approve the planetariums

of either the Copernican or the Ptolemaic systems. The PP planetarium is derived from origin on the principle of first establishing Cause, then explaining effect.

The fact that the earth's rotation would solve many of the astrophysicists' problems is no criterion or proof whatever.

Starting with a sun, our present sun, the astrophysicists tell us that there is evidence that the sun rotates on its axis. The PP would account for this rotation as follows: It has been explained why the sun must have motion of translation and thus tangential motion relatively to the earth. The sun's stressfield crossing the earth's stressfield would thus produce rotation of the sun on its axis. The crossing of two stressfields in an electric motor produces motion. In the pure energy state it is not so easy to grasp this. But the electric motor consists only of two energy fields, Stator and Rotor. This actual principle can be applied to produce motion in a newly designed Stator and Rotor adapted to the primary force—glowing magnetism.

But in that moment when the sun forms a crust its motion must cease, its fundamental cycle can then only operate internally, that is, to support the earth in the cosmos; to produce continuously its sublimates, water and air, and to vitalise the earth's crust, producing seasonal growth, etc. But it cannot, owing to the crust, feed on the surrounding stressfield and therefore its motion, as a sun, ceases.

But something does rotate. When the sun revolves round our earth, it is locked "energetically" with the earth's core of glowing magnetism and thus carries this round with it once in twenty-four hours.

But even here the core does not rotate as such, only the resultant stimulation, rather as in the rotating magnetic field of an induction motor. In other words, *the Dynamic of the Cosmos rotates magnetic fields throughout the cosmos*. If any crusts of heavenly bodies *do* rotate, the origin of their motion must be further examined and the cause found before their actual motion is established. The establishment of rotation in heavenly bodies merely in order to explain relative

motion is, of course, entirely insufficient; the generation of the motion must be clearly defined.

All the magnetic fields in the cosmos are rotated as “rotary stimulation.”

There is in the whole cosmos only action and reaction between the cores of heavenly bodies; there is no interaction between the crusts of heavenly bodies. The central cores of all heavenly bodies are glowing magnetism, each is the source of a magnetic field and the whole is interaction on other similar sources of magnetic fields in three distinct forms:

- (1) Through revolution of one body round the other, producing rotary stimulation of the stationary body's core, *e.g.* sun and earth.
- (2) Mobile attraction, *e.g.* two heavenly bodies approach one another according to mobile interaction. This may be termed “negative gravitation,” from one standpoint. Expressed in the SP by the formula $K \frac{m_1 \times m_2}{r^2}$ and given in this sense the negative sign, which of course has no importance in the actual calculation.
- (3) The crossing of the two stressfields, say, sun and earth, resulting in the production of secondary light and heat.

Light and heat do not emanate directly from the sun as light and heat. Primary physical light (light-matter) is formed through enormous compression. Primary light—utter fundamental light—is the Creator Himself; because “origin light” is consciousness—the faculty of seeing in the primary state is spiritual or conscious, in the secondary states it is conscious-physical. This is not philosophy nor religion, but the Primary Physics. Primary physical light is light-matter—possibly the photon of secondary physics—but this photon, when formed, is not directly visible to the human eye; even then there must be the crossing of the stressfields.

In the case of the sun's light, this crossing of the stress-fields, *i.e.* the sun's and the earth's stressfields, generates light and heat on the earth's periphery. It is then in a state to be visible, but it must be crossed even then with another stressfield before the animal kingdom can perceive it or the vegetable kingdom can react to it. Every living organism, animal or vegetable, has its own stressfield. This is inherent, since it is a biomagnetic entity. The light-matter crossing our individual stressfields enables us to see. (See Part III, Supplement, page 311.)

Now, what actual evidence is there that the Creator *is* the fundamental source of light? Seeing is not a physical matter, although light is required to function the organ of sight. "Seeing" is a conscious faculty. If we are unconscious, although our eyes may be open, we cannot see. The All-Pervading Consciousness is therefore Primary Light itself, and we term this here the Creator. The physical component of light is a derivative, but must be blended with the conscious component before it can function. Furthermore, there is absolute proof that many people have the power to see and describe those they see in very great detail and with absolute certainty without the use of their eyes at all, and without ever having seen the people they describe. This is, of course, a pure energy action, but it is not the time or place here to explain it.

Light is always a compression product, even in the SP, as we shall see later.

It has been previously stated that nothing fundamental can be produced or transformed without first the crossing of the two stressfields; the fundamental case is, of course, the formation of another sun. The sun, when becoming an earth (as has already been explained), ceases its motion and its stressfield is concentrated on a point in space—the crossing of the sun's stressfield with the stressfield of the homogeneous ether. But in this case, the one is a stressfield concentrated on a point, thus producing polarisation of the ether. Nature functions, and can only function, by this means. We may now make the statement more definite still and say that nothing fundamental is produced or trans-

formed without the crossing of stressfields. Let us carefully analyse this statement in the light of actual facts:

- (1) The formation of a sun due to crossing of stressfields as above explained.
- (2) The sun, as has been explained, maintains its energy due to the crossing of two stressfields—it acts practically as a suction and force pump in the energy form.
- (3) Light and heat are produced by the crossing of the sun's and earth's stressfields.
- (4) Nernst, Ettinghaus, Hall and Leduc "effects" are all produced by the crossing of stressfields—a heat stress crossing a magnetic field produces electricity; or an electric current crossing a magnetic field produces heat. Likewise with the Thompson and Peltier effects, the technical apparatus being different as it is here adapted to the measurement of temperatures.
- (5) The production of steam is effected by heat stress crossing the cohesive force of the water.
- (6) The Zeeman and Stark effects, where light emission in a magnetic or electric field causes change of wave-length and polarisation, are due again to the crossing of stressfields, although in a "space without air," a secondary vacuum, no such alteration to the emitted light ensues. This is probably due to the concentric radial ether stress.
- (7) In atomic chemistry the ionisation produced by a moving particle is due to the interaction of its electric field with the electric field of the atom traversed. This is once again brought about by the crossing of the two stressfields—the *Third Law in the PP*.

Take the production of a neutron by a natural emanation:



Here the field of the alpha particle crosses the field of a Be atom producing a neutron.

Or again, an artificial transmutation produced by swift protons:

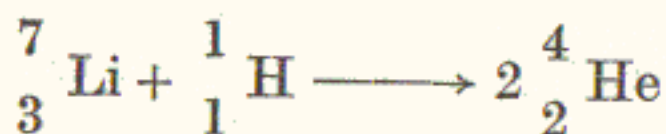

Here the field of a proton crosses the field of a lithium isotope producing two alpha particles; or the production of beryllium:

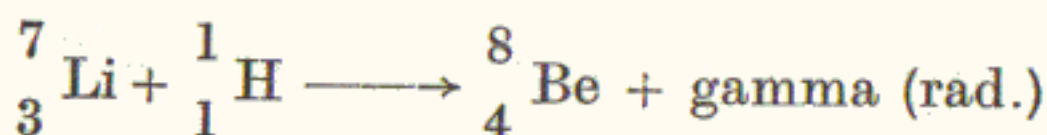

Here the field of a proton crosses the field of a lithium atom, the surplus being, not heat, but gamma radiation.

Just as mobile interaction in the sun produces not heat, but radiation as a stressfield.

It does not, of course, follow that in the SP the right conditions will always be present to produce, transform or otherwise change an energy owing to the crossing of two stressfields. *The law is, that no such change can be brought about without the crossing of two stressfields.*

CHAPTER VIII

ORIGIN-MATTER AND ITS FUNCTIONING

The term "original matter" seems more correct, but it would give the impression rather of the past and not of the present.

Origin-matter is still, as was explained in the definitions, Carbon Potential. This is the elemental from which everything is derived by polarisations, permutations and combinations.

The new atomic chemistry has clearly proved through the transmutation of substances that the elements are not indivisible, and therefore that they do not exist as such.

The origin is thus an "elemental"—something capable of functioning the Ether by polarisation of its two components. An element by its very definition could not function and there could only be one, otherwise it is derivative, and then it could not be an element. And being an element nothing could be formed from it because it could not function. So an element is something which was derived from nothing and could form nothing, so nothing exists—*reductio ad absurdum*.

The element is carbon static potential, a sublimate out of extra-cosmic space, *i.e.* infinite space, the storehouse of latent unstimulated energy static beyond this cosmos, and beyond and around others. It is from this source or storehouse that Jeans's infiltration of radiant energy (see next page) must be poured in, but not into empty space, because there could be no such thing. The process is quite different from that. It is not "poured into itself." It was specifically "formed" into a sphere of stress, a cosmos or universe, by the consciousness or thought-force of the Creator transforming the previously unstimulated static ether into a

stimulated conscious-physical spherical Space-form, which we call a cosmos or universe, but now possessing potential owing to its Space-form stimulation to the centre of stimulation or "inequality" on which it was formed.

The origin is thus an "elemental," and even this carbon potential is a sublimate out of extra-cosmic space, *i.e.* infinite space, the storehouse of latent unstimulated energy-static beyond and round a cosmos—carbon potential static, impolar, and really the ideal latent vacuum state, immobile vacuum, which means no energy transference within itself—a static condition of energy possessing Space-form.

So this carbon energy static is the primary *physical* creative substance or the primary source from which physical creation can commence, but, of course, blended with consciousness, because it is, as we have seen, creative and therefore conscious when the right conditions obtain—polarisation, producing conscious-physical mobile exchange, as has been explained.

Hydrogen is a sublimate out of carbon energy. It may be asked why is not oxygen also, since carbon potential has two components, H and O, and is in fact H and O energy as a homogeneous static stress.

Nevertheless, one could hardly term the other component, oxygen, a sublimate, as even after polarisation it remains as a "distension" or stressfield, surrounding the precipitate, hydrogen, and thus preserving it as a core.

Carbon energy static is virtually the cosmos itself and has the highest potential possible in Nature. This is why on polarisation we obtain the highest potential difference in Nature, *viz.* between the hydrogen core and the surrounding oxygen stressfield.

Sir James Jeans (page 327, *The Universe Around Us*) suggests that we might picture radiant energy of any wavelength less than 1.3×10^{-13} cm. being poured into empty space; this being energy of higher "availability" than any known in the present universe.

He suggests that the running down of such energy might create a universe like ours. Also that this energy

might crystallise into electrons and protons and finally form atoms—with the finger of God agitating the ether. But he then suggests that we may avoid this “crude imagery” by insisting on space, time and matter being treated together and inseparably as one system.

On page 318, he says that we must learn to think of energy, not only in terms of quantity, but also in terms of quality. Its total quantity remains always the same (first law, thermodynamics), but its quality varies and tends always in the same direction.

Sir James means by this, that the energy changes to a longer wave-length.

Now let us analyse this carefully.

Apparently scientists cannot get beyond a laboratory idea of creation. In other words, the substances are there and God, the chemist, mixes them. So mathematics is called to our aid to create a universe out of space, time and matter, but without informing us where space, time and matter came from or in fact what they actually are and furthermore what “time” signifies.

Again, that potential difference of a certain wave-length is “poured” in, apparently from extra-cosmic space—it must come from somewhere—so that in “running down” it may produce a universe, which instantly brings us to the question: where did potential come from in the first instance? Who wound up the clock?

Obviously, the Creator is the Conscious Potential itself, the origin of time, space and matter. Time is derived from the all-conscious frequency—in the PP the *Dei Vacuum*, transpiration, producing periodicity, period, and finally time as we understand it. (See Chapter on Entropy.)

Space is the extent of this Consciousness, which is infinite. Matter is the first physical sublimate out of this Consciousness.

Consciousness never began nor was it created—it is the Creator Himself.

Alteration in wave-length is not alteration of quality, but of condition of energy.

Science at present cannot produce quality of energy.

Electricity, magnetism, steam, have characteristics which demand a certain technique, but no individual quality. We cannot produce different qualities of any of these forces.

In order to produce different qualities of electricity, we must be able to produce different qualities of magnetic fields. This can only be done by the PP, because the magnetic field utilised and produced here can be of any desired quality and is entirely different from the gauss field of the present day.

So life is not a haphazardry in the scheme of things, because the Creator Himself is origin life.

Organic life is mortal and finite and possible in the universe only under rare circumstances, but life-energy and life-entity are immortal and infinite and without these there could be no organic life.

This digression is legitimate in dealing with origin-matter and its functioning, because the origin of origin-matter is conscious-physical.

So to recapitulate: Carbon energy is the primary matter from which physical creation can evolve, and this is actually permeated with conscious frequency, which gives it "creative potential" and makes it capable of primary polarisation, which is, of course, a conscious action or functioning, H and O being really specific conditions of carbon potential, the release of which lies in the Dynamic of Nature.

Hydrogen is a product of heat stress; oxygen is a product of cold stress. Both cold and heat are stresses and every form of matter exerts an attraction or suction on heat or cold stress.

In the primary state heat stress is actually hydrogen and cold stress oxygen. In material these two stresses equalise out as Cohesive Force.

It will be seen and finally realised and understood that Nature is one unity.

Electricity is simply the product of heat and cold stress, but only under certain specific conditions.

In carbon potential the heat and cold stress are present, but latent.

Every form of stress can be converted into electricity,

if the right conditions can be produced, but heat and cold stress are primary, not electricity.

- 1st. Heat and cold stress (primary)—H and O on polarisation.
- 2nd. Primary biomagnetism—H and O in mobile exchange.
- 3rd. Primary bio-electromagnetism. (Radiation, as stressfields, resulting from (2).)

This is the order in the universe; carbon potential is the primary source from which is derived:

- A. The cold condition;
- B. The warm or glowing condition;

by the process already elaborated.

CHAPTER IX

HEAT AND COLD

These are gravitational forces, that is, forces of induction—penetration of energy into matter.

In solid bodies, cold draws them together (compressive).

In free energies it operates the opposite way, cold produces or is distension or expansion and heat functions compressively.

A locomotive cannot be driven directly with a fire or heat energy, a resistance is also required. The cohesive force of the water supplies the resistance and compresses the heat stress from which the enormous expansive power of steam is derived (Newton's Third Law and the law in the PP of the crossing of the energies).

Schappeller, as we shall see later, does not require water as a resistance; he uses fire or water (it is really the same thing in another condition, *but of course applied through an entirely new technique*).

Heat may be regarded as plus

Cold may be regarded as minus

energy. Primary heat, as may now be understood, is composed of cold energy. Positive fire is really unipolar, therefore it is held together not through the surrounding pressure, as is the case with the negative or primary fire (glowing magnetism), but through the centripetal action of the glowing atmosphere within the flame, exerting attraction upon itself, but not of course with the same enormous force of attraction as is generated when it is pure hydrogen energy out of contact with air.

The sun is held together through the impolarity towards outwards. This sounds obscure, but it simply means that

the sun is being as it were pulled through itself from all sides, or better expressed, over its total periphery, by the atmospheric or ether suction through it and thus held together tightly as a core.

We shall see later how the sun is being constantly "wound up"; what causes it to suck in, catalyse, and radiate out, in other words, what the sun's mainspring is, but this belongs to the Chapter on Entropy.

In the cosmos, cold is expansive, and constitutes a distension, but functions compressively. In Nature, primary or negative fire is really a released heat and cold stress.

Cold is not, therefore, just absence of heat, primary heat and cold having nothing to do with molecular action. There are no molecules available.

Secondary heat, positive expansive heat, manifests itself in molecular activity. Primary heat (compressive) is not measurable in temperature as such; the temperature degrees attributed to the sun and stars are really measures of their densities. Furthermore, heat and cold function, as we have seen, quite differently in the cosmos or primary state from heat and cold in the secondary states of matter. In the cosmos, the heat component precipitates as a sublimate (compressively) and the cold remains as a surrounding stressfield or distension. Whereas, in the secondary state, heat normally produces expansion and cold contraction. There is an exception, however, due to the fact that heat and cold, here, produce also change of state. The greatest density of water is not at zero, but at 4° C.

Science has long since discovered this fact, but not perhaps the full significance of it. The theory in the SP is a very simple one: that as the temperature is increased the molecular cohesion becomes less and less until a solid body melts and takes on the liquid and finally the gaseous state, density being a measure, as it were, of the degree of molecular cohesion. Therefore if we raise the temperature from 0° C. the density should decrease, but it does not—on the contrary, it increases up to 4° C. and then decreases—and likewise decreases with supercooling, so that the apex of the curve is 4° C.

The proportion of D* to oxygen is so small that it could hardly be attributed to a redistribution of this; the explanation is unlikely to be found in the SP. Where the problem is wrapped deeply in the secondary states of matter, it is not always possible to give the solution immediately, even if the ultimate solution lies in the PP. But it is possible that for this complex and basic compound known to the SP as water, the frontier between the heat and cold stress is found on our present measure of temperature to be 4° C., which even in the SP supports the fact that cold is not just absence of heat, but the complementary stress. This, however, is dealt with later under the Chapter entitled "Water."

* Deuterium.

CHAPTER X

ELECTRONS, IONS AND SUBLIMATES

An *Electron* is really a specifically charged sphere of H and O energy, according to the conditions under which it was formed.

An electron exists only through some form of catalysation, and this also applies to the atom. Sometimes we call it electron, sometimes atom. In a wire it is an electron, in glowing magnetism it is an atom. But an electron is not an atom because the creative force is missing.

An electron is a static force in dynamic condition. In the SP an electric current in a wire is a stream of electrons. The electrons as such are static, but they are moved, as we shall see in the Chapter on the Electric Current. An electron is a minute unit of mass (as energy), a unit of energy, it is Millikan's e in the SP.

It is a specific form of vacuum. Since a stream of electrons can pass through a solid body such as a wire, they must themselves be vacuum or vacuum force. (See Chapter on Electric Current.) The PP does not really require the term electron as it is a product of the secondary states.

Ions are fluid electrically-charged units of mass (as matter), possessing the same cohesive force as the respective metal from which they came, and of course the same latent entity or characteristic.

Electrolysis is really magnetic distillation. The ion must be a product of its own origin; this is the cohesive or atomic force of the plate or electrode, together with the characteristic of the particular materials, *e.g.* copper, aluminium, etc.

The entity of such materials in the ion is devitalised and exists only as characteristic because the atomic or

cohesive force of the material, plate or electrode, is not in mobile condition, cohesive force in material being static or sterile, but functioning as tensile, compressive or shear stress.

A *Sublimate* is a condensate out of something. It may manifest itself in the solid form as a substance or precipitate, in the liquid form as an ion, or in the gaseous state as a gas, and also in the energy form as an energy sublimate; a basic energy sublimate being the glowing core of the sun.

CHAPTER XI

STATES OF MATTER

There are five states of matter, although the Author prefers to classify them into four, the first having two conditions.

PRIMARY STATE.

- (a) Space in the cold state.
- (b) Space in the warm state.
- or (a) The ether as static potential.
- (b) The ether concentrated as densified glowing hydrogen core.

SECONDARY STATES.

- (1) Gaseous.
- (2) Liquid.
- (3) Solid.

In one sense only, the real natural elements are fire, water, earth and air, all of which are successive sublimates out of the primary and only "elemental," carbon static potential, that is the Ether of Space.

Matter can only be built within a potential difference whether it is matter as energy-material, as gaseous, liquid or solid material.

A PD. is essential, it is the origin of the cohesive or atomic force which binds all forms of matter; it is the origin of the cohesive or atomic force in all forms of material.

The atomic force of present Science could not exist if it did not originate from a fundamental Potential Difference. That is why the so-called "splitting of the atom" is from one standpoint an unnecessary and dangerous system of

deriving benefit from the atomic force. Transmutation of substances by this means is a clumsy method. The atomic force is derived from the Potential Difference earth-atmosphere (earth's stressfield); link this up and the atomic force is available and can be collected, manipulated and controlled—it is, of course, glowing magnetism. Furthermore, transmutation is unnecessary, as whatever substance is required can be produced direct by transpiration.

But to recapitulate, matter (as material) can only be built up between a Potential Difference—through mobile transference between two poles, the one being warmth or heat, the other cold, of course in the Primary State. This mobility or energy transference between poles is, it will be remembered, the system or method by which primary magnetism functions, *e.g.* the sun and its peripheral and complementary stressfield.

It is the equalisation of heat and cold stress that produces the force of cohesion, the atomic force in material—magnetism in latent or impolar bound form. Because, as we have seen, primary cold and heat as a homogeneous static stress is the static potential or latent magnetism. When polarised, as in the sun, it is heat and cold stress in polar form, *i.e.* a potential difference.

Heat thus maintains a given state of matter; nevertheless, it lifts the weight which is taken by the cold pole. The sun, for example, is maintained by heat potential (primary), but it is supported in the cosmos by the energy or etheric pressure which this heat potential exerts on the surrounding ether as stress. In other words, the surrounding stressfield carries the sun's weight.

The series in all its refinement may be expressed as follows:

- | | |
|------------|--------------|
| (1) Energy | (3) Matter |
| (2) Mass | (4) Material |

with the aid of heat.

Energy is a sublimate out of force. Force and energy are a cycle, each as it were being a sublimate out of the other. Force is potential energy, energy is potential force.

In the SP force and energy are defined not by what they are, but by what they do. Force is that which tends to change the state of motion in mass. Energy is the capacity for "doing work." These and all other definitions arising out of them, *e.g.* momentum, work, power, inertia, etc., are all mathematically expressed in formulæ, derived from one another, which form the basis of statics and dynamics. The SP shows how force and energy function in the secondary states of matter, and the PP shows their functioning in the primary state, which in many cases explains the cause and origin of their functioning in the secondary states. But all this still leaves us with the puzzling problem, what is energy and what is force?

Energy static is the primary creative material—consciousness at first in the static form, but not life in any sense of the word. In this state it can function only as a static membrane or carrier. It has no dynamic until polarised.

Energy dynamic is the release of force, force in another condition, that is, densified and mobile energy.

Energy static or force is really the conscious material of Nature, by which and through which everything is evolved, but in the static state the consciousness is latent within itself, potential consciousness being released only on polarisation.

First Might or Potential or Force, then Potential Difference, then Force, then the release of Force, that is, Energy, into one of the various forms, heat and cold, light, magnetism, electricity.

Energy is, in principle, the product of a potential difference. Force is that which is derived therefrom and is in various forms.

Energy can do nothing by itself. It can only work on or in mass or material. Material dominates, not energy. Even in the primary condition this statement is true.

Static energy must first densify to mass (energy-material), then to matter, before there can be Dynamic or mobility, *e.g.* the sun's core.

Goethe said: *Energien die sinnlos walten können kein*

Gebild gestalten. (Energies which aimlessly roam cannot possibly build a form.)

Energy is actually static within itself, but dynamic as a whole. This is important when we come to study the electric current.

Mass is force in the bound state. It may be regarded as densified energy before implosion.

Matter is energy-material with form, *e.g.* in Space a sun. In the air, it is "lightning material" before the discharge, which latter is merely an equalisation of potential. The lightning itself is the potential matter—not static but dynamic potential—dynamic in the sense of mobility not of motion, but instantly dissolved owing to contact with air because no complementary pole or stressfield exists. It is therefore a hydrogen core, glowing magnetism, formed and instantly dissolved by equalisation of potential and this is the flash.

Material. Mass and Matter are entirely energy-materials, but material has only an energy frame, the equalised out stressfield of H and O, or heat and cold, or latent magnetism in a potential difference, but even then an entity is also required—thus the definition of material in the PP, that is, organic material, as *a growth between a potential difference.*

All material is organic in origin. The organic mobility or polarity here are the two fundamental poles, Life and Death. This, of course, applies to so-called "dead" material, that is devitalised material. The sequence in the case of organisms or living materials is treated specially later.

Everything that exists in an earth's crust is of organic origin, formed by the poles, Life and Death, between a Potential Difference through mobile exchange and vacuum compacting. This will be clearer when we examine later the origin and sequence of the formation of the earth's crust.

Magnetism is potential or force without matter.

Origin-Magnetism is actually the origin life-matter, in fact the first physical sublimate of the Creator—the Ether.

Life is not a state of matter, it is a condition of the energies with form, but this is explained later.

CHAPTER XII

THE ORIGIN-MATTER

The true origin-matter is Life. It may be contended that it has just been expressly stated that Life is not a state of matter. Both these statements are correct, although at first sight seemingly contradictory.

Origin-matter is not a state, but a condition—a condition in the energy form. Pure energy static is not necessarily Life. The ether is not Life, but the condition of the ether as primary or origin-matter (physical) is consciousness.

One could not speak of solids, life, liquids, etc. The state of Life is always in the energy form or primary state, but the point is that the primary state is not Life. Life is neither solid, liquid nor gaseous, nor the energy form; it is consciousness, and consciousness is not matter as state, but matter as origin.

The fundamental origin of origin-matter is, of course, the Creator, and He is Consciousness, His condition is energy, His functioning is potential, His force is vacuum. He has not *made* "the laws of Nature" and thereby the Dynamic of the Universe. He *is* the Dynamic. His functioning *is* the laws, which we are permitted to discern within the limits vouchsafed to us.

Now if origin-matter were protons, electrons and neutrons, then the Creator must likewise be a product of these sterile constituents. He is then certainly not a Creator but a robot. The only Creator possible is consciousness. So origin-matter is conscious and origin-energy is origin-matter and is therefore also conscious, because origin, as such, is conscious-physical. The words energy and matter here are therefore superfluous, if not actually meaningless

restrictions; the only word available which is universal and complete, yet unconfined, is "creator." Every word in our human language must have its definition, words thus isolate and insulate meanings through the restrictions they impose. The words energy, matter and the like are therefore only permissible for origin-derivatives, and this is why no word can express "absolute meaning," since a derivative is itself not absolute, but relative or referable to origin.

Derivatives of this origin-matter or consciousness are termed Life. These are a condition of the energies with form, and when clothed in the solid state we term it organic life. And organic life is maintained by the forces existing in our "conditional elements," viz. earth, air and water, all of which originated from fire (glowing magnetism).

Organic life is really the centripetal action of these forces, that is in its first form as life-force, or centripetally formed biomagnetism.

There are many who say that they will under no conditions accept a God or a Creator as such, and that for them Nature and that alone is the Creator.

This amusing contradiction is an expedient used to relieve man of all responsibility for his actions.

An abstract Creator cannot judge him, cannot demand from man any service. But a Creator is Consciousness. Nature is conscious or consciousness, otherwise we who, speaking abstractly, are products of Nature, if there are those who prefer the term, could not be endowed with the faculty of consciousness. Therefore the functioning of Nature or the Dynamic of the Universe is the Creator, and the Creator must be the Ruler of His own Creation. Whether, therefore, we prefer to term this "Dynamic of the Universe" Nature or God, it is nevertheless the Creator, the All-Pervading Consciousness. This is where real Science, the real Physics, begins, and that is why it is termed the Primary Physics, the all-important point being that the Primary Force, of which all other forces known and used by us at present are derivatives, is conscious-physical—this is the blind spot of science and the key to all "origin research."

The physical is a derivative out of the spiritual consciousness, the essence out of the Creator, and thus the Ether itself is conscious static potential. In other words, the conscious and the so-called physical are blended, although in the secondary states of matter consciousness is dormant, devitalised or latent. It is, therefore, important to emphasise that the Primary Force is a conscious force, otherwise certain of the phenomena in the Primary Physics would not be understood. The Primary Force nevertheless produces the secondary forces, but these are then in a devitalised state, *e.g.* electricity and magnetism, devitalised through the apparatus employed.

What may be termed the physical sequence here is:

Space as such.



Synthesis of Space is Carbon Energy (Ether).

The polarisation of this releases Heat and Cold stress.

Heat stress contains the Life force (biomagnetism)
and Cold stress prepares it.

It is, therefore, quite incorrect to designate Life as “a state of matter”; it is what it originated from, that is, consciousness and the corresponding energy adhering thereto—it is thus a condition of the energies with form.

This subject is dealt with cursorily in Part III: basically, it is beyond the scope of this book.

CHAPTER XIII

THE FOUR CONDITIONAL ELEMENTS

Fire, Water, Earth and Air—these are really the four conditional elements, the physical ingredients or nature of the physical world. They are not elements in the sense of materials, they are elements in the sense of conditions. They are matter, but they are not material. Their synthesis produces everything which exists.

Let us analyse them carefully one by one. In this Chapter we are dealing chiefly with Fire (negative and positive).

Fire (negative)—Origin-fire.

Water is H and O (magnetism latent), the Ether is H and O, therefore origin-fire is H and O and is the first condition of water. The sun is a spherical core of negative fire, but can exist only in conjunction with its complementary oxygen stressfield. Therefore origin-fire is not merely H but H and O. It is negative because it is formed by implosion, but it functions out of contact with air, because it is formed compressively and functions expansively by radiation. A hydrogen core is a sublimate out of the Ether, and water is a sublimate out of the hydrogen core and its complementary stressfield. Therefore the first condition of water is fire, but it requires its complementary stressfield.

Fire is thus a sublimate, the sublimate is matter, and fire is highly compressed hydrogen-energy matter out of the cosmos or Ether.

Fire builds space-form. The sun, for example, is spherical in form. Everything in the cosmos desires to be spherical, and is spherical unless it is distorted in formation or by external influences. The universality of the spherical form has its origin in the first law of the PP, viz. the centripetal action of the Ether on polarisation.

Fire always forms its complementary stressfield, its opposite pole. Negative or origin-fire is bipolar; positive fire is unipolar, that is why it cannot be compressed, densified.

Compress a positive fire and it explodes.

Fire is a suction mechanism and this is the main characteristic of fire.

Fire is matter but requires its complementary stressfield as the opposite pole.

Fire thus produces space-form and the opposite stress, that is Cold, forms at once as the covering pole and the two function as one unit—as vacuum. Hence fire (negative) is H and O (polarised).

Space is that which has a frontier; in the cosmos it is of spherical form or the like. Energy is likewise circumscribed, otherwise it could not be energy; it is either static as a membrane, or as cohesive force in material, or dynamic when its path and functioning are restricted and defined, as in the electric current. Space as such is suction force.

Fire and water are a cycle, as likewise fire and vacuum, through mobility.

Now when is fire magnetism? When it is formed between two poles—the core and its surrounding stressfield.

Actually, even a positive fire requires a negative pole, but in one sense only, that is, to complete the circuit, as it were.

For example, in the case of a flame the connection is the air and indeed a mobile connection but not a mobile polar connection.

The air is to the flame, or positive expansive fire, what the surrounding oxygen stressfield is to the hydrogen core. But since the latter is formed and functions between two poles by mobile interaction it is magnetism, and since the core is in the glowing condition it is termed “glowing magnetism.”

It is, of course, real origin magnetism, because it was formed by exerting attraction upon itself.

This negative fire has the greatest suction force in Nature. Vacuum is suction force and it is thus the primary or origin vacuum.

All matter and material has fire in it, but in the latent form—the cohesive force or equalised out homogeneous stressfield of H and O. Friction between suitable materials converts the “frozen” cohesive energy into mass (as energy) and brings it to the glowing state and a spark ensues. Here is the crossing of two stressfields, the heat stress due to friction and the cohesive force at that point.

It may be said, that if this is the cause, heat and fire through friction releasing the Cohesive Force in material and converting this energy into mass and fire, then there must be a corresponding loss in material. There is.

On the other hand, fire can also disintegrate matter through suction.

Positive fire transforms matter into energy, which being free returns as static potential to the Ether. Here we have the breaking down of matter into energy—a destructive process!

Negative fire transforms the Ether into energy-material. Here we have the building up of energy into matter—a constructive process!

Positive fire must consist of matter as material.

Negative fire consists of matter as energy, that is, energy-material in the glowing condition.

CHAPTER XIV

FIRE (POSITIVE) OR FLAME

Fire (Positive), or Flame, is really impolar Ether out of matter (material), *e.g.* the flame of a candle, match, or lamp, etc. A flame is an etheric formation of hydrogen in the gaseous condition. A candle flame is a glowing etheric gas-mass. Air and flame are two likes in unlike condition. The flame is the glowing condition, exactly as in the negative fire—the latent vacuum (or ether) and glowing magnetism. The relationship in both cases is relatively comparable, but the conditions are different.

Every flame is a catalyser. Every flame is also a suction and force pump. It draws in air, catalyses it and forces it out. Its nourishment comes from the ether (cohesive force) in the material of the fuel.

Flame is, however, molecular force, it is not atomic force; it disintegrates or releases the atomic force in the material, that is the cohesive force. Flame is matter, fire is matter. A flame, say, from a match is so many times as big as its matter is lighter than the wood plus the oxygen. This means that a flame is the product of mobility, time and mass (matter); that is why the gas form is so much bigger than the solid form. A flame can consume a gram of matter inside a minute of time, and in each gram of matter there are 22×10^9 great calories, which accords with Jeans's figure of 9×10^{20} ergs.

In a match, matter is transformed into energy through fire. This enormous energy in each gram of matter is the atomic force of compression, which is converted in the flame into energy by mobility or energy transference. But since this is not polar mobility, the energy which is being continuously produced every minute in the flame cannot be

collected and this atomic force cannot therefore be utilised. If, however, we had a "collectible fire" (*Sammelfeuer*), the atomic force would at once be available as a negative fire—glowing magnetism in the Schappeller Stator, the true Atomic Force. A negative fire glows due to light-matter being formed by compression—light-matter is an energy-compression product.

Whether the secondary or positive fire is of wood, coal or metal, makes no difference; metals absorb heat stress, and this, compressed by the cohesive force of the metal, produces a heat source. Give this heat source water as a resistance, and steam or vapour is produced.

This serves to indicate that the present or positive fires have no mobile attractive force because they do not originate from polar mobility, they can only be used directly as a heat stress requiring a resistance such as the cohesive force of water.

A flame exerts a suction on the air and is thereby held by the air. Thus a potential difference between flame and air exists, and a potential difference is a source of power.

The flame is kinetic because it is in the glowing state and there is therefore mobility, but not polar mobility. In other words, the flame is magnetic, but no magnetism, as such, is available, because there is no polar mobility as in a negative fire.

As an example of two likes in unlike condition, steel can be brought to the glowing state—static, but immobile force, and glowing cohesive force. If the latter is overpowered, it results in the disintegration of the steel.

The sun is in the glowing state, but it is in another condition to material, the energy-form—polar mobile static force.

In the case of a fuel the flame draws or sucks on the cohesive force of the fuel, but in substances other than fuels (materials), heat stress, as above explained, is absorbed. Wood absorbs heat, but it is then easily combustible and is therefore not a permanent source of power. Flame is glowing atmosphere with air, but without polar potential difference—the other pole is missing.

FIRE (POSITIVE) OR FLAME

What causes the greatest resistance to fire? Water.

Water is H and O out of carbon, united as water through carbon again—ether, carbon energy, polarised as H and O and united through equalised H and O or carbon stressfield as water again, on the sun's periphery.

Water (liquid form) like air is a compression product out of the atmospheric stressfield, because the stressfield itself is derived from the central core, which is also H and O. It is equalised out H and O energy as a sublimate in liquid form, externally impolar or inactive, but internally having the characteristic of equalised or latent polarity. This means that water as such has no mobile interchange with objects external to itself. As Space-form it has adhesive force, derived from its cohesive force. The adhesive force can be dispersed by crossing it with a heat stress, when it takes the gaseous state as vapour or steam; but the cohesive force can only be penetrated and released by impolar mobility or pressure electrolysis, and the energy is not then collectible. When polarised it is fire (negative) or glowing magnetism. Hence water and fire are both H and O but in different conditions.

Water is H and O in chemical combination. When H and O combine chemically as gases, it is really an "energy combination," that is, H and O energies combining, but this is screened from the physicist because it takes place here when the H and O energies are clothed as gases. This "chemical combination" is effected only by combustion or "fire." Therefore water is a derivative of fire, and has fire latent within it, differing from fire only as regards form.

All forces gravitate to a compressive or concentric negative fire, whereas a positive fire disperses all energies.

Positive fire disturbs all forces. It disintegrates cohesive force.

Negative fire collects all forces through mobility. It is cohesive force in the ideal state as pure energy, whereas in material it is equalised out, giving and maintaining Space-form through tensile, compression and shear strength.

Ordinary chemistry is the building up of molecules by combining the atoms—in the secondary states.

The new atomic chemistry is transmutation through disintegration or splitting up of the cohesive force—and likewise in the secondary states of matter.

The Primary Physics functions by the building up of the atom in the primary state. Transmutation, that is, the building up of new substances through the splitting up of old ones, is unnecessary. Any substance can be built up by transpiration and “models,” except such substances as milk and blood, etc., which are the products or sublimates out of organic life; splitting or disintegration of the cohesive force is against the natural laws. Nature functions by building up, which in colloquial language is termed growth. All growth is the product of the functioning of the fundamental cycle. This is, as it were, Nature’s “cyclotron”—growth is energy catalysation within a potential difference and with “models” (explained in Appendix (2)).

Oxygen attaches itself to compression forces and then burns within them because it is the complementary component, but in fire (positive) not a polar component.

Flame is really ignited vacuum force, out of the cohesive force of the material in question, hence its suction force—and air instantly gravitates therein.

The adhesive force of the flame of a lighted match draws on the cohesive force of the material or wood of the match. The cohesive force is H and O energy, the wood disintegrates, the residue likewise, but not by polar disintegration—depolarisation—but by combustion.

We saw that the combustion of H and O as gases brought about change of state to the liquid form of water, occasioning what is termed chemical combination, whereas combustion in the solid state brings about disintegration. It follows that if fire is required to bring about the liquid state, the liquid state must have the characteristic of fire within it, that is, in its cohesive force, which is H and O. Likewise, the cohesive force of the solid state has this characteristic of fire, but here it is already “in combination,” and fire (positive) decomposes it, destroying its Space-form as a solid; whereas fire (negative) would disintegrate it entirely.

A *slow positive fire* is oxidisation, e.g. the rotting of

wood, where meteorological conditions enable the oxygen in the air to exert suction on the H and O cohesive force of the wood, thereby decomposing it.

A *more rapid positive fire* is the same process of oxidisation, but more rapid, thus producing flame, and with the same ultimate result.

A *very rapid positive fire* produces nearly instantaneously decomposition as in an explosive, positive fire being latent and available in the cohesive force of certain specific materials, when such materials are suitably arranged for the purpose of rapid combustion, the exact rate of which can be regulated by the form and arrangement of the materials.

The *ultra-rapid positive fire* produces simultaneous decomposition of the whole of the explosive material, known usually as "high explosive," causing not explosion, but ultra-explosion—detonation.

Substances glow due to their internal pressure, *i.e.* due to their capacity to draw in and store up heat.

Wood glows only when the right conditions are present and then it turns to coal (charcoal)—and coal is related to iron.

Iron glows when sufficient heat is applied because the internal stress is increased through the cohesive force compressing the heat stress, and this leads to the production of light-matter. If the heat stress overpowers the cohesive force, the material ignites or, in the case of iron, melts.

A pyrometer can thus only measure the heat given off from iron in the glowing state, not the actual internal temperature.

Iron glows even in a vacuum exactly as it does in air, but in a vacuum positive fire is instantly extinguished. It thus glows *in vacuo* because it is the actual static energy of the matter that is glowing, the cohesive force, H and O stress under its own internal pressure, the internal pressure of the cohesive force of the material, and not as positive fire which requires air to sustain it. (Internal pressure or cohesive force of material manifests itself as tensile, compressive and shear stress.)

The heat energy is sucked up by the energy or cohesive force of the iron, *i.e.* vacuum force, and, as previously explained, it (and all material) still retains this characteristic of vacuum force within itself, as the force of cohesion.

This brings us to:

Negative fire (or origin fire).

The first condition of water is fire.

Fire is the hydrogen sublimate out of the ether.

Fire is the sublimate, the sublimate is matter.

Fire produces form in space—core and its complementary stressfield.

Fire being matter must be surrounded by a stressfield or spherical energy wall to protect it from the air. This is very important in the Technique.

The cardinal characteristic of fire is suction.

To compress fire an opposite pole or complementary stressfield is necessary; then it becomes glowing magnetism. This is the basis of the new Technique.

CHAPTER XV

WATER

There are three conditions of water, as such:

1. Fluid state
2. Fluidal state
3. Electric state

all of which have their origin in fire (negative).
Everything is H and O in different forms.

Fluid state:—not a body, but material.

Fluidal state: — intermediate stage, between material and energy—unstable. Not another state of matter, merely a transition stage.

Electric state:—energy condition.

Water is formed through the proportional potential resistance of Cold stress; in other words, fire or heat must meet with resistance in order to form water, and this resistance must, as it were, constitute, and always proportionally, the opposite pole, as it does on the sun's periphery, viz. the hydrogen core and the cold oxygen stressfield.

There is no such thing as water without fire, because fire is the origin of water. Water as such is inactive but nothing is built without it—it is Nature's building material in its various forms.

Water is matter, a material—not a body because it has no form or shape—but it is fundamental matter for the Secondary States, just as the Ether is fundamental matter for the Primary State.

So Water is shapeless,
 Space is shapeless but,
 Space builds form (a cosmos),
 Air as such is shapeless, but being a peripheral
 product out of the earth's stressfield, its Space-
 form conforms to that of the earth's crust,
 Fire (a) positive has form,
 (b) negative has form.
 The Ether has form conditionally as cosmos.

Origin of Water.

Water originates from the PD between Heat and Cold as stresses—the Cold is its base (hydrogen fire and its cold complementary oxygen stressfield).

Fire exists in water and earth in the energy state as a homogeneous stressfield, and thus latent, because Water, Origin-fire, Cohesive Force in material, are all H and O. Polarise H and O and we obtain fire (negative); combine it chemically and we get water; subject cohesive force of material to friction, and fire (positive) is produced.

Second State of Water.

The second state of water is fluidal.

Fluidum is really material and energy but not energy-material. It is an unstable and transitory condition of the energy state when densifying.

In the case of water, Fluidum may be regarded as the transitory condition prior to the formation of vapour.

Water Subjected to Cold Stress.

One kilogram of ice is not a litre, but a litre of water is equal to a kilogram of 4° C. Thus, if water is subjected to cold stress, it draws itself together to form the solid state of matter, but in doing so expands; that is, a cubic foot of ice takes more space than the water it displaces. This, in principle, is all that the SP tells us. The point, however, here is: what draws itself together and why?

The H and O homogeneous stressfield exerts this force owing to the crossing of the two stressfields; in this case, the cohesive force of the water and the cold stress to which

we have subjected it. Its density increases down to 4° C. and then, as the temperature is lowered, it decreases; finally, more cold stress must be applied to overcome the latent heat of the water, and the water then changes to the fourth or solid state of matter.

What is the explanation of this?

In the secondary states we know that cold stress produces contraction, and this law holds here with water down to its maximum density point— 4° C. Down to this point the H and O stressfield (or cohesive force) of the water exerts greater and greater pressure due to these two component stresses acting through themselves in opposite directions, thus producing densification. But after the critical point, approximately 4° C. down to 0° C., the stressfield (H and O) begins to take up its magnetic structure preparatory to forming the crystalline state of water, known as ice; the formless liquid then expands on to its magnetic structure with reduction in density. So the expansion or decrease in density of the water between the critical temperature, viz. 4° C. and 0° C., is due to the formation, in the energy form, of the magnetic structure or pattern on which the new state—the solid state—of the substance will be built.

Metals contract when subjected to cold stress without change of state, and expand with heat stress.

Some metals, such as cast iron, expand, like water, when solidifying, whereas gold and silver contract.

Whether a material, when "changing state," contracts or expands, depends on the condition of the cohesive force of the material in question and the kind of magnetic structure which forms on solidifying. The material in question either "expands" on to the structure or "contracts" on to it.

Now if between 4° C. and 0° C. the cold stress were removed, the formation of the magnetic structure would cease, and the fluid as such would become formless and densify again up to its maximum at 4° C.

If the cold stress continues the crystalline form finally appears on the magnetic structure, accompanied by expansion, the density is reduced, and the ice, as we term it, will float on the liquid water. This, in a secondary state of

matter, is a case where cold stress produces expansion, for the reasons explained above. (Appendix (4).)

The explanation of the magnetic structure or, as a geologist would desire to term it, the tectonic (the equivalent of the skeleton in animal life) of the new structure is dealt with in Appendix (2). Suffice it, meanwhile, to say that every substance has its own pattern; Nature builds nothing without a pattern.

Perhaps the simplest structure which can exist in Nature is the snowflake, which is based on a variety of magnetic structures or patterns, and here all are apparently of hexagonal form.

Water Subjected to Heat Stress.

If, on the other hand, we subject water to heat stress at 100° C. (and at atmospheric pressure), it transforms it into vapour or the gaseous state. The actual gaseous state is dealt with separately later, under "steam," which is an expansive product.

Water provides a resistance to heat stress up to its critical temperature and corresponding pressure, then it transforms into the gaseous state. The resistance arises from the cohesive force—H and O stress—the static or atomic force—the equalised out H and O stressfield as cohesive force. But to break into the atomic or cohesive force of water, it is necessary to use an entirely different and more drastic process. The homogeneous stressfield of cohesive force must be separated, but not by polarisation, because, as has been explained, if we polarise H and O we obtain fire (negative) or glowing magnetism—it must therefore be separated without polar form. But we must always bear in mind that H and O are polar components and exert attraction upon one another even when clothed as gases; this is the reason that H and O is an explosive mixture when the right conditions obtain, because explosion is an *expansive reaction*, which must, according to Newton's Third Law, have its origin in an equal and opposite reaction—compression—which in the gaseous form is occasioned by chemical combination, that is, energy combination in

the gaseous state. This separation must therefore be carried out by pressure electrolysis, when the pressure of formation of the gas bubbles will be an indication of the cohesive force, or force of the equalised out homogeneous stressfield. This formation pressure is said to be many thousands of atmospheres—the figure 18,000 atmos. has been given for this.

This atomic force—basically the same as that which exists in material—is available, but not by this pressure electrolysis, only when the separation of H and O is effected by primary electrolysis, or mobile polar separation, forming glowing magnetism. Actually, in high pressure electrolysis there is no danger of the H and O exploding because their density by this process is too high, unless a very powerful catalyser is present.

So the production of a high steam pressure is no criterion of the tremendous force of this stressfield or of the cohesive force of water as such. The steam tables have been extended to 3000 lbs./in.² gauge pressure, say 200 atmos., which however is merely breaking into the adhesive force of the water—the “molecular cohesion”—as against 18,000 atmos. for the true cohesive or atomic force of water, as given by pressure electrolysis.

Now it has been stated that water and fire are really the same thing in different conditions. It should therefore be possible for water to burn, and it will and does if it is polarised and in the energy form—the sun and its complementary stressfield. The combination of these two on the sun's periphery reverses the process, and water is produced.

The Third State of Water.

The electric current is the third state of water but this cannot touch the cohesive force, only the adhesive force, in the electrolysis of water. In order to reach the cohesive force, glowing magnetism must be formed by polar interchange.

It may be said that it has just been explained that the cohesive force of water can be demonstrated by pressure electrolysis. Yes, demonstrated, but not collected and

utilised as the cohesive force remains intact in the bubbles formed.

Adhesive force can be reached by external means, but cohesive force only by polarisation. H and O have an affinity for one another; they are, as we have seen, the two bipolar components of magnetism, magnetism being thus H and O and the electric current being a product out of magnetism.

In an electric generator, as we shall see in Part II, there is nothing but a magnetic field from which to produce electric current; therefore, if water is H and O, the electric current is water in another condition.

Water is magnetism, but latent; this is the reason that if we pass an electric current into water, under the right conditions, we split up the latent liquid magnetism (water) into its two components because the current itself is composed of these same components. This, as we know, is what takes place under the process known as the electrolysis of water. This is the cycle, but a process cycle only, not the mobile cycle in Nature, which is continuous.

“We use electrical energy to generate hydrogen and oxygen and can regain it by chemical combination of these two gases in a cell.” (Grimsehl’s *Physics*, Vol. III, p. 288.)

Electricity is thus H and O energy. There is no difference in quality or characteristic between the current produced by an electric generator or a primary battery. If in the former the current is a sublimate out of a magnetic field, then the current from a primary battery must also be a product of a similar magnetic stress, although this magnetic stress does not have to be present as a magnetic or gauss field. It is, of course, a product of the cohesive force of the plate which is an equalised out homogeneous H and O stressfield, but the process of obtaining current here differs from that in the generator.

H and O are, as it were, North and South poles in water, but they are equalised out through one another as stress—a frozen stress with no mobility. Here H and O are functioning as cohesive force as they do in building and compacting material, where it is the origin of tensile, compressive and shear stress.

When by certain conditions of cold stress the characteristic magnetic structure of the substance in question can form, the material is said to become a solid.

Liquid water is a product out of a PD (H and O stress), and is only possible under specific conditions of temperature and pressure and within the earth's stressfield, that is, if the water is to remain as a permanent substance.

Water depends on the capillarity of the earth's crust, that is, the force which comes into being through the PD which exists there and the mobility with its complementary stressfield, and this is proportional to the size and intensity of the earth's central hydrogen core and thus to the diameter of the geoid.

The capillary force is significantly demonstrated in the fact that the metre is approximately and very closely 10^{-7} of the earth's meridian quadrant and that water rises approximately 10 metres, or 10^{-6} , of the earth's meridian quadrant under a torrecellian vacuum, suggesting that it bears a definite relationship to the diameter of the geoid and thus also to the central core.

CHAPTER XVI

WATER (IN RELATION TO THE SUN).

FORMATION OF SUN'S PERIPHERY

The overspilling and intermixing of H and O energy through the catastrophic action of two likes in unlike condition, at the sun's periphery, causes the formation of water as fluidum—densified energy—as it were the ashes from the combustion (implosion) process, but in energy form. Here it is very important to note that water could not exist even as vapour—the first of the secondary stages of water—if it did not exist first in the primary state or energy form. The gases, liquids and solids, should be regarded as being merely the clothing of the energy form.

An illustration has already been given to make this clear, that chemical combination is the combining of the energies. When these energies are clothed as gases, the proportion in the case of water is H_2O .

We speak of burning as oxidising; this is what takes place in the sun but as pure energy and *in vacuo*. But how, it may be asked, can oxidising or burning take place in a vacuum?

Let us make a digression in order to make this clear.

Put a piece of steel in a smithy fire until it glows; now remove it and place it in a vacuum (space without air) and it will still glow. Now take it out and let it cool. There is no visible loss of material and the steel has not been burnt. This is a compressive fire but in the secondary state of matter. The internal cohesive force, or homogeneous H and O static stressfield, has been increased or overfilled through the absorption of the heat stress from the fire, and the compressive force of the H and O stressfield has been raised until light-matter (photons) has been produced. In

other words, it is the energy that glows, but owing to the overfilling of the stressfield through absorption of the heat stress the metal must expand.

But to return to the sun; how can we speak of internal pressure on the periphery of the sun?

Oxidising or burning on the sun's periphery is really energy compression of the two components H and O, which takes place in the secondary state of internal stress. The sun can only act energy on energy. There is at this stage no material.

From the glowing or primary implosion water is formed, first as fluidum, then it cools, or condenses to vapour, finally to the liquid form as water.

From one standpoint plus 4° C. will be zero for the new Technique.

Vapour or moisture cannot arise out of solids, the solids must be formed in the vapours or moisture.

Water is Nature's mortar which as a stressfield holds the "bricks," the materials, together. In the cosmos, energy (static) first, then gases, liquids and solids. But life (organic), from which all material comes, must be born in water. Then, and then only, is organic life possible, through origin dynamic or spiral energy, known in the PP as entropy and explained later.

Let there be no misconception here; the statement has not been made that water is life, or that water builds life, both of which are false, but that organic life can only form in water.

The death of organisms builds the first solid insulating layer between the polarity of heat and cold (H and O energy on sun's periphery), and in this potential difference, mobility and then capillarity is born.

In the PP capillarity is the force which is produced only where a potential difference occurs; it manifests itself in the SP or secondary states in hair-like or narrow tubes, hence the origin of the word. But it is a force of attraction or repulsion and originates in and through a PD.

In the primary state, where capillarity has its origin, it is the attraction and dynamic of Space itself.

other words, it is the energy that glows, but owing to the overfilling of the stressfield through absorption of the heat stress the metal must expand.

But to return to the sun; how can we speak of internal pressure on the periphery of the sun?

Oxidising or burning on the sun's periphery is really energy compression of the two components H and O, which takes place in the secondary state of internal stress. The sun can only act energy on energy. There is at this stage no material.

From the glowing or primary implosion water is formed, first as fluidum, then it cools, or condenses to vapour, finally to the liquid form as water.

From one standpoint plus 4° C. will be zero for the new Technique.

Vapour or moisture cannot arise out of solids, the solids must be formed in the vapours or moisture.

Water is Nature's mortar which as a stressfield holds the "bricks," the materials, together. In the cosmos, energy (static) first, then gases, liquids and solids. But life (organic), from which all material comes, must be born in water. Then, and then only, is organic life possible, through origin dynamic or spiral energy, known in the PP as entropy and explained later.

Let there be no misconception here; the statement has not been made that water is life, or that water builds life, both of which are false, but that organic life can only form in water.

The death of organisms builds the first solid insulating layer between the polarity of heat and cold (H and O energy on sun's periphery), and in this potential difference, mobility and then capillarity is born.

In the PP capillarity is the force which is produced only where a potential difference occurs; it manifests itself in the SP or secondary states in hair-like or narrow tubes, hence the origin of the word. But it is a force of attraction or repulsion and originates in and through a PD.

In the primary state, where capillarity has its origin, it is the attraction and dynamic of Space itself.

CHAPTER XVII

PRIMARY WATER CYCLE

The Sun. First Fire (magnetism) is formed, then fluidum, then a surface or periphery. This surface is not the same as the internal portion of the sun's core; it exists only under catastrophic magnetic storms or peripheral interaction or mobility in which hydrogen—the German word for which is “waterstuff” (*Wasserstoff*)—under specific circumstances condenses to water, forming an insulating layer, and finally by organic means a crust is formed.

The primary water cycle, where water itself originates, is due to the drawing in of the oxygen stressfield into the hydrogen core by suction or rather by primary magnetic attraction—two likes in unlike condition or two unlike mobile poles—then catalysation in the core of the oxygen stressfield and finally radiation of this stimulated stressfield out and across the sun's periphery into space. This is the origin-cause of water, air, and an earth's crust, of life on the earth, in fact of everything which exists in any heavenly body, but of course there are various stages of development. It is not occasioned merely as explained here, in this paragraph. It is a very complex process of action and interaction, of energy, fluidum, vapour, moisture, water, in which organic life forms—also a complex process—and finally compacts and solidifies under the great potential difference to a plastic and then a solid crust.

The word “hydrogen” is from the Greek; it means water, but more than that. Gen- is a suffix which means “to be born in a certain place or condition”; here it is born in the point of inequality occurring in space as a core—the first condition or ingredient of water.

That which in the sun is radiation here on this earth is water, a condensate out of magnetism, out of the "earth's sun," or core. This is the origin of the Internal and External Water Cycles mentioned in Chapter V, and the origin cause of all meteorological phenomena. The first condition of water is fire, therefore water originates in "energy form" from the hydrogen core and complementary oxygen stress-field which permeates the crust and exists as a stressfield for millions of miles beyond it.

Within the earth's crust the Internal Water Cycle functions in the energy form, promoting an External Water Cycle which functions as vapour and liquid water. The External Cycle is, of course, the familiar evaporation and condensation which takes place on the earth's periphery, in the air, and within the extreme outer portion of the actual crust. The whole core, with its stressfield, is magnetism, therefore the derivatives and sublimates, air and water, possess this characteristic within themselves; water as vapour or liquid is thus latent magnetism.

Evaporation or concentration of water vapour into clouds is really a magnetic process but in a latent condition. Evaporation or concentration of water vapour into clouds is effected by transpiration. (See Chapter II, Definitions.) Herein lies the whole origin of meteorological phenomena, all of which must and do arise from the central core, its fluctuations, and also the interaction with the complementary stressfield modified and qualified by cosmic influences.

CHAPTER XVIII

STEAM (GENERATION)

In order to generate steam we must first have the crossing of two stressfields. The one is already there and cannot be altered—the cohesive force of the water, or equalised out homogeneous H and O stressfields—and the other must be supplied. It must be a heat stressfield, produced in any convenient heat source, *e.g.* a fire or furnace, or by any other suitable means.

When the heat stress is applied, the crossing of the two stressfields produces primary compression; that is, the stress structure, or field of the water, is subjected to compression and the adhesive force—or what may be termed the “molecular cohesion”—is lifted or reduced finally to a point where the water, as such, changes its state and forms into spherical globules or spheres, which are simply H and O spheres with a specific charge or stress. The charge is a heat not an electrical stress. It could not be electrical stress because it can only come from what was there, *viz.* heat stress and adhesive force in the liquid state; the cohesive force, as has been explained, can only be reached by pressure electrolysis, and this can only cause separation, not transformation into another form of energy.

There is no Nernst effect here or the like, for this very reason that the cohesive force as such only plays the part of a resistance in the generation of the steam.

If, however, we desire to obtain electricity from steam generation, then the steam vapour must receive or be crossed by an electric field or charge. The electrified bubbles will then react to centripetal action, conglobate and densify, light-matter will be formed and thus glowing magnetism; in other words, lightning material, similarly to the way in which it is actually formed in Nature in the clouds.

This highly dangerous and insane method of producing lightning material or glowing magnetism artificially has been tried and has failed but not without loss of life, because the experimenters were in ignorance of the laws. Success would have meant a greater catastrophe. And those who know the laws would produce glowing magnetism in the proper way.

But to return to the generation of steam. Because it is stated that only the adhesive force is reached, do not let it be assumed that the cohesive force plays no part in steam generation. On the contrary, it provides the resistance without which separation could not take place. The heat stress would simply pass through the water and be absorbed by it, and in the language of present physics, the temperature would be raised, which, as we know, is exactly what happens but only up to the critical temperature. Then a further quantity of heat must be applied to release, as it were, the molecular or adhesive force against the resistance of the cohesive or atomic force, so that change of state may ensue; that is, release from the liquid to the gaseous form.

The power of steam is obtained from the "Might" or static potential or cohesive force of the water through the resistance it offers. (If the experiment were arranged differently, in fact in the reverse order, negatively, as compression, the cohesive force of the water would then produce glowing magnetism, as is the case when lightning material is formed.) But, as has been explained, this experiment is dangerous and liable to lead to a major catastrophe—it is fortunately and providentially extremely difficult to carry out. So the power of steam resides in the cohesive force of the water through the resistance it offers. Each steam bubble has absorbed part of the heat stress and is thus capable of exerting pressure.

It may be contended that the pressure on the sides of a boiler or tube is exerted owing to the mass of steam bubbles. Exactly so, but the steam bubbles have the elasticity to *transmit* this pressure. The force of steam, therefore, depends on the force which lies in water and is released

STEAM (GENERATION)

by a heat stress; that is, the resistance which the water offers to the heat stress.

Steam as such has no discipline but occasions a whole discipline or technique. It is also derived from an ordered form or discipline. The bubble constitutes a discipline, it has definite form and is specifically stressed. It is an H and O energy sphere stressed and tensioned with specific charge, possessing elasticity.

If we take one litre of water and turn it into 100 litres of vapour, there is nevertheless only one litre of water available to supply the envelope of all the bubbles, the remaining 99 litres are free energy (calories).

The litre of water in the envelopes is also the resistance in the free state which enables the expansive force to be exerted. We had stress and resistance in the water and we see this same stress or resistance in the steam or vapour.

If we continue to supply heat stress, as we do in a superheater, our bubbles, as such, are destroyed, that is, they are turned into gaseous energy and the whole then functions as a homogeneous gas.

Simple condensation will no longer condense this steam, because it exists no longer as a mass of bubbles. If we wish to condense it we must reverse the process and supply compressive stress instead of heat; this will again densify the gaseous condition of the H and O gaseous mass and finally the saturated condition will be reached. The steam or vapour can then be condensed by cooling.

The two processes of compression and cooling can, of course, be simultaneous, but this is a technical detail. The fact remains that the enthalpy of superheated steam is the sum of the internal stress imparted to the water, which is equal to the spherical stress of the bubbles, plus that required to dissolve these energy spheres or bubbles to a homogeneous gaseous state or the like.

The first is internal stress, the second is external from another heat source. The thermodynamic function is the transformed internal stress or compressive force due to the crossing of the stressfields under the conditions of generation, and this is the subsequent $U + pv$.

So steam is water plus heat stress and it is nothing else, because there is nothing else available.

The air's stressfield is derived from the atmospheric stressfield, the energy "framework" to which it owes its origin and maintenance, just as the steam owes its origin and maintenance to the heat stress functioning on the cohesive force of the water as a resistance. This has been previously explained.

CHAPTER XIX

AIR

The air is an etheric product out of static Space, out of which it was created. It is a chemico-physical product of the Ether stress. It is supported by this atmospheric stress, by and through it, and its own stress. It is an arc stressfield of force and matter.

Air is gravitationally held to a physical centre. No air can exist in Space as such—it could not be formed and it could not exist. Air is essentially an arc or peripheral product of an organic earth. There is no such thing as a dead earth, there is a dying earth—the moon—and when mobility ceases it will die, that is disintegrate. The stressfield in the moon is not strong enough or dense enough to produce air. The moon, of course, has its atmosphere like the earth, but very little or no air; the atmosphere being a stressfield, and the air being a product or, better expressed, a gaseous sublimate out of that stressfield.

A gas is really a release product out of Potential, an expansive product, or rather a product of expansion, but not the air.

The air is a product of compression, an ionisation product through the crossing of the atmospheric stressfields—the earth's and sun's stressfield—but only a peripheral product, as are all other such products—light, heat and water.

Like water, air is latent magnetism, but in gaseous, not in liquid form.

Air is a matter-membrane; the Ether, as we have seen, is an energy-membrane. The air is thus not a polarisation product with two polar components, but an ionisation product; not separation by polarisation, but by stripping or ionising.

Now, if the air is a sublimate, concentrate or "ionisate" (if this latter term is permissible), it can only be composed of what it came from. The stressfields are static potential of latent magnetism. Magnetism in the primary state, or as a matter of fact in any state, is H and O energy. We know from chemistry that air is mainly nitrogen and oxygen. Nitrogen is hydrogen in another form, converted by primary combustion or compression. The product in its new form is no longer polar and capable of mobile exchange; in its gaseous clothing it is inert. The actual combining proportions were dictated by the sense-energy, or conscious-physical core, to enable its physical earth (the earth came from the core and its complementary stressfield) to perform the particular function allotted to it as a specific and purposeful cosmic body—in this case to produce and maintain organic life. Air must therefore have the right proportions of O and N for this purpose.

The atmospheric stressfield is H and O and the O remains but is converted to gaseous form.

Now the question may be asked that since the Ether is a static homogeneous potential of oxygen and hydrogen, why is it only the hydrogen component that changes its form from hydrogen to nitrogen, whilst the oxygen remains as oxygen with only change of state.

Let us not forget, however, that although they are both equally components of the ether, they act very differently on polarisation. The hydrogen concentrates, forming an energy sublimate (glowing magnetism). When therefore compression of stressfields at the earth's periphery takes place, the hydrogen again forms the sublimate, this time in a gaseous state, and, since it is not polarisation but separation through a form of combustion, its form is also changed.

It is also not surprising to find that from this primary form of combustion there is an ash or residue, also of course in gaseous form, what is known as the rare or noble gases.

It is likewise interesting to note that the two principal paramagnetic gases are oxygen and a compound of nitrogen, nitric oxide gas—the simple compound of the two principal constituents of the air with the chemical formula NO.

The air is latent magnetism in the gaseous form. Naturally the gaseous to be stable must be formed and ionised by transpiration and mobility from the central negative fire, the earth's hydrogen, which is also the origin of all moisture necessary to form a gaseous state.

The air is thus a product of what was there and available, viz. the oxygen stressfield and hydrogen converted through burning or oxidisation to its inert form, nitrogen—the combustion taking place through primary compression of the stressfield, or ionisation.

It is an arc-product of the earth's stressfield, because it is and can only be formed at the earth's periphery and is held gravitationally to the core.

The stressfield from which it arises is, of course, the hydrogen core, whose field saturates the earth's crust, densifying or sublimating at the periphery, against the bound stressfield in the earth's crust, and thus by energy-compression, *i.e.* compression of the stressfield as such, energy-combustion or ionisation, converts the hydrogen through this oxidising to the gaseous state as nitrogen, the surplus oxygen remaining, plus a residue—the noble gases.

CHAPTER XX

EARTH

(THE BUILDING OF AN EARTH'S CRUST)

Let us proceed from the physical origin.

First homogeneous Space, the texture of which is carbon static energy—potential. This carbon potential consists of two polar components, viz. oxygen and hydrogen energy. When a point of inequality occurs in the otherwise homogeneous static Ether, the hydrogen component conglobates on to the point of inequality, due to its characteristic of exerting attraction upon itself (the true primary magnetism), finally densifying to a critical point when light-matter is formed, and this hydrogen core is then in the glowing state—glowing magnetism—primary vacuum, exerting attraction and repulsion on the complementary ether component which forms around this hydrogen core—the oxygen stressfield.

Attraction or suction are two words which really express the same force under different conditions, *e.g.* a keeper is attracted to the poles of a magnet—but this attractive force is suction. Likewise the cold oxygen stressfield is sucked in, catalysed and forced out as radiation. This functioning of attraction and repulsion, of suction and the reverse, is “magnetic breathing,” transpiration, energy transference, mobility. But let us be quite clear on this point: mobility means the oxygen-hydrogen interpolar pull exerted within and through itself as such; this is magnetic suction or the reverse, this is magnetic force.

It may be asked, is it the same force as that existing between a magnet and a keeper? No, not exactly; but this is explained elsewhere—it could not be the same because in

the magnet the energy is bound and immobile (not glowing magnetism capable of setting up and maintaining an energy cycle).

The two likes in unlike condition, the cold oxygen stressfield and the hot or warm glowing hydrogen core, constitute a potential difference, the greatest which exists in Nature, and the greatest source of power. (See Chapter VI, page 64.)

Again, it may be asked if it is this potential difference which is the direct cause of mobility, that is, of the sun's tremendous vacuum force? No, the potential difference is only the direct cause of entropy, the entropic spiral, and this is the direct cause of the sun's mobility. But the entropic spiral and entropy must be explained separately as it would confuse the issue if it were to be made the subject of a digression here. (See Chapter XXII.)

To keep its mobility, the sun must travel with its whole stressfield so that it has continually fresh material to catalyse, as it catalyses through its stressfield, and its stressfield is bound by mobility to it.

Now, the point of inequality in the homogeneous Ether is caused by a sun building a crust and becoming an earth, when its motion through space must cease.

It should be clearly understood that motion in cosmic bodies must be quite differently visualised from that of motion of material bodies on the earth. Energy in motion is different from material in motion, and the sun is essentially energy in static mobile condition. The sun's whole stressfield travels with it as one, because it is derived from it.

A crust is not formed "by numbers." *The conditions of formation are catastrophic*—the insulating film finally being flashed into being, and energy-material, or in this case a sun, would then cease to move. The reasons have been given.

The electric current, for example, is said to travel at 300,000 km. per sec.; when the circuit is broken it instantly ceases to move because it ceases to be an electric current, and the sun ceases to be a sun, instantly, when the insulating film is complete, and exterior mobility ceases.

The magnetic field of the sun (from its hydrogen core) now concentrates on a point in space—its motion having ceased owing to the film or crust which is forming an insulator to external dynamic. The new sun is formed at approximately the square of the lately formed earth's diameter in kilometres (not miles). The sun's mean distance from the earth is, according to the Paris Conference (1911), 149,450,000 kilometres. The square root of this is 12,222 kilometres and the earth's equatorial diameter is 12,757, in itself a negligible discrepancy. So this calculation agrees very nicely, except for the fact that we cannot consider the earth's diameter as the peripheral diameter across the crust, since the magnetic field can only function through space from the core; the saturation of the crust merely being responsible for our terrestrial field. If we take the thickness of the crust as 1/6th of the total diameter, then the magnetic core is only 2/3rds of 12,757 kilometres, and our statement that the new sun is formed at the square of the distance of the earth's diameter—in this case the core's diameter—is entirely false.

There are, however, two other factors which have to be considered, viz. the sun's mean orbital distance from the earth was more than likely the distance at which it was formed by the previous sun which was just forming a crust and becoming an earth, the distance before its orbital motion commenced, viz. 149,450,000 kilometres. (See Appendix (1).)

The second consideration is, what was the diameter of the core when the crust was forming? Now, since the crust was only a film and no appreciable contraction had taken place, it may be taken to be about the earth's present diameter, in which case our statement still holds.

Having seen how the point of inequality is formed in the homogeneous Ether, and previously how the hydrogen core is formed and becomes a sun, let us now examine the problem of how the sun becomes an earth; in other words, how, for example, our present earth built its crust after it had functioned for æons of time as a sun.

The sequence is somewhat as follows. This loose phraseology introducing the word "somewhat," is to indicate

that the sequence about to be described does not take place like the different phases of the Carnot, Rankine, or Otto cycles. These are artificial cycles in that they take place within the closed walls of a cylinder and through some form of mechanism.

In the words of Goethe: *Was künstlich ist gebraucht geschlossenen Raum* (that which is artificial requires a closed space). Therefore such cycles are merely a cyclic series of operations, and are not "energy cycles."

In Nature, the sequence takes place in open or free space and the process is a continuous one. The crust of this earth was woven by free energies, but material was also necessary because, as we have seen, energy alone cannot produce material. The transpiration, or breathing between the core and its surrounding and complementary stressfield, is the loom or weaving mechanism functioning at the periphery, the over-spilling between the hydrogen core and oxygen stressfield resulting in chemical combination—or the combining of the energies, but without gaseous clothing—that is in the pure energy form.

Water is thus formed first as fluidum, then as vapour, finally condensing to the liquid state.

There is a relative heat potential between the core and the surrounding stressfield, although the sun is not hot in the sense of enormous temperature—high temperatures attributed to the sun being really a measure on the temperature scale of the sun's density. So between this heat and cold potential condensation takes place—water, in a previous chapter, having been defined as the proportional potential resistance force of heat and cold stress. This condensation film acts as an insulating layer between the hydrogen core and its oxygen stressfield. The water film cannot exist as such owing to the catastrophic conditions at the sun's periphery, but it is constantly being generated and thus replenished until the film becomes permanent. In this film the entity- or energy-frames of enormous marine animals were present. Nothing in Nature is or can be built without a pattern and a conscious energy organism is built on its energy frame or energy entity, in which it is complete in

every organ, but in the energy form only, and these first marine animals required the proper condition—water.

The marine life entered into the gaseous or vapour state, drawing or sucking in the carbon-static. The death of these vast organisms brought the peripheral film to the plastic or gel state; on becoming a solid having stable Space-form, it became virtually silica, and permutations of this in rock form were derivatives. Silica, being converted carbon, oxidised, the oxygen being present in abundance as the complementary stressfield. We have a somewhat similar example of this in the vapour state in the conversion of hydrogen to nitrogen.

It will be asked, how did the entities get there? In the same way that the Ether itself was built; they are the later work of the Creator. The entity-frames or energy consciousness are biomagnetic stressfields and form life individuals, but not yet organisms, they do not require water except to build organisms and for this purpose the weaving mechanism must be available, and in this way these organisms are born but only to die instantly, as no single organism could continue to exist under such conditions. But more and more were being born and died and so the first material was laid down and compacted between the potential difference.

Life and death are bipolar—here life builds material and death compacts it. But it may be contended that there is no geological evidence that the earliest rocks are of organic origin. The fact that there is no visible evidence is no evidence at all that the first material was not organic.

It is not surprising to find that the earliest rocks formed and compacted in this way have long since lost all trace of their organic origin, through metamorphosis, and the catastrophic magnetic conditions under which these earliest formations were laid down.

Gradually the marine animals became relatively smaller and smaller, and as conditions became more stable, the plastic state set in and finally the solid state, and the sun that *was* had now become an earth with a crust, as yet, of course, uninhabitable by terrestrial animal life of any

sort, and millions of years had to pass before it could appear.

But during this period, the earth's mobility—that is, the energy transference or circulation between its core and crust—continued to weave and supply sublimates; first, the gaseous sublimate, air, and then water.

This mobility was not concerned with enabling the earth to feed on its stressfield—it could not continue to do that owing to the crust. It was employed in promoting and sustaining growth. It was not a dead earth, as some biologists would have us believe, but a living earth, living through the biomagnetic conscious energy of the core interrelated with its complementary stressfield.

But the polar sequence of life and death continued, animalia became smaller and organisms had a longer life. Various terrestrial cycles were started, including animalia, but not yet of course the human or even the biped cycle.

It would serve no purpose at this stage to pursue further the growth of organic life and death, and thus the birth of material. The important point to be grasped is that the earth's crust constitutes a bipolar endosmosis of life and death; *os* means godly, *mos* something which grows, and the whole word signifies "the ultimate product of the work of the Divine or creative force."

The precipitate from a galvanic battery is "endosmosis," and the earth is a galvanic battery, the precipitate of which is the crust—the battery precipitate is an artificial secondary form. In the case of an earth the plates or electrodes are the earth's crust and the surrounding stressfield, both of which are saturated or rather receive their field from the central core. In the case of the crust the stressfield is bound, and outside in the surrounding space it is free, and between the two is the potential difference, the greatest that can exist. It is only necessary to find the connecting link between the two—to complete the circuit or rather the energy cycle—to act as a catalyst, and this is, of course, "glowing magnetism."

Now, everything which is an endosmosis of a physical centre must in form be the circumference of a circle,

therefore all products or sublimates of this physical centre must be circumferential—the earth's solid crust, the air, and water, all products of a stressfield periphery, are circumferential sublimates in solid, gaseous and liquid form respectively. (The sublimates came in this sequence, but as we saw previously, the states followed in the sequence: energy, gaseous, liquid and solid, to form the solid crust sublimate.)

Mathematically expressed, the parameter of the endosmosis of a physical centre—be it energy, gaseous, liquid or solid—is circumferential.

Water finds its own level, but its own level is always tangential to the radius of the earth's circumference. In other words, the surface of an area of water is always part of a circle, whether the area under consideration is a vast ocean adjoining two continents, or merely the surface of liquid in a tea-cup.

Water, therefore, as are all the other primary sublimates, is a circumferential force or potential. The further products, such as organic life, are all circumferentially bound.

Whether we live on a plateau in mountainous districts or spend our lives on the sea, we carry in our minds a datum line which we know is the normal level, usually sea level—a straight line which is never for one instant straight, because it is part of a circumference. It must be so, because water is latent liquid magnetism since it is derived from the magnetic potential difference between the core and its surrounding stressfield, and this magnetic potential difference is itself circumferential.

The earth is thus a spherical magnet and all sublimates must likewise be circumferential to this gravitational force, as they themselves are all potential gravitational forces—potential, in that in their state as sublimates their force is latent.

So growth, the building not the splitting of the atom, takes place between this potential difference earth-atmosphere (stressfield), just as the earth's crust was a product of this potential difference—the loom, or weaving mechanism.

EARTH

The organic entities constituted the pattern upon which the organisms were to be woven—thus producing life. The whole business of the earth as an entity, let there be no mistake, a living entity, is naturally the production of organic life. It was born and exists only for this purpose.

CHAPTER XXI

THE EARTH'S MOTION

“The earth is a particle thrown off from a rotating sun which thus gives the earth its rotational motion.” This theory is put forward, and not without evidence and justification, but it is hardly, as yet, an established scientific fact.

If the earth did not rotate how should we explain this and that? Since the earth does rotate on its axis, it explains the earth's prevailing wind from west to east, the direction in which the earth is supposed to rotate, likewise the earth's precession, the functioning of the gyroscopic clock and Foucault pendulum, night and day, and the relative motions of the whole planetarium; nevertheless, the earth's rotation is entirely unproven.

We have seen how a sun is born and how after millions of years a crust is built; how the earth becomes a moon, and finally disintegrates—the life and death of an organic heavenly body.

There is apparently among many scientific teachers and scientists the delightfully comfortable hypothesis that it makes really very little difference whether the earth revolves round the sun or the sun round the earth; that it is in any case merely a question of relative motion.

Two trains, each having a velocity of 45 m.p.h. in opposite directions, pass one another; if the lengths of the two trains are known, how long will they take to pass from the time the locomotives are just side by side till the guards' vans at the ends of the trains are just clear? A very confusing problem, but easily solved if we consider the one train to be stationary and the other to be moving past it at 90 m.p.h. But solving the problem in this way does not determine the position of the two trains after they have just

passed one another, relatively to some fixed point. Neither does it establish the cause of their motion, which in this particular problem is, of course, known.

No mechanism has as yet been established which explains the revolution of the crusts of heavenly bodies; the rotation of their magnetic fields is discussed later in this chapter.

Now we observe that the sun apparently rises in the east and sets in the west, therefore if the earth's crust rotated on its axis it would rotate from west to east, or looking towards the North Pole the rotation is clockwise.

But if the sun rotates round the earth and the earth does not rotate on its axis, then in order that the sun shall still "rise in the east," according to our vision, and set in the west, the sun must be travelling from our east to our west, and it has already been explained that it is the earth's magnetic hydrogen core—or source of its stressfield—which rotates, and even then only as a resultant stimulation, such as takes place in an induction motor.

The sun originated due to the concentration of the earth's magnetic field and is thus embedded in it. The sun therefore carries the earth's magnetic field round with it in its diurnal motion.

Light is the product of the crossing of two stressfields, and that portion of the earth's hydrogen core which is subjected to the sun's radiation at any given period of time is producing light and heat. When the sun sets on any given area of the earth's surface, obviously no more light on that part of the surface is produced as that segment of the core is not stimulated, and we have the hours of darkness.

But what of "the earth's prevailing wind"?—surely it is now from east to west. No, this is not caused by relative motion between the air and the earth's periphery. The cause of the prevailing wind is due primarily to fluctuation and rotation of the earth's magnetic field and the inertia of the interdependent air envelope. Let it, however, be clearly understood that the Schappeller planetarium will be quite different from the Ptolemaic or any other theories of

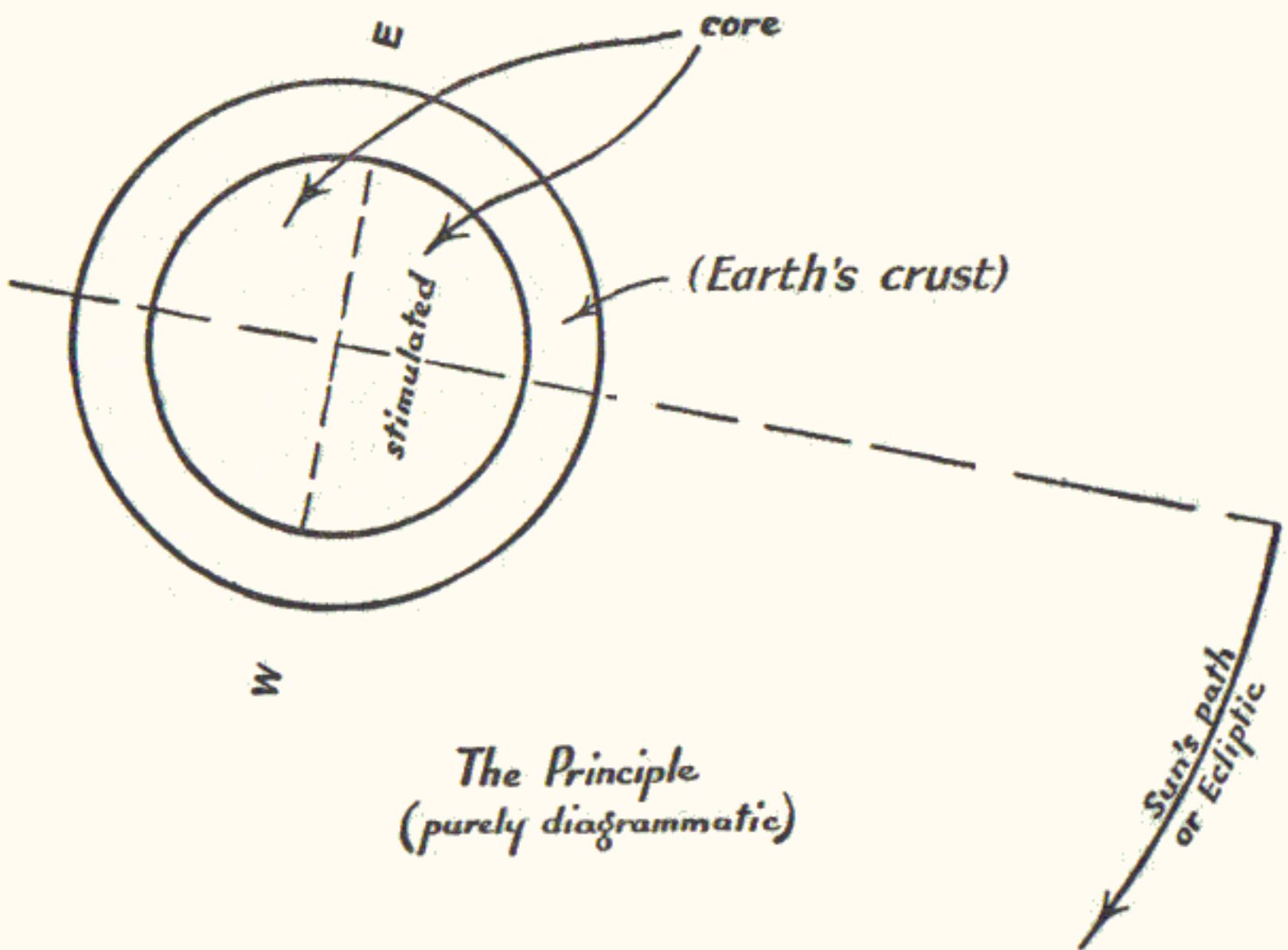

FIG. 5

planetary motion, as relative motions are not the only factor to be considered.

Furthermore, remember that the Ether is biomagnetic conscious force. Every heavenly body formed must first be a glowing hydrogen core, but it does not, on forming a crust, have to form another sun.

Heavenly bodies are not impersonal; it may be an endless, it is definitely not an aimless, evolution of worlds, but the vital plan of the Creator.

The relative rarity of life (organic) in the Cosmos, even if we are correct in this surmise, is not a measure of the importance which the Creator attaches to it. It could not possibly be, because He Himself is the Universal Consciousness, the source of all life.

The secrets of the Universe do not lie in the geometry of relative motion; the Creator's plan is biogeometric; herein lies the dynamic of the Universe—the cosmogony.

The law of the conservation of electricity lies in the centripetal action of the ether—the origin creative force.

The chemical affinity of matter depends on the force of attraction exerted by "energy material": a sun, glowing hydrogen core—glowing magnetism.

Magnetism, as known to-day, is described as an "attractive force" or a force exerting attraction, but it exerts attraction only when it is bound to material and between materials—never upon itself.

Obviously, if this form of static energy known as magnetism is an attractive force, then in the free state as primary magnetism—polarised (before polarisation it is latent)—it must exert attraction upon itself, and it does in forming the hydrogen core, and thus arises this characteristic of centripetal compression, building energy material—in the cosmos a sun, in the air "lightning material." In the cosmos the static electromagnetic energy is conserved, in the air it is released by discharge as lightning flash, because it is not vacuum, it has no corresponding envelope or opposite pole. Air does not serve this purpose; it is in the gaseous state, not the energy form. Conservation of static electromagnetic energy requires its corresponding complementary oxygen stressfield.

The origin of the Cosmic Dynamic resides in the vacuum produced—two likes in unlike condition, e.g. the sun—and the functioning of vacua on vacua.

These three facts or laws are the basic explanation of heavenly bodies—their formation, the rotation of their fields, the conservation of their cores and the magnetic interaction, attraction or repulsion; likewise the internal or external exchange or circulation between their cores and the surrounding complementary stressfield through their crusts as *neutral*, promoting and supporting life. The mechanism in the cosmos is vacua on vacua and the interlocking results in the rotation of the magnetic fields of heavenly bodies, as shown in the diagram on page 132.

CHAPTER XXII

ENTROPY

The dictionary definition from the Greek is “a turning point.” It is used in thermodynamics to mean “a transformation content.” We are not concerned here with the latter. In the PP entropy means *winding inward in spiral form*.

Entropy is an independent force, it comes into existence only when a potential difference is present, it thus has discipline and form—it is as it were the mainspring (in the energy form) which functions the primary cycle. The sun’s mobility or energy circulation is due to it.

The author, among others, has seen the sun’s entropy spiral reflected in a basin of water; its frequency, so far as he can remember, would be of the order of 25 cycles per minute. One complete cycle would be, starting, say, from the greatest spiral diameter, a rotation inwards to a centre and then outwards to the point where we started on the spiral’s apparent maximum circumference, but always with no change of sense.

The reflection was clockwise, therefore the sun’s actual spiral is counter-clockwise in sense to us. This is the cause of the sun’s transpiration, breathing, suction force, magnetic force; but the sun’s actual frequency may be very high, perhaps of the order of 10^6 cycles per second; the apparent frequency only being a fractional multiple of it—the lag being due to the time required to reproduce the spiral as light-matter, by the crossing of the sun’s and earth’s stress-fields, the way, as has previously been explained, in which light on this earth is produced.

Every heavenly body has a glowing core and therefore an entropic spiral; the earth, of course, likewise.

Entropy is thus a “conditional” force, the essential

condition being a potential difference due to two like energies in unlike condition.

There is no entropic spiral between the electrodes of an electric current, because the above condition is not fulfilled.

In a *reversible process* the force remains constant, *e.g.* the sun is a reversible process in the sense that it is a complete cycle of energy, so long as it remains a sun. But after a period of time it may become an *irreversible process*, then the force will not remain constant, but will produce material and promote growth—in other words, in this case it will form a crust.

These two laws regarding true entropy are the discovery of Professor Brendt (German physicist).

The irreversible process exists only as a natural process.

The following are some examples of *reversible entropy processes*:

The force or energy generated remains constant.	{	The sun. The new Schappeller Stator (or prime mover). The present electric generators.* Electrolysis. A candle-flame, etc., etc.
---	---	--

The following are examples of *irreversible entropy processes*:

Production and growth of material.	{	A tree—material in one sense is stored-up atomic force—this is an entropy law, since a tree and its energy grow, but a tree which has been cut down, or where wood has been cut from it, belongs to the reversible cyclic process, because when this cut tree or its wood is burnt, the same force or energy is reconverted into another form—decay or oxidisation.
------------------------------------	---	---

* In an electric generator there is no “growth”—increase or decrease in applied force merely gives a corresponding increase or decrease in the current generated.

So a tree belongs to the irreversible cyclic entropy process and it grows continuously because it is converting force or energy into matter—matter as material through entropic weaving.

It will now be asked if the tree has an entropic spiral. Certainly; it is the entropic spiral which causes growth in any form, either in flora or fauna, as all organic life is the product of the same and only potential difference between the earth's periphery and its surrounding atmospheric stress-field through entropic action.

What about the two likes in unlike condition, as we have here no glowing and cold magnetism? No, that is why energy is being transformed into matter; whereas the reversible process is purely an energy process in which the energy produced remains constant.

The electric generator converts magnetism into electricity, and nothing is growing in the generator, candle-flame, or in the electrolytic process.

Every organism (and all organic life) has an entropic spiral imparted, which begins to function when the conditions permit. This is the energy or force which weaves and builds an organism and is the origin force by which it functions and thus imparts and maintains life.

Now where do these entropic spirals come from in individual organic life of every form?

The central entropic spiral of the earth functions from and in the hydrogen glowing core, and this characteristic cyclic energy spiral is therefore already part of all organic life. In other words, the earth itself is a living entity out of which each organism is a unit product.

But to pursue this would lead us away from the Technique into the biological sphere; we are at present concerned only with the reversible process which is the mainspring of the production of power.

Nevertheless, there is one lesson to be learnt from the tree which will serve us in the new Technique.

The tree grows between two poles; the one sucks upwards and is, as it were, anchored in the oxygen stress-field and the other pole is anchored in the earth and draws

the hydrogen-oxygen energy (water), as building material, into the tree (ectopy). The tree grows only because this potential difference is present.

Now present physics declares that a tree pushes out oxygen into the atmosphere, but actually it is sucked out by the atmosphere (not the air) because, as we saw previously, the Ether is latent vacuum and exerts this suction when it is able to grip something which is likewise in the energy form.

We shall have other illustrations of this with heat and magnetism, later.

This also functions in the reversible process and becomes a fundamental principle for the functioning in the new Technique.

For the irreversible process to function, the whole energy structure of the tree must be available, and this of course exists as a complete energy entity or frame in the seed; but to bring this actually into being, the right conditions must obtain, *e.g.* the potential difference earth-atmosphere, always available; also heat, water, earth and air. The entropic spiral then forms and functions in the irreversible process.

We can reproduce the conditions necessary for the reversible process to function, by the new Technique, but the irreversible process is Nature's own prerogative, as is the entropic spiral and thus life itself. In other words, we can stimulate or promote growth, but we cannot reproduce it. We can bring about the conditions in which the life or conscious force, "biomagnetic force," is produced, but we cannot produce life.

On the other hand, the reversible process becomes the introduction to the new Technique.

We will now sum up the important points to be remembered:

Entropy is not in or by itself a force, it exists only when a potential difference is present, and when all the right conditions obtain.

It is the building force in Nature and functions either

- (a) as a reversible process; or
- (b) as an irreversible process.

(b) Here, it is responsible for growth in all its forms and in this form can only exist as a natural process, but its principle or system of functioning can be utilised in a new technique where

(a) the reversible process is reproduced artificially in the transformation and building of matter (energy-material) not outside but within itself, *e.g.* "an artificially produced sun," or glowing magnetism, within a suitably designed container, or Stator.

This enormous vacuum force functions between the PD earth-atmosphere and draws energy from the earth—H and O in energy form—catalyses it and transforms it into a powerful stressfield which can be utilised to produce mechanical power, whereas in the present technique the reverse of Nature's process is in operation—the electric current is earthed for discharge, not for suction. In other words, energy is returned to the earth, which is itself, for us who live on it, the greatest storehouse of energy in existence.

The correct way, therefore, must be that employed in the new Technique, *viz.* to draw from the earth as a storehouse of energy. We should not discharge the energy we have produced into the storehouse (the earth) itself, nor should we arrange our technique so that we insulate the actual source of energy from our generators, as we do at present. We should always draw from the source itself.

The functioning of the entropy spiral or entropy in the irreversible process, that is, in the growing of plants, trees and animalia, is not explained here. We are at present merely concerned with the physics or underlying principles on which the new Technique is based for the production of power in all its various forms.

Professor Brendt's Laws of Entropy, briefly stated, are:

- | | |
|---|--|
| (1) <i>Irreversible Process</i>
(product—material;
growth). | This promotes growth of
matter (as material)— <i>e.g.</i>
a tree, etc. |
| (2) <i>Reversible Process</i>
(product — energy,
and it remains
constant). | This produces and maintains
energy (as matter)— <i>e.g.</i> a
sun. |

In both processes Entropy is essentially a force which exists and functions only when a PD is present in energy form, and then it operates an energy cycle.

- (a) In the sun—PD, two likes in unlike condition.
- (b) In the electric current—PD, current, mobile; the cohesive force of wire, immobile; but entropic spiral distorted owing to space-form of wire; entropy or the entropic spiral here performs the function of producing the current and holding it to the wire, and giving it its motion of translation, because entropy is essentially—in either process—a spiral force exerting energy-pressure towards inwards—compression.

All true Entropy follows these basic laws.

Let us now examine the entropic spiral in the sun. If the sun's obliquity is too great it obviously cannot be reflected in a basin of water.

When it is visible, and it is not always visible, it appears rather like a circular cutter consisting of three or four curved blades spreading and disappearing into a centre. But we must not overlook the fact that on the flat surface of water this is an orthographic projection. In the sun itself the spiral is performing, from pole to pole, an involute-evolute then involute-evolute return as one cycle, but without reversal in sense. This has to be reproduced in the Technique in order to bring about the conditions for the Primary Force to generate.

A sun's spiral does not produce motion in a sun either of rotation or translation, directly; in the reversible cyclic process it merely maintains the energy-material as a "constant."

It is the product of alternating pressure and contra-pressure, which is suction, and may be diagrammatically expressed thus:

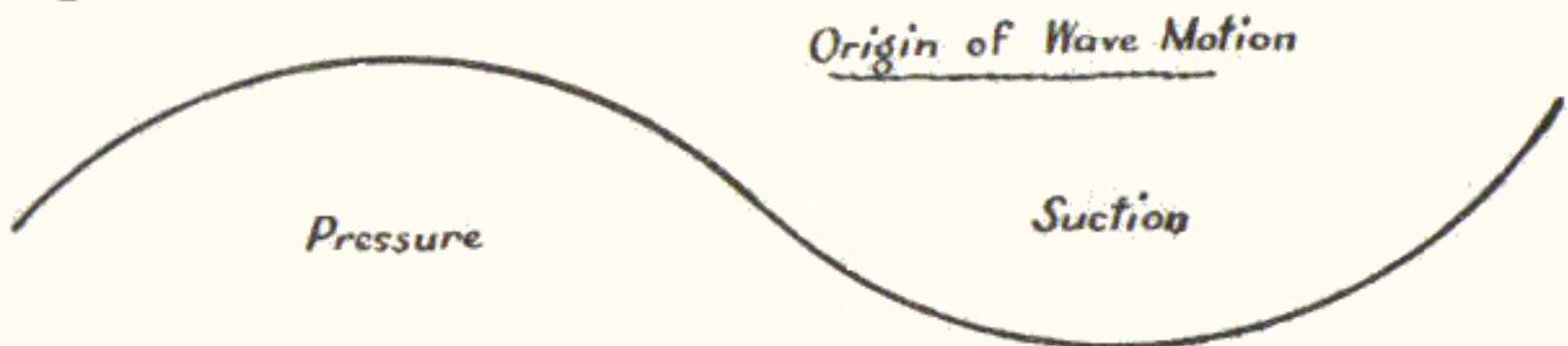

FIG. 6

the plus pressure outwards, the minus or suction pressure inwards.

In the sun this takes the form of a spiral, starting from one pole, increasing or expanding to the greater equatorial diameter—involute-pressure towards outwards from the sun's centre—followed by suction towards the other pole (evolute-pressure), and then the return as above explained. This is the origin of mobility, transpiration, energy-breathing, between the sun's core and its complementary stressfield.

If we drop a stone into a basin of water it will build a spiral energy wave, always decreasing in radius due to pressure and contra-pressure—outwards then inwards—action and reaction—pressure and suction—thus:

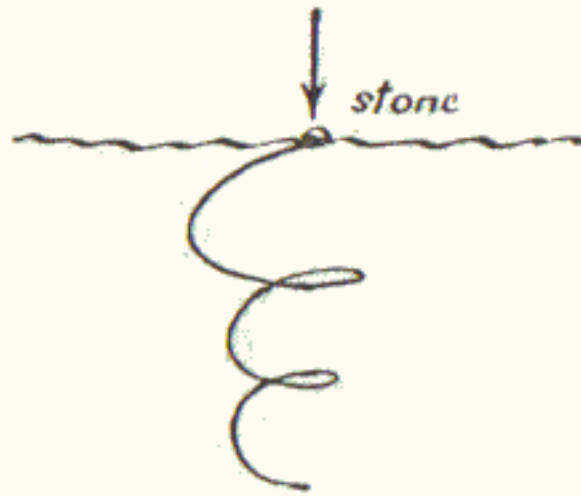

FIG. 7

The crossing of the stone through the cohesive force of the water furthermore produces air bubbles, and so it is in the cosmos, but in quite another condition—the energy-form.

The spiral there is formed due to the sudden appearance of a point of inequality in the Ether, occasioned by the disturbance of its homogeneity through magnetic heat concentration on a point in space (as previously explained) and followed immediately by a potential difference which results in the concentration into a core. This compression forms an "impression" or sphere of perhaps 100,000 kilometres in diameter and the reaction is expansion as radiation—pressure and contra-pressure or suction—and the spiral is formed, which gives rhythm or frequency to the Atomus, or central entity, the sun's core. It is likewise the origin of catalysation and feeding through mobility, maintaining

ENTROPY

the sun's mass approximately constant against the enormous loss in energy-matter due to radiation, and allowing possibly for a certain amount of mass-shrinkage as the sun's core gradually stabilises; the real shrinkage, however, takes place when the sun produces its first peripheral film, the initial stage of forming a crust.

CHAPTER XXIII

THE ELECTRIC CURRENT

What is the electric current?

Let us make an examination by applying our basic truth here, viz., that it can only be composed of that from which it was derived, although the form may be changed. Furthermore, it can only be derived from what was there and was available.

Now, we generate the electric current in so-called electric generators, and these generators are composed of nothing but steel and copper wires and certain accessories. We might say, therefore, that the electric current must be some composition of steel and copper, but this would be incorrect because the steel and the copper suffer no loss through the generation of the current.

No, the electric current is not another form of material, because if it were it could not travel through a solid body, such as a copper wire—it is energy and therefore must have been derived or transformed from some form of energy.

We must now examine the generator. This is composed of two parts, the one is stationary and the other moves—field and armature—or in an induction motor, stator and rotor.

There can be all sorts of varieties of electric generators and motors, continuous or direct current motors and generators wound in different ways for special purposes, *e.g.* series, shunt, compound, etc.; or, for alternating current, alternators of single phase or multi-phase; induction motors with rotating magnetic fields, synchronous and asynchronous motors, etc. But in any electric generator the absolute essential factor is the production of a magnetic field; what particular form this field takes is a detail as regards the production or utilisation of the electric current.

We must now carefully consider what this particular kind of magnetism is which plays the all-important part in electrical machinery of all kinds.

A scientist once said to the author: "Electricity first, then magnetism; no magnetism without the electric current."

This is obviously incorrect. The sides of a ship become magnetic merely due to riveting. So magnetism can apparently be produced by vibration alone—it can also be dispersed by vibration, de-magnetised. But there is only one known way of producing a powerful magnetic field in the Technique, and that is through the aid of the electric current itself.

There are ways of producing an electric current without a magnetic field, *e.g.* the primary battery, but there is no way of producing a magnetic field in a generator without an electric current.

Let us, in order to avoid confusion, consider first only an electric generator.

How do we produce a magnetic field? It is true we require the electric current to do this. We wind a wire round a steel core and pass a current through the wire and we produce, in the cylindrical space within the coiled wire or solenoid, what may be termed "magnetic evaporation" (ectopy) or a magnetic field which is absorbed by the cohesive force of the steel core and which cohesive force is itself magnetism, latent externally, but has the property of latent magnetism to absorb heat or magnetic evaporation, according to the conditions present.

An electric generator has such a field suitably wound to produce alternately N and S pole magnets in opposing diameters round the circle. If there are only two poles, then the N and S poles oppose one another across one diameter of the supposed circle, and if there are four, six or eight or more pairs of opposing poles they are set round the circumference of a circle, each opposing across a diameter; the whole, when a current is passed through the coils of the respective magnets, constituting the magnetic field of the generator.

We have already seen that electricity and the electric current are H and O energy and that magnetism is also H and O energy.

There is a law in the PP that the static can never produce the static, it must always produce the dynamic. In the central empty space inside the field of an electric generator we have a magnetic field which is static as a field (although there may be rotary stimulation as in the rotating magnetic field of an induction motor). The first consideration is whether this field is polarised, unpolarised or latent. It is unpolarised, but not latent; it is stimulated.

Here is, therefore, an important point, viz. that the field of a generator is unpolarised as such within itself, and polarised only as regards form, that is, as regards the setting of the poles. But place a piece of steel such as that used for a bar magnet, unmagnetised, into the empty centre of the generator's field, and the steel will instantly develop a N and S pole and a neutral centre. This is caused by the carbon in the steel. We saw previously that the ether is static carbon potential and in the secondary form the carbon forms the neutral and the ends of the piece of steel become the hydrogen and oxygen polar components; in other words, the carbon is the polariser, the magnetic field being absorbed and separated in the piece of steel into N and S poles, or oxygen and hydrogen poles, due to the vacuum force, that is, the cohesive suction force of the material. Although N and S are in a sense arbitrary—suffice it to say that in a bar magnet one pole is H and the other is O. (A compass needle does not actually point to the north or south, but lies along the isogonic line.)

If the space inside the field of an electric generator were polarised magnetism, the generator could not function at all, because it functions only by constantly cutting the magnetic lines of force which are themselves in interpolar but not mobile exchange. The H and O energy, or polar components of energy, between two poles in magnetism is blended—neutral, not mobile.

The ferro-magnetic substances are all mixed with iron or steel to produce a magnetisable material, but there is a

series of alloys—the so-called Heusler alloys—which do not contain any iron at all and yet exhibit strong ferro-magnetic properties. One of these alloys contains 16% Al, 24% Mn and 60% Cu. There is, therefore, no carbon to do the polarisation.

Now, the Ether is latent as carbon energy static, the two components being at rest or neutralised as magnetism but not functioning as cohesive force. When polarisation of the ether does take place, the components separate out and, in doing so, change to unlike conditions.

In a generator field the oxygen-hydrogen energy pull is equal and opposite between each pair of N and S poles as energy stress, but not mobility (energy exchange). There is no energy cycle operating because there is no catalyst and no entropic spiral since there are no two likes in unlike condition.

However, all cohesive force is H and O equalised out, magnetism but in a latent state; it does not therefore follow that because a certain substance has no carbon content, as such, that it cannot be magnetised. Cobalt and nickel can have their cohesive force or stressfield saturated through the carbon content in the steel to which they are alloyed, and in this case of non-carbon alloys specific proportions of a certain mixture of such alloys can bring about the right conditions for polarisation, because each of their cohesive forces is magnetism. And here it is interesting to note that the Heusler alloys are ternary—and magnetism is also ternary—two poles and a neutral, as we shall see later.

From the above statements we may, however, deduce the following conclusions:—

That since cohesive force of any substance is latent magnetism or the homogeneous equalised out stressfield of H and O, the two components of magnetism, all substances are capable of magnetism to a greater or lesser degree, and this accords with actual fact.

It may, however, be contended, since oxygen and hydrogen energy really constitute the components of magnetism when in polar form, that *kappa* * for these two

* *Kappa* = the susceptibility of the material.

should be greater than for any other substances and of opposing sign. The answer is very simple. In the energy form hydrogen and oxygen are magnetism, but in chemistry we deal with these two only as substances in the gaseous form, there, *kappa* values being per c.c., whereas for solids the unit is the gram.

The figures could not therefore be directly comparable, owing to the different states of the substances, the gaseous being quite different from that of the liquid or solid. Nevertheless, even here, there are interesting facts to be noted. Oxygen is by far the highest value of *kappa* and positive with 139×10^{-9} , whereas hydrogen is -0.164 and nitrogen only 0.49 , both negative, even as gases.

It is, however, obvious that outside the energy form, *i.e.* in the gaseous, liquid and solid forms, other factors determine the magnetic susceptibility of a substance. In other words, H and O are only true polar components of magnetism as regards their energies. Furthermore, although the atmospheric stressfield is H and O in energy form, but latent, its sublimate air in gaseous form is no longer polar and the hydrogen is transformed into a neutral state, *viz.* nitrogen with its residue, the noble gases—one of the permutations of which we spoke previously.

The actual magnetic properties of solid materials depend on such factors as their history, state of strain, temperature, grain size and perfection of crystals—the last of which is the direct result of a magnetic field.

Carbon energy, on the other hand, is itself equalised out magnetic potential, and in a metal the static energy functions as a polariser. When a magnetic field is absorbed by steel or iron the carbon energy in the metal separates the two constituents of magnetism, *viz.* H and O, into two poles, the central portion being the carbon neutral. Or, as has been explained in the Heusler series, the same condition is brought about by a specific proportion of a ternary alloy.

The essential condition is that every magnet must consist of three parts—two poles and a neutral.

Now let us return to our generator field. Here we have

built up a field of alternate N and S electromagnets or poles round a circumference.

In this case where are the three essential conditions—the two poles and the neutral? Each electromagnet has only one pole. Within itself, yes, but as regards “form” or the field as a whole, the essential conditions are present. The magnets are set as regards “form” in opposing pairs N and S, plus and minus, or whatever notation makes it clear, and the neutral is the central core of air space, or neutralised interpolar energy. And this neutrality or impolarity is the real source of the electric current.

So far we have, however, only magnetism, and in order to obtain an electric current we now require an electrolyte. An electrolyte, as we shall see later, is perhaps best described as an agitator.

There are various forms of electrolytes:

- (a) dry electrolyte—the ether,
- (b) wet electrolyte—chemical (galvanic),
- (c) thermo-electrolyte.

But none of these are suitable for an electric generator. We must now remember the other law we established, viz. no force can be produced or transformed except by the crossing of two stressfields.

We have in the central space a static stressfield of stimulated but impolar magnetism, and in order that this should be crossed, we require not only another stressfield but motion. Therefore our electrolyte or “agitator” must be a core, suitably wound with copper wires and capable of rotation. This is termed an armature or in AC motors a rotor—an “electrolyte capable of rotation.”

We now require one other essential for the production of the current, a complete circuit (copper is the most suitable material) and a suitable resistance in the circuit to utilise the current produced, and also all the accessories to control the current—this, however, is technique and has nothing to do with the principle. But these are the conditions under which an electric current is produced.

There are, therefore, three pieces of apparatus necessary for the production of an electric current:

- (a) a magnetic field,
- (b) a rotary electrolyte,
- (c) a circuit (of copper wire).

These are the essential component parts of every electric generator, or the reverse, a motor.

(a) This is obviously the only source of the electric current; nothing else is available from which to produce it. *Therefore the electric current is magnetism.*

(b) This is the essential to produce it—the magnetism from the field is induced into the wires on the armature, through primary compression, *i.e.* energy compression, not compression of the metal of the wires but compression of the cohesive force of the wires occasioned by the crossing of two stressfields suitably arranged. *Therefore the electric current is compressed magnetism.*

(c) The rotary motion of the armature continuously increases the pressure of the compressed magnetism in the wires and circuit. *So the electric current is highly potentised compressed magnetism.*

In other words, an electric generator is nothing more than a “magnetic mill.” The magnetism is milled up, compressed and potentised, and the function of the wire in an electric circuit is really to compress the magnetism and thereby produce the current. It is impossible to produce an electric current without wires.

But we can produce an electric current without a mechanical generator. A so-called galvanic or primary battery will produce a current. Here we merely have two plates of suitable material, and an electrolyte.

Let us take what is known as a Leclanché Cell. This consists of a zinc rod which dips into a liquid electrolyte, ammonium chloride. The other electrode or plate—a carbon rod—is surrounded by a cup filled with powdered manganese dioxide, and is called a depolariser, its purpose being to react chemically with the hydrogen which accumulates

and to produce water vapour. Graphite is also added to increase the conductivity still further, and there must, of course, also be a closed copper circuit.

We have here exactly the same essentials for the production of the current as in an electric generator or motor, but in quite a different form.

From what is the electric current derived in this case?

It will not function without the wire circuit, the electrolyte or the plates. We saw that the function of the wire is to compress the magnetism into an electric current, and that the electrolyte is simply an agitator, whether the electrolyte is dry, wet or rotary. Here it must be wet because chemical action is required.

The magnetism, the source of all electric current, cannot therefore be either in the wire circuit or in the electrolyte, because the former compresses the magnetism when it is there and the electrolyte "agitates." But what does it agitate? The plates or poles. Then the magnetism must be in the poles. Where in the poles? The cohesive force of all material is H and O equalised-out stressfield or impolar magnetism. This is the source of power from a primary battery. Two plates are chosen in the series differing widely in density and thus in cohesive force—herein lies the potential difference.

The electrolyte merely agitates the surface of the softer plate, and the cohesive force of this plate, in this case the zinc, supplies the source of magnetism and therefore disintegrates.

This energy attached to matter (or ions) is carried across to the opposite plate, and the energy (only) passes up the other and harder plate, in this case the carbon plate, drawn up by the vacuum force which the wire exerts through its cohesive force on the larger area of the plate; once again we have the crossing of two stressfields, the stressfield of the energy given up by the ions crossing the cohesive force of the carbon pole, finally being compressed into current by the wire. The potentiating takes place through the continuous supply of energy from the ionic charges.

It will be noted what an important part carbon plays

in this cell. One rod is carbon, what might be termed the "elemental" of magnetism, graphite being added to increase the conductivity of the electrolyte because carbon is itself composed of the two components of magnetism. This is why carbon also conducts the electric current as in carbon electrodes and brushes.

Storage cells or accumulators need not be dealt with here because in these it is only a question of holding a charge, not of producing one, but the principle is the same whether an acid or alkali electrolyte is employed; the density, or cohesive force, of the two plates is in this case very nearly equal, as only a very small potential difference is required, because the cell is only for storage and not for generation of current.

We may, therefore, sum up: magnetism is basic in the free state in the all-pervading ether, but latent; in the bound state as cohesive force in material, *i.e.* as an equalised-out stressfield, also externally latent, constricted to its Space-form.

No electric current without magnetism. No electric current without the crossing of two stressfields. Every current generator is a magnetic mill; it either releases the magnetism as cohesive force, as in a primary battery, by disintegration, or mills it up from an impolar stressfield, compresses and potentises it in a wire, as in an electric generator.

So the electric current is an energy or force, this force is out of an impolarised field and is compressed to current through induction in a wire. Induction is the penetration of force or energy into matter (as material).

Electricity is thus a specific form of stress or stressfield derived from magnetism; heat and light are other forms. All these are interchangeable when the right conditions are present, as shown by the Nernst effect, etc.

But the dynamic can never produce the dynamic, it must always produce the static, and so the electric current which originated from an impolar static field—but now dynamic by virtue of its motion—must itself produce the static and it does.

This is the origin, of course, of the BEMF* and the ether-pull on this energy produces the magnetic field which exists round every wire through which a current is passing.

In the circuit it is the source of the resistance which the wire offers to the current, whereas in an electrical machine, in the armature, for example, it functions as a BEMF. If the electric current were not magnetism, it could not produce magnetism as it does here in a magnetic field round the wire and also in an electromagnet by virtually the reverse process of absorption from a solenoid. Here the resistance is not a BEMF but is occasioned by the cohesive force of the steel core of the magnet. To make this clear we only term it a BEMF in a motor but BEMF or any other form of resistance in a circuit is resistance, the BEMF functioning in a specific manner.

The electric current is therefore a compressive force which in principle is produced by the cohesive force of the wire—the internal energy pressure of the wire, *i.e.* the cohesive force, functioning compressively towards the centre of the wire, maintaining the form of the wire and simultaneously compressing the “milled magnetism” to “electric current.”

The electric current also owes its existence to entropic action. The entropic spiral, as we have seen, functions by exerting a force towards inwards, and it is this that makes the electric current a compressive force and holds it to a wire. (Entropy is a spiral force exerting a pressure inwards.)

There is, as has already been stated, no entropy spiral between the electrodes of an electric circuit as such; but there is an entropic spiral within the current itself because the current is the product of a potential difference and of fire, water, earth and air, as we shall see shortly, the essentials previously given for the production of an entropic spiral, the current itself being magnetism and magnetism being the force out of Space or the Ether, a vacuum force, and true vacuum always acts as compression inwards.

When it is a spherical vacuum the entropic spiral takes

* BEMF = Back (*i.e.* reversed) Electromotive Force.

its true form and produces biomagnetism, but here in a wire it is distorted, elongated, owing to the space-form of the wire.

Furthermore, if electricity were not a vacuum force it could not pass through a solid body. If it were not a compressive force it could not be carried by a wire. Steam is an expansive force and requires a pipe. When we pass a current through a wire, the current being a compressive force still further compresses the cohesive force of the wire; both stresses are of like sense, towards the centre. If we over-compress the cohesive force by too strong a current for the cross-section of the wire, the wire disintegrates, or melts. Here we have again the crossing of two stressfields producing another form of energy—stress of the electric current crossing the like stress of the cohesive force of the wire—once again energy compression, and through the crossing of these two stressfields another form of energy is produced, heat. If now we arrange that this heat is produced under conditions in which the wire will not melt, such as those existing in a lamp filament, we produce yet another form of energy known as light.

So electricity, or the electric current, is a single compression always producing heat (in a generator c^2r losses), and light in an incandescent lamp is a “double compression,” in the present electrotechnique—first, compression in a wire, producing the electric current, then compression in a suitable filament producing heat and light.

Since the electric current is force or energy out of magnetism and magnetism is derived from the ether of space, we may say in principle that the electric current is energy out of Space. This has no significance in the present electrotechnique for the engineer, but the physicist should grasp it because, presumably, it is his particular business to study origin and cause in order to discover and be able to utilise the Primary Force, and, as has just been explained, to establish the origin of the electric current and the reason that it also has “compression” as its principal characteristic.

The electric current is thus compressed potentised ether and its source is always the polar impolarity. In the case of the generator the field source was polar in form, producing an impolar field, and in the primary battery we saw that it was the same in principle, but with an entirely different setting.

Interpreting this in the terminology of present advanced physics, we have—

First the fundamental formula

- (1) $F = ma$
- (2) $F_L = iHl$ (electromagnetic system)
- (3) $i = Nnev$ (electrostatic system).

Now substituting (3) into (2) and inserting the conversion factor between the two systems we have:

$$F_L = NnevHl/c$$

This is the amount of the force on length L of a wire containing NL of the charge-bearing particle.

In other words, this is virtually the fundamental formula for the electric current in a wire where

- F_L = the force on any length of wire L
- i = the current
- H = strength of field

force being at right angles both to current and field.

The field is that produced in the wire by the passage of the current.

Interpreting the current in a wire as a stream of particles of charge ne of which there are N per unit length of wire, all of them advancing with a speed v , the amount of charge passing any cross-section of the wire per unit time, which quantity is actually the current, is given thus:

$$i = Nnev \quad (e = \text{Millikan's constant})$$

The development of this brings us to the principle of the cyclotron, with which we are not concerned at present.

Suffice it to say here that the electric current is

virtually milled-up cohering particles on which the above formula is really based.

But we must examine more deeply into the nature and functioning of the electric current.

Let us recapitulate that the origin or source of the electric current is the polar impolarity. It is ether-vacuum, atonic not atomic. Conceived as atoms, in the electric current they are not in their fullness but as it were torn or crippled—this is important—thus the distortion of the entropic spiral.

The electric current is an impolar magnetism which, due always to its impolar origin, is itself a source of all polarised magnetism.

A wire conducts a current because the ether or cohesive force of the wire is likewise magnetism and thus has an affinity for the electric current. It may also, broadly speaking, be regarded as “steel magnetism” since it owes its origin to the magnetic field of the generator.

The two opposing fields of force, that is, the pairs of N and S pole stresses, are induced into the armature; this is why the electric current is unpolarised stimulated magnetism, because in it the polarity is equalised out.

The centripetal cohesive force of the wire gives this milled-up impolar magnetism coherence, as a continuous stream or current—hence the formula given above.

So the current generated in a dynamo is a sublimate out of magnetism, out of an impolar magnetic field.

Magnetism is compressed in a wire to current, and the current then produces a magnetic field again—action, reaction, and action again.

In steel it occasions polarised magnetism, the carbon energy in the steel functioning as polariser, but in copper—copper-wire—it produces an impolar field, and this field is the product of the tremendous centripetal pressure to which the current subjects the cohesive force of the wire by acting inwards—the reaction being an expansive stress-field which must be a magnetic stressfield because the electric current is itself magnetism. This is the origin of the magnetic field round the wire carrying the current.

Speed of the electric current.

Now the electric current is credited with tremendous velocity, viz. 300,000 kilometres per sec. So the electric current is dynamic and we said it must be, because the field from which it came is static and the static always produces the dynamic and the dynamic the static. Nevertheless, the electric current is not dynamic but static. The true scientist or physicist must never take things for granted. For the engineer, so long as he keeps to the present technique based on the present laws of the physics of the secondary states of matter, this fact has no significance.

The electric current, as such, is static, it does not move, but it is moved; in other words, the dynamic or motion is produced by two likes in unlike condition—the cohesive force of the wire which is H and O energy as homogeneous stress, and the electric current which is H and O energy but mobile—one must move.

The cohesive force of the wire is inevitably bound to the material but the current is free “to be moved.” Therefore, although the electric current is not dynamic in itself, the dynamic is produced as motion in that it is moved.

The electric current is a source of enormous power but only when the right technique is applied. The power which it possesses lies in its stupendous velocity. The origin of this velocity is the two likes in unlike condition, having an affinity for one another, that is the cohesive force of wire and the cohesive force of the current—and we said that the current is ether-vacuum, and so of course is the ether itself, but latent as such.

But to make the motion of the electric current clearer it should be explained that the “two likes in unlike condition” causing the sun’s motion of translation are quite different from the two likes in unlike condition which cause the electric current to move.

In the sun we had complete mobility between it and its surrounding stressfield—energy transference or interaction—because both are energy in a free state. Here, on the other hand, we have only one, the electric current, in

the mobile condition, the cohesive force of the wire being static, latent and bound.

It is obvious that even although the same law holds, because it is a primary law, in the Technique it must function in a different way, and it does.

We have seen that the electric current is a compression force, if it were not it could not be carried in a wire, and also for the more basic fact that it arises out of magnetism, which in its turn originates in the ether, and the ether has the *characteristic* of centripetal compression within itself.

Thus the superimposition of this compression force, or electric current, upon the cohesive force (of like kind but static) of the wire, exerts upon the energy frame of the wire a compression which forces the current to move forward—the compression originating from entropy.

Now, suppose we could generate the electric current and then stop its speed until it became static, but preserving of course the two likes in unlike condition; the “electric current” in its new form—the static condition—would still retain its enormous force, but would manifest it now in a static manner; in other words, as a stressfield. Herein lies the secret of the new Technique and the production and utilisation of the Primary Force, as we shall see later, viz. the production not of the electric current, but of what, in principle only, might be termed its static counterpart, glowing magnetism.

Here we have the atomic and not atonic force—here the atoms, *if we must use this terminology*, are in their full stature; here no wires are required. Here no resistance exists. The BEMF is lifted and becomes the surrounding oxygen stressfield; here there is no velocity or speed. But nevertheless mechanical power could be produced in this new generator, which comprises a Stator and Rotor, the two being entirely separate but reacting upon one another, the Rotor being similarly stimulated to the glowing magnetism in the Stator. The Stator is the first real electric generator; it generates free electromagnetism not bound to wires or metal.

Here again the static produces the dynamic. The crossing of the Rotor stressfield with the stressfield of the Stator produces rotary motion in the Rotor—the basic cause of the sun's motion, but under different conditions.

There are no moving parts whatever, the Rotor being placed directly on the shaft to be driven.

The principle is mentioned here, but the whole Technique has to be studied to understand how this might be carried out in actual practice.

The electric current has two characteristics—the power to dissolve materials and the power to concentrate them as in electrolysis. It can bring metal to the molten state, and it can concentrate or build up energy-matter when the right conditions are present, *e.g.* in an incandescent lamp. Light-matter is here built up through double compression.

This light is not, as present Physics believes, the result of molecular vibrations in the wire, but of molecular vibrations in the current.

Experiments in Physics have shown that the intensity of light from any artificial source is proportional to the heat generated; it is from this co-incidence which so often occurs in experimental physics that the above origin-error originates, and we are dealing here with "origins."

It is possible to make an object and its shadow move uniformly, that is, without relative motion. Nevertheless, to deduce the movements or nature of the substance from a temporary coinciding shadow is very misleading when examining origins. The ultra-cause of the coincidental movement of an object and its shadow must first be known before reliable deductions can be made. Furthermore, in present Physics (SP) the established laws are only valid within certain limits, *because they have to function through the technique.*

High temperatures can be measured with accuracy either by pyrometers of the Total Radiation Class functioning on Stefan's law or those of the Optical Class functioning on Wien's formula, comparing brightness or intensity of light with temperature.

Wien's well-known formula is

$$E_{\lambda} = C_1 \lambda^{-5} \times e^{-C_2/\lambda v}$$

Both these formulæ, Stefan's Fourth-Power law and Wien's, agree within certain limits of temperature very closely, Stefan's using Total Radiation throughout the range of wave-lengths, and Wien's, as can be seen from the formula, using monochromatic light with a small tolerance of 200 AU (0.02 μ).

But returning to cause and origin, we must consider the discovery of Prof. Richthoven, of Prussia. He declared that by experiment he had proved that the electric current is oxygen and hydrogen energy. This, it will be observed, coincides with the discovery in the PP, which has already been elaborated.

Richthoven proved that the electric current is H and O and that, when great heat through resistance is evolved, these energies are converted into what present Physics would probably term "electronic gases"—hence, he says, the "high lumen" value attainable.

Heat the same tungsten filament in an electric radiation furnace to the same temperature and the same lumen value will not be reached, so he explained.

However, no electric radiation furnace can at present attain the temperature registered by an Optical Pyrometer on an electric incandescent lamp filament—about 2600° C.—measured by this pyrometer functioning on Wien's formula, although this temperature will not be even then the real internal temperature produced in the filament. It will only be the corresponding figure as it might be termed on the "light scale," read in temperature degrees.

Small electric furnaces in laboratories use nichrome wire suitably wound and arranged, and a temperature up to 1800° C. is obtained. But in carbon arc furnaces over 3000° C. has been reached. Exactly so, here we have H and O from the current, and the "elemental" carbon.

In the oxy-hydrogen flame we have again oxygen and hydrogen energy but in the gaseous form.

In the oxy-acetylene flame we have oxygen and C_2H_2 —carbon (“the elemental”) and hydrogen.

Richthoven’s experiments mean that, for example, a tungsten filament lamp derives its high lumen value not merely directly in proportion to the heat generated, but because the electric current is functioning as an oxy-hydrogen flame but in energy form—electronic gas, *i.e.* without the gaseous clothing. The high lumen value thus arises not entirely from molecular vibrations in the current but from the conversion of the heat energy into an electronic gas.

Now when we consider gas illumination—the chief illuminant of coal gas is olefiant gas and other associated hydrocarbons of the C_nH_{2n} type, which in all amount to only about 5 per cent. of the composition of the coal gas as such.

The highest temperature constituents of coal gas do not give the highest luminosity.

A catalyst has been devised known as the gas mantle, which at its lowest efficiency gives 15 times the illuminating value of that obtainable from any given quantity of gas stripped of luminous hydrocarbons.

A gas mantle thus changes or catalyses the gas into a form of latent electronic-gas, through energy compression—that is, through the cohesive force of the thoria-seria mantle bringing the gaseous energy, also in the glowing state, to glowing energy, just as the cohesive force of the tungsten filament brought the electric current through energy compression to the glowing energy state.

The energy here is supplied in gaseous form as coal gas minus the luminous hydrocarbons, but of course still requiring air—owing to the supply of energy being in gaseous form.

Great heat is produced in the mantle and this heat stress crossing the cohesive force or stress of the mantle changes or catalyses the gas by energy compression (overfilling the cohesive force when melting and disintegration cannot take place) into the energy or glowing energy condition, producing a great quantity or intensity of light-matter—which, as we saw, is a product of energy compression.

The greatest heat with coal gas is produced by perfect combustion, as in the Bunsen burner, of very low luminosity. A much higher lumen value and lower temperature is obtained with imperfect combustion in a fish-tail burner.

The production of high luminosity accompanied by high temperatures is thus caused by glowing energy, due in each case to the particular form and arrangement—whether a gas flame or through the medium of the electric current.

So the formulæ, *i.e.* Wien's and Stefan's, indicate what the temperature of a filament would be on the temperature scale, but not what it actually is in the filament, as the internal temperature of the filament is as immeasurable as the internal temperature of a piece of glowing steel in a fire.

As a matter of fact, Stefan's Fourth-Power law or Total Radiation Pyrometer cannot be used here at all, as it is intended for black body radiation.

The electric current is thus oxygen-hydrogen energy and when a suitable resistance or catalyst is supplied it functions as an oxy-hydrogen flame but in energy form—without the gaseous clothing—producing great heat and, through overfilling the cohesive force of the filament, great luminosity as glowing energy due to the molecular vibrations, not of the wire but of the current.

But, returning now to the electric current itself—if the “wire” were mobile, that is, free energy dynamic, then the current would become static, or it would cease to be a current. In other words, if the current-carrying wire or conductor were in a mobile or dynamic condition it would bind or hold the current. We should then have the static force—glowing magnetism—the great static electromagnetic force for which Science has been waiting, the Primary Force.

The electric current is static as such, because it is derived from the static magnetic field, and it is *movable*—but not mobile—so the dynamic has been produced in it, but as motion and not as mobility.

The wire or conductor really stands in the way of the current, which it nevertheless produces, because without

a wire conductor no electric current is possible. Hence the resistance. In the Schappeller Stator the resistance functions as a complementary stressfield producing the true atomic force, the present electric current being thus atonic.

Static mobile magnetism produces dynamagnetism when the proper conductor or catalyst is present, that is, when "the wire is mobile," and it is then, of course, *energy and not a wire*.

As we shall see in the new Technique, here it is the electricity that is static and the magnetism that moves, hence the term dynamagnetism, and the BEMF is no longer a resistance but is transformed into being the complementary "other half" of the vacuum force—the surrounding oxygen stressfield.

Now the law in mechanics is that "work" is "force times distance travelled," *e.g.* a force of 10 lbs. through a distance of 10 ft. equals 100 ft. lbs. of work. In the electric current the force is the current potential or stress, and the distance or path is the stressfield developed by the current in the wire. The current is energy and can only travel on energy, that is, on the stressfield of the wire, from the cohesive force of which it derives its motion and in fact its existence.

The velocity imparted to the electric current is produced between the stress in the wire and the stress in the current, which constitutes virtually a PD; it is composed of the static vacuum force of the wire and the vacuum force of the current, but in unlike condition, producing motion; the PD arising from two likes in unlike condition, *one must move*.

The electric current has virtually all the four natural elements in it, Fire, Water, Earth, and Air or atmosphere.

FIRE in that it has the heat of compression in it and can be brought to the glowing state.

WATER in that it flows and consists of H and O.

EARTH in that it possesses the gravitational force, or rather, brought to the static glowing condition, it is the gravitational force.

AIR in that it can separate water into its gaseous constituents and itself takes on a gaseous state (spark or flash).

In the electric current volts are Ether-vacuum. Ampères are compressed or densified volts or densified ether, *i.e.* Vacuum-ether—ether materialised in vacuum, that is, energy-material or glowing magnetism.

One h.p. in electrical units equals 746 watts. Any multiple of this can be volts or densified volts or amps., and we still have 1 h.p., the technical limit here being the least pressure or voltage which will enable the maximum amps. to be conducted through a given resistance. Amps. are therefore nothing but densified or compressed volt-stress, and ohms are the resistance offered by the cohesive force or suction on the energy-frame of the conductor.

The fundamental formula here is Ohm's law:

$$C = \frac{E}{R} \text{ for CC}$$

its extension is . . . virt. $C = \frac{\text{virt. } E}{\text{impedance}} \text{ for AC}$

and for the new Primary Force it will take the form of

$$C = \frac{\text{gaussfield (Vacuum)}}{0}$$

C here no longer represents electric current but its equivalent in static form as densified volts, *i.e.* amps. Since the BEMF is lifted and functions now as the other complementary half of the vacuum, there is no resistance and C therefore equals infinity. The resulting force is an electromagnetic emanation or stimulated stressfield—dynamagnetism. The full meaning of the principle expressed in this formula will be seen in the new Technique. (See Part II.)

Why is the dynamo cold? Because the magnetism is cold. Why is the magnetism cold? Because it is expansive. Make the magnetism compressive by implosion and you then have a real electric generator which produces and

maintains electricity (electromagnetism), the electricity being static and the magnetism being radiated in the form of a stressfield.

Electricity is merely heat and cold stress. H is the heat stress; when free it compresses to glowing magnetism. O, the complementary stress, is cold and expansive in the free or primary state, but complementary as atomic force or vacuum.

Carbon energy static contains both within itself, but there is no manifestation of this until it is polarised into its two components, H and O.

Hydrogen is thus the product of a heat stress and oxygen the product of a cold stress.

Every form of stressfield can be transformed into electricity. The proof of this is the Peltier, Thompson, Nernst, Ettinghaus, Hall, Ludec effects—all these are transformations either from or to electrical energy through the crossing of the stressfields.

The Primary Force manifests itself in various ways in the secondary forces but it is then controlled by the various techniques (through apparatus), in heat and cold, electricity, electric current, magnetism, or as steam, or in water as cohesive force, and likewise as cohesive force in materials, but it all arises from the static potential of the Ether—for Nature is one unity.

The electric current is thus fire or water, according to the manner in which it is formed, or it is the third condition of water, because water is H and O energy. Polarise the electric current itself and we have H and O energy as separate complementary poles, and this is another basic principle of the new Technique, to produce, virtually, polarised instead of liquid water—spherical energy, magnetism or vacuum instead of latent liquid magnetism.

The constituents are in each case one and the same, H and O energy.

The electric current, produced as at present in a wire, is compressed magnetism. Compressed magnetism, or current, produces "light-matter"—that is through a double compression in a wire, this wire being termed a

filament. If this were attempted in one compression the wire would melt.

The electric current is compressed potentised ether or atmosphere.

In the electric current:

The current	.	.	.	is moved
The wire	.	.	.	is static
The stressfield	.	.	.	is in oscillation

In present generators the electric current is a sublimate or precipitate of magnetism.

If a body is subjected to a stress an electric current is produced, which, provided the right conditions obtain, is measurable.

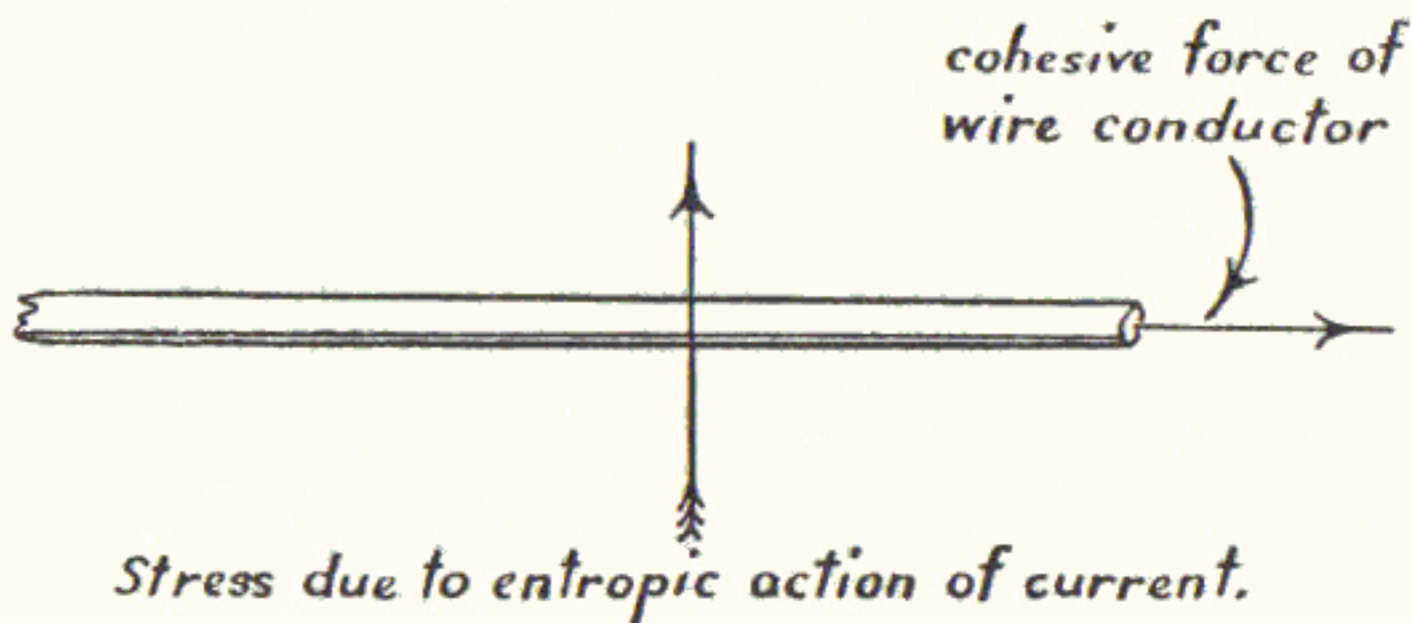

Product - electric current.

FIG. 8

Likewise the various "effects," previously given. See also "Blausen experiments." (Appendix.)

SUMMARY

The electric current is potentised ether or atmosphere. It is a specific form of the energies. Energy builds matter, and likewise material, when it can.

The electric current builds matter when an entity is available, e.g. the incandescent lamp—here, ionisation through heat produces the glowing state or light-matter.

It also builds matter in electrolysis, but by a different process. Ionisation is the transformation of force or energy into matter (as energy).

The electric current is vacuum; ether-vacuum, it is sucked and has the power of suction. An incandescent lamp, for example, draws or sucks through the action of the cohesive force of the filament (latent vacuum force) the exact amount of current according to its capacity, or it densifies to amperes according to its capacity—its capacity is, of course, dependent upon the specific cohesive force and sectional area of the filament material. If the volts are too high, then the cohesive force is overpowered; if the volts are too low, then the suction force (cohesive force) cannot grip the mobile stress or current.

Finally, the amps., or densified mobile stress, are brought to the glowing state and heat and then light-matter are produced as an oxy-hydrogen flame but in the static energy form, not as a gas.

It is material that dominates, not energy. Energy alone cannot function—it must operate upon something, either on matter as energy or as material.

On the other hand, in electrolysis the electric current draws or sucks or binds together, as has been explained.

In other words, it sucks and is sucked because it is itself a vacuum force. But vacuum force is not necessarily electric current. Glowing magnetism is true vacuum force, *i.e.* vacuum-ether; it is also densified amps., but not as current, it is electromagnetic energy, but mobile static.

As has previously been explained by a diagram, the central glowing core is vacuum-ether; the complementary surrounding oxygen stressfield is ether-vacuum; thus the functioning of the one on the other *in the core* is ether-vacuum on vacuum-ether. This is termed "Indication," not given in the list of definitions.

Where there is "Indication" there is definitely induction, but where there is induction there is not necessarily Indication.

In fact, to make this clear, "Indication" is perhaps best defined as the result or functioning of "mobile

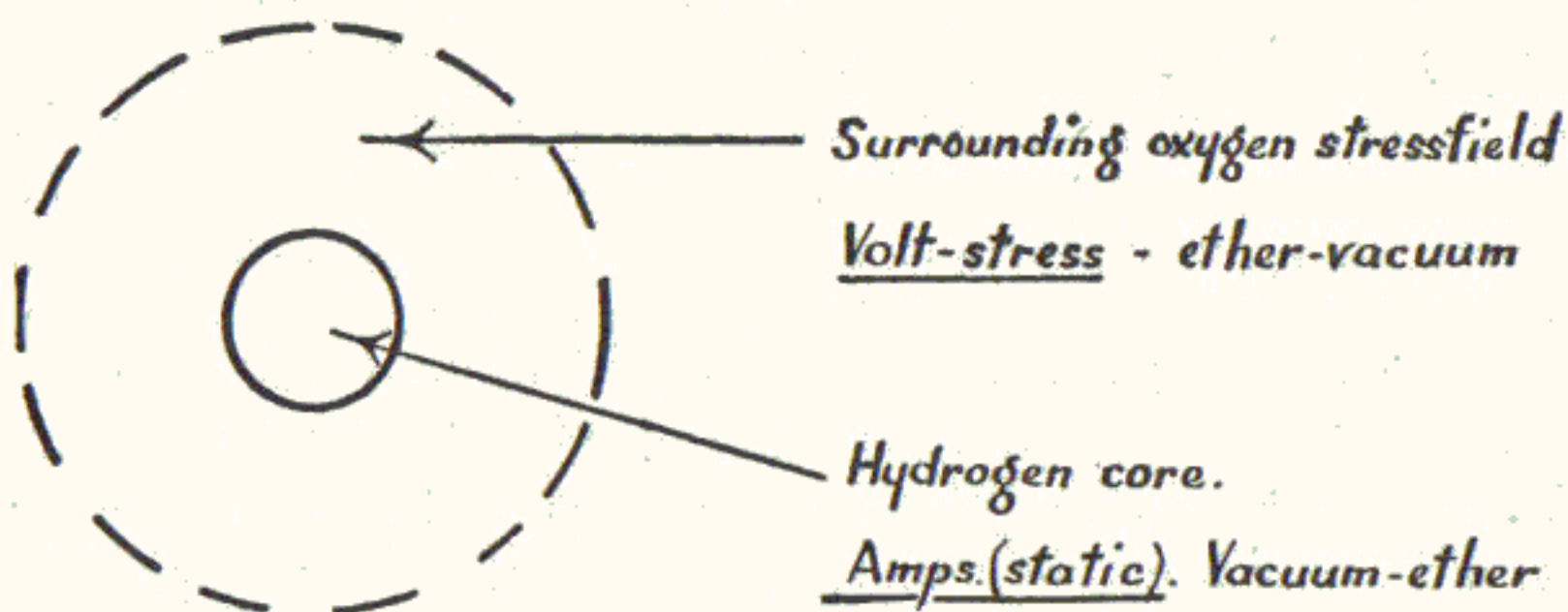

FIG. 9

induction"; just as "impression" is the form built by implosion.

Impression relates to the space-form or physical centre and Indication to its functioning.

The electric current is the product of two like stresses; the one, being mobile, must be set in motion when the other is in the static condition. Mobile here means "stimulated or in oscillation."

- | | |
|---------------------------------------|---------|
| (a) Cohesive force of wire | static. |
| (b) Current stressfield | mobile. |
| (c) Current moves (is moved). | |

The electric current is the product of adhesive force, not cohesive force, but it has the characteristic of "cohesion" in it. Ether-vacuum is adhesive force with the characteristic of cohesive force. Vacuum-ether (glowing magnetism) is cohesive force proper.

Cohesive force exists only in matter, *i.e.* as energy in material or in the materials. It is the so-called atomic force, but latent and bound.

If a body is subjected to a stress under the right conditions an electric current is formed.

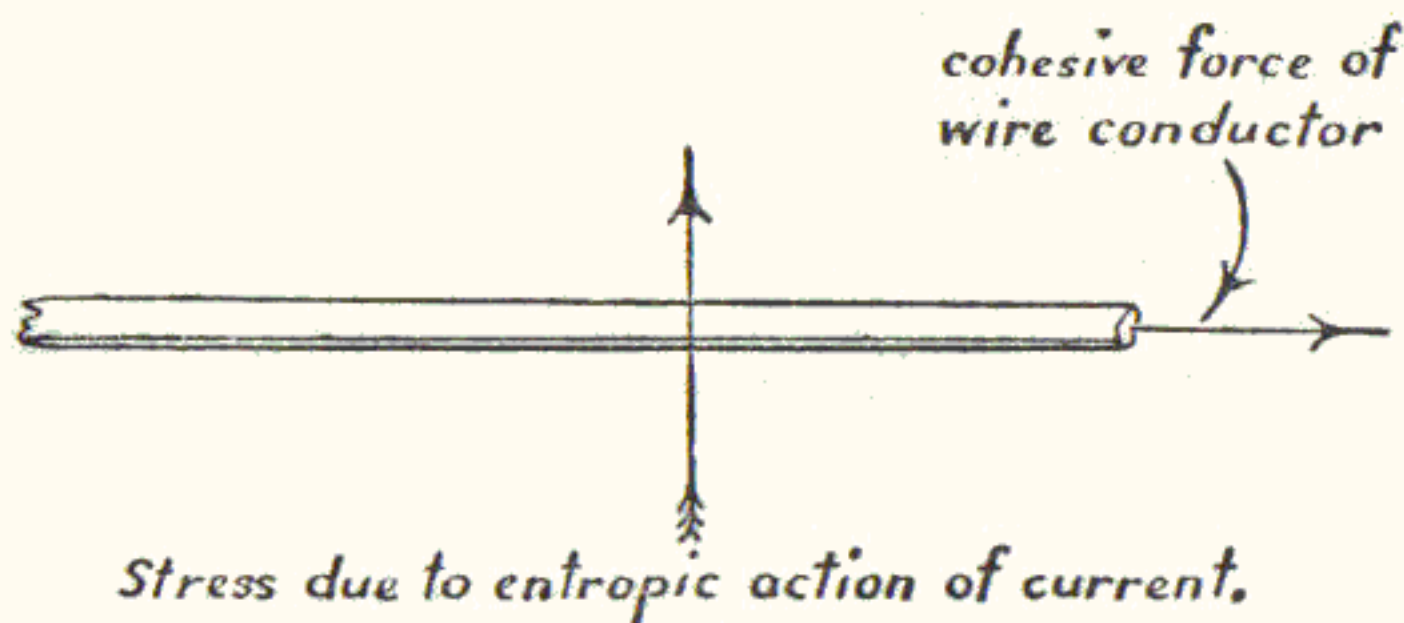

Product - electric current.

FIG. 10

Likewise the various "effects," previously given. See also "Blausen experiments." (Appendix (6).)

Vacuum (secondary) is stress without matter, the equivalent in the electric current of, say, a wattless current, therefore no electric current, merely a volt-stress. This is purely illustrative.

Vacuum (primary) in the new Stator possesses both stress (mobile) and matter (energy-material), therefore the electric current as such can be produced if and when required, once again, by the crossing of two stressfields.

The electric current from a primary battery obtains its atomic or vacuum force through the disintegration of the cohesive force of the plate or electrode, but in the current produced it is atonic, not atomic—this has, however, the atomic or cohesive force as a characteristic within itself.

The electric current does not "bind," it is bound or held concentrically but not longitudinally. That is why it must move, and since it moves it is atonic, adhesive, incomplete, occasioning distorted entropic functioning.

Immobile conductive circuit (wire conductor) brings force to dynamic as motion, and thus immobility—result, a devitalised current known as the electric current.

Mobile conductive circuit (energy-material) brings force to static or zero motion, but dynamic in functioning and thus "mobility"—result, a stressfield, biomagnetic excentric from

a physical centre of emanation, known as biomagnetic, static, electromagnetic vacuum force, resulting in dynamagnetism.

The Law: Electric current in motion produces static magnetism in metal, bound, unpolarised within itself as magnetism, polarised only as regards form in the metal—requiring opposing poles to function.

But *static magnetism with a mobile circuit* produces dynamagnetism as a mobile stress-field.

Work is force times distance or path. In the electric current “the path” here is the stimulation of the cohesive force of the wire—the force is the stress in the current. Energy or force can only travel or operate on energy. In other words, a copper wire as such does not and cannot conduct a current—it is the energy, cohesive force, of the wire that conducts the current, which current owes its existence to it and to its own entropic action. The “matter” in the current has as much force as the resistance it sets up either as a BEMF in an armature or as ohmic resistance in a wire, which latter manifests itself as a concentric, but not a spherical-concentric, magnetic field.

A stress or stressfield is really a buttress or resistance; it may be chemical, thermic, electric, magnetic, or electromagnetic, mobile or immobile, etc.

CHAPTER XXIV

LIGHTNING

Lightning is the product of what was there, it cannot be the product of what was not there.

Steam, if properly utilised, is an enormous force; it can, as we know, propel a ship of 90,000 tons at the prodigious speed of, say, 29 knots, or be used in a Central Power Station on a scale of equal magnitude.

Steam is the only form, at present, in which the power of water can be utilised. Hydro-electric plants do not use the power of water, that is, either the cohesive or even the adhesive force; they simply use water as *the kinetic energy of a moving mass*.

We saw, on the other hand, from a previous Chapter, that the expansive force which steam can exert is due to the induction of the adhesive force into the bubbles, the bubbles being formed by the crossing of the stressfields—the internal latent stressfield of the water with the heat stressfield from a furnace or the like. In other words, each steam bubble has an envelope of water vapour but specifically charged with the induced adhesive force which has had to be overcome in order to break the water up from a liquid mass into gaseous or semi-gaseous spheres.

Steam is therefore the product of water and adhesive force, the water supplying the mass and the adhesive force of the water supplying the charge, induction taking place through the crossing of the two stressfields.

It was also previously shown that if we could reach and utilise the cohesive force of water we could obtain prodigious force, too vast in the form of pressure to be used in the steam technique. On the other hand, pressure electrolysis indicates the enormous force of cohesion which exists in

water, indeed in all material, for this cohesive force is actually the atomic force.

In the steam technique it would be measured in pressure and on this scale it is probably in the vicinity of 18,000 atmos., or over a quarter of a million pounds per square inch.

Now what is lightning? One fact we know at once, it is the product of what is there and available.

Differences in electrical potential can exist anywhere, where they can, but lightning-material can only form in the clouds. The only ingredients available are heat potential, moisture in vapour form (clouds), and induction from the earth's magnetic field. Therefore lightning-material must be composed of this as there is nothing else available.

Now these three ingredients are nearly always present, but lightning is only an occasional phenomenon in this part of the world. In other parts, *e.g.* the Central American Republics, it is very much more frequent and violent. The reason for this is that lightning only occurs when all the right conditions obtain and at the right moment. Some phenomena depend on a slow and complex process of action and reaction, *e.g.* growth. Lightning-material is formed catastrophically and this means that not only must all the necessary conditions obtain, but that they must be present not merely as ingredients but as conditions *and at the right instant*, otherwise the catastrophic formation of lightning-material cannot take place. It will be obvious that in certain parts of the world magnetic storms are thus more frequent than in other parts, and that in all parts of the earth's periphery clouds can pass and re-pass without this phenomenon occurring, for the reasons explained.

The clouds are vapour—water in a semi-gaseous state—crossing the earth's concentric magnetic stressfield. The gaseous bubbles of steam or vapour are thus charged electrically or magnetically by induction from the earth's stressfield. The bubbles of steam or vapour being electrically or magnetically charged now exert attraction upon themselves and thus form a spherical electronic concentration or ball (and there is a form of lightning in which this

LIGHTNING

condition is recognisable, although it is actually lightning-material). Compression now takes place through this centripetal action, then implosion, and light-matter is formed, as it is a product of such compression, and the electronic ball is brought to the glowing state and "glowing magnetism" is produced in this way.

Lightning is thus a material, an energy-material. It is H and O specifically charged from the H and O stressfield of the Ether and, as has been previously stated, Prof. Mathias declared that he had measured the force available in this lightning-material and found it to be four times that of nitroglycerin.

Nitroglycerin	= 1478 kcal. per grm.
Mathias's experiments	= 5143 " " "
Mathias also declares force	
of lightning	= 2860 m.kg. per cm. ³
1 h.p.	= 75 m.kg. per sec.
Therefore lightning-material	= 38 h.p. per cm. ³

Lightning-material is glowing magnetism, such as is produced in the new Stator, but here also maintained through the new Technique.

The Stator consists of a hollow sphere of suitable metal, correctly wound to produce the proper form and *quality* of electromagnetic field. (See Part II for detailed explanation.)

As replenishment is instantaneous between the PD earth-atmosphere, we may draw at the rate of 38 h.p. per cm.³ from a suitably designed and entirely new Rotor, which is entirely mechanically separate from the Stator, the connection being in "energy form" (crossing of two stressfields).

Calculating now on the Mathias figure of 2860 m.kg. per cm.³, and assuming a Stator, the hollow central space of which is 1 litre, *i.e.* 1 d.cm.³, we have a cubic capacity of 1,000 cm.³ and thus a potential force of 38,000 h.p.

$$\begin{aligned} \text{Now} \quad & 0.5236 D^3 = 1000 \\ \text{Therefore} \quad & D = \text{say } 12.4 \text{ cm.} \\ & = \text{say } 5 \text{ inches} \end{aligned}$$

Overall diameter of Stator having a capacity of 38,000 h.p. based on Mathias's figure, say, about 6 inches diameter.

Directionally, that is, driving a Rotor, only half the Stator (sphere-energy) will be available = say, 19,000 h.p.

Assume a 50% efficiency in transmission, and you have, say, 9000 h.p., which is likely to prove a low estimate. 50% transmission efficiency is allowed between Stator and Rotor, assumed for slip between stressfields and not for heat losses. The stressfield from the sun is not "hot"—it produces heat in air, through crossing with the earth's stressfield. The air, of course, is also present round the Rotor, but the Rotor has no glowing core, so motion is produced without heat. (See Part II for stimulation of Rotor.)

There are other methods of making this same calculation, but these will be discussed when we examine the Technique.

Now this "lightning-material" of Mathias's is glowing magnetism. In the Ether it is a sun or other core-variant. In the air it cannot be permanent because the vacuum force is missing—its complementary stressfield—and it is therefore immediately disintegrated through discharge.

Lightning cannot by any present means be artificially produced in a laboratory. That which is produced between two electrodes under enormous voltage is an electrical stress, which overcomes air resistance and then arcs, giving the same appearance as the arcing due to lightning-material.

Both the lightning flash and this arcing discharge in a laboratory have only come from what was there, and we know that "what was there" in each case was entirely different, although the visible appearance of the discharge is in both cases the same.

But to judge by "visible appearance," although often the only method available to the layman, is not a scientific proof, and it is quite inadequate for scientific investigation.

The force, however, of both discharges can be measured by the established units, *e.g.* volts and amps.

It may be contended that if they are both measurable in the same unit, they must be the same. But, as we have

seen, the origin of electricity from a battery or a generator is the same, although there is a different technique of generation, whereas the origin of lightning differs entirely from either of these.

And in what way does it differ? Lightning from its origin is biomagnetic, it is living energy, whereas electricity and magnetism in the present technique are devitalised; the electric current is a by-product out of the living Space-Force, the other is the Space-Force as water and the earth's biomagnetic stressfield producing "energy-water," or glowing magnetism.

But lightning does not promote or even support life, it brings death and destruction—yes, but for the same reason that water, which is the basic essential to all forms of organic life, when in flood brings devastation in its path.

Heat is used to effect cures in certain ailments, but a fire destroys. The sun promotes or plays its part in the production and maintenance of organic life, but it can also kill!

The biomagnetic force could be controlled and applied to the service of man in all branches of human activities and for all requirements through the new Technique and also for purposes as yet unknown to man.

All this may be of no importance to the engineer or technician, at least until the new Technique functioning on the Primary Force is available, but it must, even now, be of importance to the scientist whose duty it is to be ahead of the technician and to lay the foundation stone for a new technique.

Lightning (not the flash or discharge, but the formation of the lightning-material) is an equalisation of the cohesive force of the vapour and the atmospheric stress-field, the cohesive force supplying the resistance and the motion of the clouds across the atmospheric stressfield giving lightning its potential through the crossing of the energies, without which, as the PP shows, no other form of energy can be produced and no conversion of energy can take place.

It only takes a little observation to realise that this

is just the "Nernst Effect" in another form, thus giving a different product.

We have here cohesive force of water vapour (equivalent of the plate) forming the resistance. This is situated in a magnetic field—the earth's stressfield. But instead of the heat stress passing through the plate in a magnetic field as in the Nernst effect, the plate (the cloud as cohesive force of water) passes across the earth's magnetic stressfield, in this case producing glowing magnetism through the centripetal action of the electrified vapour (conglobation) in place of an electric current, which latter must be formed by compression through the cohesive force of a wire and potentiation.

The basic principle is exactly the same.

In a thunderstorm when lightning-material is forming it absorbs or sucks the oxygen out of the surrounding air; this is only to be expected since, owing to the concentration of hydrogen to form lightning-material, there is an excess of the other component. The two components, however, cannot form a permanent complementary core due to the presence of the air. After the storm the oxygen component redistributes itself homogeneously.

In the case of the formation of a sun or other variant, we saw that there was mobile exchange between the glowing core and the surrounding oxygen stressfield. Here in the air this is not possible, so on formation it takes oxygen out of the air by core-suction, and when the lightning-material is released through discharge, it gives back the oxygen to the air, readjusting the equilibrium.

So lightning-material is ignited H and O energy. If the oxygen energy predominates, cold lightning is formed and *vice versa*.

The quality of lightning can vary through the different qualities of radiation from the earth with which, during a thunderstorm, the thunder-clouds are stimulated.

In short, lightning-material is an electron vacuum-space; as material it is atomic, but the discharge or "flash" is atonic.

The return during the lightning flash of oxygen to the

atmosphere through the medium of the electric discharge produces ozone. Ozone (O_3) is an allotropic form of oxygen, the conversion taking place through an electric discharge, which is not surprising since the electricity itself is also oxygen and hydrogen energy—the hydrogen component dissipating in the ground, to be absorbed as energy-water, or in the atmospheric stressfield, returning to its other form as nitrogen vapour or gas, by energy absorption of the requisite oxygen, if the flash is upwards.

But if lightning can only be “formed in the clouds,” how can the flash be upwards?

This brings us to the question of “atmospheric electricity,” so-called.

It exists beyond all doubt; the atmosphere is electrically charged; scientists can actually measure the charge in volts between the earth-atmosphere potential.

But the atmospheric stressfield itself is a magnetic potential, latent and free; the sublimate of this stressfield in gaseous form is the air, which can receive an electrostatic charge through primary compression; this charge is a conversion or transformation from magnetic potential—a sublimate or energy concentration out of the earth’s stressfield and extra-cosmic radiations, with the air as its containers or hold.

The charge can be compressed to current in a wire, that is, in the apparatus used for measuring the atmospheric electricity.

If the difference in electrostatic potential earth-atmosphere is sufficient to arc, the sign may be negative and the flash is upwards, but it is not so usual because no lightning-material was formed—the same or a similar effect but a different origin. We obtain a similar phenomenon from a Wimshurst machine.

If the oxygen energy in a flash predominates, the lightning is soft; if the hydrogen energy predominates, it is hard.

But there is a third form of glowing magnetism or a second kind of gravitation, to which, if we wish, we may give a plus sign, as it is from our standpoint towards the

earth. This is caused by the fluctuation of heavenly bodies from the resultant centre of the magnetic stressfield to which they belong, and this is the origin of *cosmic lightning*, or cosmic rain, usually known under the name of cosmic radiation (*Ultrastrahlungen*), as also is the radiation through the breaking up of cosmic or heavenly bodies.

This radiation, when crossing our earth's stressfield, produces or contributes to the production of light.

This is lightning in Space, and it is hard neutral carbon radiation, highly penetrative. Because in the breaking up or disintegration of a cosmic body, depolarisation of the core takes place and before return as ether is possible radiation ensues as oxygen and hydrogen energy, or carbon energy radiation.

The saturation of the earth's crust with this cosmic radiation is one of the causes of alpha radiation, the other being saturation from the earth's hydrogen core.

These are also the origin of the radio-activity of the earth's crust, and likewise of radium emanation, certain ores being highly sensitive to and absorbent of such radiation which results in the "over-filling" of their cohesive force, producing radiant emanations (radium).

This lends itself to more detailed analysis later, but the point here is that lightning is H and O energy-material; it is merely the ether energy in specific condition. It manifests itself in three distinct forms:

1. *As a hydrogen core of a sun or other variant, spherical-polarised mobile H and O energy-material.*
2. *As spherical-polarised H energy but without its surrounding and complementary energy stressfield—in air, and is thus immediately dissipated as a flash or discharge. (Lightning proper.)*
3. *As cosmic radiation through the disintegration of the core of cosmic bodies and through the fluctuation of cosmic bodies from their magnetic centre of the magnetic field system to which they belong.*

LIGHTNING

In (1) it is the vacuum force in atomic condition—the real atomic force, the cosmic or Space force, the Primary Force.

In (2) it is vacuum force but lacking its complementary other half and thus unable to hold its Space-form; therefore it is atomic only at the instant of formation and then atonic in discharge as flash.

In (3) it is the radiation derived from the disintegration of vacuum cores or produced by an asynchronous motion of some unit or units in a cosmic magnetic field system.

In the first case Indication is continuous.

In the second case Indication is only instantaneous.

In the third case “the cosmic lightning” is the result of the cessation of Indication due to disintegration of a “core”; or partial instantaneous Indication as primary compression due to asynchronous motion of a cosmic body, which signifies extracentric motion or “crossing” outside its balanced stressfield, resulting in radiation (dynamic as motion), and not as a static energy membrane or stressfield. This is best defined as Atonic Indication.

What is the primitive energy-material? Fire.

Lightning is energy-material, the clouds are the “electrolyte” with motion—equivalent to the armature of a generator.

But lightning has itself no container or “hold.” The container or “hold” for a cosmic core is its complementary stressfield. Lightning in air has none.

When it has also no electric container or hold (no clouds), no lightning-material is formed.

A sun’s core is in “dynamic balance” due to Indication and mobility.

An electric current is disciplined through its circuit, which is its “hold,” producer and container.

So lightning in air exists only instantaneously due to its unbalance, whereas Cosmic Lightning of either type exists as a dynamic balance due to its radiation as cosmic rain so long as the cause obtains, and the cause here is continuous and never-ending, because disintegration and asynchronous motion of cores and cosmic bodies is a never-ending process.

CHAPTER XXV

SUPRA-CONDUCTIVITY

We have examined into the cause and origin of free electromagnetism in Nature: in the Cosmos, when complete as a sun or glowing hydrogen core, yet circumscribed as space-form and entity (biomagnetism) through its complementary oxygen stressfield, thus, permanent and stable only as both mobile and translatory dynamic balance; likewise the same phenomenon but in air, as lightning-material with instantaneous mobility followed by immediate disintegration owing to the lack of complementary stressfield—the sun being thus a complete vacuum and permanent as such, but lightning-material, a complete vacuum only for an instant; finally, we have mentioned electromagnetism due to the reverse, the breaking up instead of the formation of these glowing hydrogen cores, or due to asynchronous motion of one or more units from any given magnetic cosmic system.

We have explored the origin and cause, the nature and characteristic of electromagnetism, produced artificially and generally known as the electric current, and we have seen that for this three essentials are required:

- (1) An impolar magnetic field of imposed form.
- (2) An electrolyte, dry but capable of rotation.
- (3) A conductor in which energy compression can take place and current, as such, can form with space-form.

It is case (3) that concerns us here.

Now, we have found from the Nernst (and other “effects,” which latter merely ring the changes) that all forms of energy have a common origin and that any one of these can be converted into any other form when the right conditions are present and available.

It thus follows that magnetism is Heat and Cold stress and that as the electric current is milled-up, compressed, highly-potentised magnetism, it must also be heat and cold energy, but in a specific condition and form, which manifests itself as such only under very special conditions, as we have seen.

Nevertheless, the electric current has always the characteristic of heat and cold stress within itself, which, without visible manifestation as heat and cold, is capable of invisible functioning in energy form as a PD, and we know the PD is the essential condition for any current to flow.

But we can produce a PD in many ways: by a battery, a generator of various forms, and, in fact, by a resistance through the use of an instrument known as a potentiometer, because the portion of this instrument in use in any given circuit occasions a drop in potential, giving rise to a PD.

With these facts in mind, and the knowledge gained in Chapter XXIII, we may examine the cause of the phenomenon known in modern physics as "supra-conductivity."

In order to explain this completely we must be able to account for two phenomena, viz. the disappearance of resistance and the behaviour of the magnetic flux, as it is not yet definitely known to the SP whether the primary effect is due to supra-conductivity or "subpermeability."

The magnetic energy of a supra-conducting circuit is constant and equal to the energy subsisting when the supra-conducting state was attained.

One method of producing a permanent current is by placing a closed supra-conducting circuit in a magnetic field, the current being induced into the circuit which, owing to the absence of electrical resistance, continues to flow for an indefinite period.

The source of the current here is therefore magnetic induction, *i.e.* as we have seen, "magnetic evaporation" from the solenoid caused by the suction or cohesive force of the conductive circuit in the supra-conductive state.

Another method is that in which the closed conducting circuit is placed in a magnetic field and then cooled below its

transition point, but the induced permanent current is then of opposite sense.

In both cases the permanent current continues without appreciable loss in strength until the liquid helium has evaporated.

First of all, here is a further proof that the electric current is magnetism and that the functioning of the wire converts it to current through compression and potentising, because all we induced in both cases was "magnetism."

The supra-conducting metals having a very low magnetic susceptibility, the absorption of the magnetism produces a current instead of magnetising such substances, which in steel produces a polarised magnetism and in copper an impolar magnetic field, at all ordinary temperatures.

Some of the principal substances which exhibit the properties of supra-conductivity are:

<i>Substance</i>	<i>Temperature (Degrees K)</i>
Lead	7.2
Mercury	4.29
Tin	3.78
Thallium	2.32

The electric current is heat and cold stress; if, as in the first place, a supra-conductive closed circuit is placed in a magnetic field, the cold stress component of the current will function with the cold stress of the conductor and a current will be produced in one sense; if, on the other hand, the closed conductor is placed in a magnetic field and then cooled below its transition point, the heat component is superimposed before the transition point is passed and the current is then of opposite sense.

The current in both cases is due to the potential, producing a potential difference, a potential difference in the "energy form" of heat and cold stress. The path is the cold stress of the cohesive force of the wire, the force is the mobile stress of the current, and "work" is force times distance (way or path). This is usually applied to dynamics but if true it holds in electrodynamics also, as we have seen

in a previous Chapter (XXIII), from the fundamental formula for the electric current.

So the phenomenon known as supra-conductivity is caused by the PD existing between a bound cold stress and a mobile heat stress, but normally operating directly as electric potential.

In such cases in physics or nature there is always a critical point when any given phenomenon begins to function; in this case the critical point is termed the "transition point" and it is of course determined and found to be specific to the respective materials, because although this is an energy phenomenon—all phenomena in physics and chemistry really are—it is nevertheless not energy but material which dominates; this means that the transition point is determined by, or is specific to, the entity or organic characterisation of any given substance, under test.

Virtually the above statement amounts to the assertion that the permanent current in supra-conductivity is due to the electric current functioning through its other characteristic, viz. heat and cold stress, instead of through electrical PD, both (as has been explained) being different forms of the same phenomenon, magnetism, and operating in this case due to the intensely high "cold stress" of the conductor.

In other words, Low Temperature Physics should be re-named Cold Stress Physics, and the phenomenon of supra-conductivity would then be explained from an entirely different angle.

The researches of F. and H. London replace Ohm's law for a supra-conductor by electromagnetic equations of the following forms:

$$\begin{aligned} E &= \Lambda(\dot{I} + c^2 \text{grad } \rho) \\ H &= -\Lambda c \text{curl } I \end{aligned}$$

where ρ is the current density and $\Lambda = m/ne^2$, which permits the existence of an electrostatic field in a supra-conductor. In fact, it has been shown that permanent currents cannot exist without the presence of a field, but in order that even this field may exist, a magnetic field is also necessary which may, however, be the reciprocal of the current itself.

Let us now try to clear up this complexity. The complicated and almost contradictory evidence of the behaviour of the magnetic field, hysteresis phenomena and disappearance of resistance, is due simply to this functioning of the current on its heat potential characteristic instead of its electrical potential, the electrostatic and magnetic fields produced being in this case the reaction arising from the heat stress potential and its conversion into electrostatic and then magnetic fields, or reciprocal of the current flowing, but in this case conversion from *energy potential as heat* instead of from *energy potential as current*.

It should, however, be clearly understood that this is not heat potential as temperature but in the energy form, which converts on reaction of entropic pressure into electrostatic and magnetic fields, these fields being really energy sublimates.

But is not the law of conservation of energy being violated?

No, the energy of the circuit is maintained by the supply of "cold stress," *i.e.* when the liquid helium evaporates the current ceases to exist. The ideal Carnot is a heat potential energy, the working fluid being in vapour or gaseous condition. In the supra-conductor we have energy heat potential, which functions as such so long as the temperature of the conductor is kept below a certain critical or transition point.

It was stated at the beginning of this Chapter that all forms of energy have a common origin and that any one can be converted into any other form when the right conditions obtain or, as Schappeller himself used to put it, "any form of energy can be converted into any other form, *if it can.*" We have seen that this is true in the case of magnetism being converted into electricity, likewise heat into electricity and *vice versa*, but is not the claim that any form of energy is convertible into any other form not rather too extravagant?

Well, heat produces mechanical strain in steel and cold produces compressive stress—so mechanical stress and heat are convertible.

But can you by compressing a substance produce electricity? The reply is yes, if you can—if the right conditions exist. When certain crystals such as quartz or Rochelle salt are compressed, the opposite faces become charged with positive or negative electricity. If the crystal is elongated instead of compressed, the charges on the opposite faces are reversed.

Conversely, when the two opposite faces of such a crystal are charged oppositely, the crystal is compressed or elongated, and other variations of this experiment are possible. This is known in the SP as Piezo-electricity.

And what is the explanation of this Piezo-electricity, but merely that which has already been given, viz. electricity is compressed magnetism. The cohesive force of all material is latent, equalised-out, impolar magnetism; when this is mechanically compressed in a suitable dielectric substance an electric charge occurs. The appearance of this charge on the faces of the crystal is therefore an energy eublimated out of the cohesive force, which is reabsorbed (in energy form) when the pressure or tension is removed. And, conversely, when the two opposite faces are charged, over-coming of the cohesive force ensues, causing distortion as filongation or compression.

CHAPTER XXVI *

GRAVITATION

In order to reveal and establish the new gravitational principles and laws in accordance with the Primary Physics, it is necessary to make a general survey of this subject as the SP presents it, from a wealth of experimental data, checked exactly by mathematical calculation.

It would obviously be quite inadequate to attempt this, unless such new principles and laws can be shown to explain the origin-cause of the phenomena determined and proven by present Physics.

The SP has established beyond all doubt *that every particle of matter in the Universe attracts every other particle with a force proportional to the product of their masses and inversely proportional to the square of the distance between them.*

Expressing the law in symbols,

$$F = K \frac{M_1 M_2}{R^2}$$

K being known as the gravitational constant, *i.e.* a constant of proportionality, the value of which is 6.68×10^{-8} gram⁻¹ cm.³ sec.⁻². M_1 and M_2 are the respective masses and R is the distance between them.

The law of gravitation has been verified in the following manner:

The moon's orbit is approximately circular and its distance is nearly sixty times the earth's radius, denoted

* Reference throughout this Chapter: Grimsehl's *Physics*, from which formulæ and data are taken, in some cases verbatim, and likewise Arthur Haas, *Introduction to Theoretical Physics*, Vol. I.

here by R. A sidereal month is 27.32 days. Acceleration of the moon towards the earth is thus given by:

$$\begin{aligned}
 a &= \omega^2 60R \\
 &= \left(\frac{2\pi}{27.32 \times 86400} \right)^2 \times 60 \times 639500000 \text{ (cm./sec.}^2 \text{ approx.)} \\
 &= .2716 \text{ cm./sec.}^2
 \end{aligned}$$

and if the moon is held in its orbit by the force that causes a stone to fall, then

$$\begin{aligned}
 \frac{a}{g} &= \frac{1}{60^2} \quad \text{therefore } g = a \times 60^2 \\
 &= .2716 \times 3600 \\
 &= 981
 \end{aligned}$$

which proves the supposition to be correct.

The force of attraction between two bodies on this earth has been proved through the well-known Cavendish experiments, in which a horizontal rod with two lead spheres of 2 in. diameter at its ends was suspended on a long fine wire. If this rod was acted on by a couple in a horizontal plane, it turned, the wire becoming twisted, and took up a new position of equilibrium.

This instrument verified the laws of gravitation, confirmed the formula, and enabled the earth's density and weight to be calculated.

It confirmed Newton's law that *the force of attraction between two small bodies or between two spherical bodies of any size is proportional to the product of their masses and inversely proportional to the square of the distance between their centres.* This formula has just been given.

Coulomb discovered that the same principle or law holds in the attraction between two magnetic poles, and this is often known as Coulomb's law, expressed as follows:

$$P = \mp \frac{m_1 m_2}{r^2} \quad (\mp \text{ means attraction or repulsion)}$$

$$P = 1 \text{ (dyne) or } 1 \text{ (cm. g. sec.}^{-2}\text{)}$$

$$m_1 = m_2 \text{ in polar interchange}$$

$$= 1 \text{ (cm.}^{3/2} \text{ g.}^{1/2} \text{ sec.}^{-1}\text{)}$$

$$r = 1 \text{ cm.}$$

GRAVITATION

Or again, for Coulomb's law applied to electrostatic fields:

$$P = \mp \frac{1}{\epsilon} \frac{Q'Q}{r^2}$$

$\epsilon = \text{unity (in a vacuum)}$

$$Q' \text{ or } Q = 1(\text{cm.}^{3/2} \text{ g.}^{1/2} \text{ sec.}^{-1})$$

$r = \text{cm.}$

Formulae can be used in two ways—(a) quantitatively and (b) qualitatively.

In (a) the purpose is to make some definite calculation; in (b) they can be used as a shorthand, through inspection. If the formula in question is a monomial, inspection and analysis will tell the way the factors vary, their relative importance, value, and also their quality.

Coulomb obviously used this and realised that if gravitation was a fundamental force, then other manifestations of this force must also follow the same principle as that expressed in the general gravitational formula. Observe now the same principle in all the formulae, but containing in each case the appropriate notation:

$$(1) F = k \frac{M_1 M_2}{R^2} \quad \text{for gravitation}$$

$$(2) P = \mp \frac{m_1 m_2}{r^2} \quad \text{for magnetic poles}$$

$$(3) P = \mp \frac{1}{\epsilon} \frac{Q'Q}{r^2} \quad \text{for electrostatic fields}$$

Now there are many experimental methods and proofs that the acceleration due to gravity is 981, and that it varies exactly inversely as the square of the distance from the centre of the earth. The earth is an oblates spheroid; the poles are therefore nearer to the centre than the Equator:

For the pole	.	.	983.216	}	by one observer
London	.	.	981.190		
Mauritius	.	.	978.623		

But what is the true significance, that is, the physical meaning of this 981? We cannot or must not attempt to proceed until we know this.

A spherical mass the density of which is either uniform or depends only on the distance from the centre acts at an external point as if the whole mass were collected at its centre.

This means that we may assume the attraction of the earth, sun, or other variant to be concentrated at its centre.

Now the potential at any point on the earth's surface is expressed by

$$V_0 = fM/R$$

where M is the mass of the earth and R its radius, and which gives the surface potential as 6.24×10^{11} ergs/gm. This represents the work per gram required to remove a mass from the surface out of the earth's field of influence.

To use a gun for this purpose would require a muzzle velocity of about 11-12 kilometres per sec., about eleven times as great as the normal velocity of a shell.

Hence the idea of the rocket, generating this colossal force by means of motion accelerated over a long period and thereby eliminating the impossible problem of manufacturing an inner tube which would support such a velocity.

It will, however, be seen later that this could be best accomplished by the Primary Physics and its new Technique, and by entirely different means.

The Earth's Homogeneous Stressfield.

If we calculate the distance between equipotential surfaces in the earth's field and if the potential difference for the two is 1 erg/gm., we find that $h = \frac{1}{981}$ cm.

This must be so because if we raise 1 gm. 1 cm. at the earth's surface the work done is 981 ergs.

At greater heights the distances between equipotential surfaces will become greater.

The distance between two level surfaces for a potential difference of 1 erg/gm. becomes n^2 times greater when the height above the surface increases n times.

A homogeneous field is thus one in which equal dis-

placements in the same direction correspond everywhere to equal differences of potential $V_2 - V_1$. In any given direction the potential slope must be the same at all points. The gradient of potential and field strength are always constant.

This is the mathematical proof of the earth's homogeneous concentric magnetic stressfield, but it does not of course take into account quality of energy, that is, the bio-magnetic quality of this field. Quality of energy is dealt with later.

The interpretation of all this data will be given shortly, so let us proceed.

The field strength of the homogeneous field of the earth near the earth's surface is 981 dynes per gm.

The field strength is the force on unit mass. The force on the mass m is the product of the mass and field strength, *i.e.* $P = MF = mg$.

Lines of force run at right angles to the equipotential surfaces; in the case of a sphere or the earth they are radii.

The lines of force give the direction of the field; in order to represent its magnitude, a number of lines of force are drawn, each through unit area of the equipotential surface corresponding to the magnitude of the field strength at the point considered.

In the case of the earth's gravitational field the field strength is 981 dynes/gm., which means that 981 unit gravitational lines of force pass through each square cm. of a horizontal plane near the earth's surface.

The earth's gravitational flux is thus 981 per cm.² or the flux through, say, 10 cm.² is 9810. This is the significance of 981.

But the force of gravity is affected by other factors, attributed partly to the centrifugal force of the earth's rotation, and to the effect of the sun and moon, which latter has been calculated, also to differences of density in various strata and local conditions.

At the foot of an isolated mountain a plumb line shows a measurable deflection from the vertical, *i.e.* the line to the earth's centre, and knowing the mass of the mountain

the earth's density can be calculated. The mountain Schiehallion in Perthshire was actually used for this purpose.

That amazingly accurate and practical instrument, the Eötvös Torsion Balance, is an application of this basic principle.

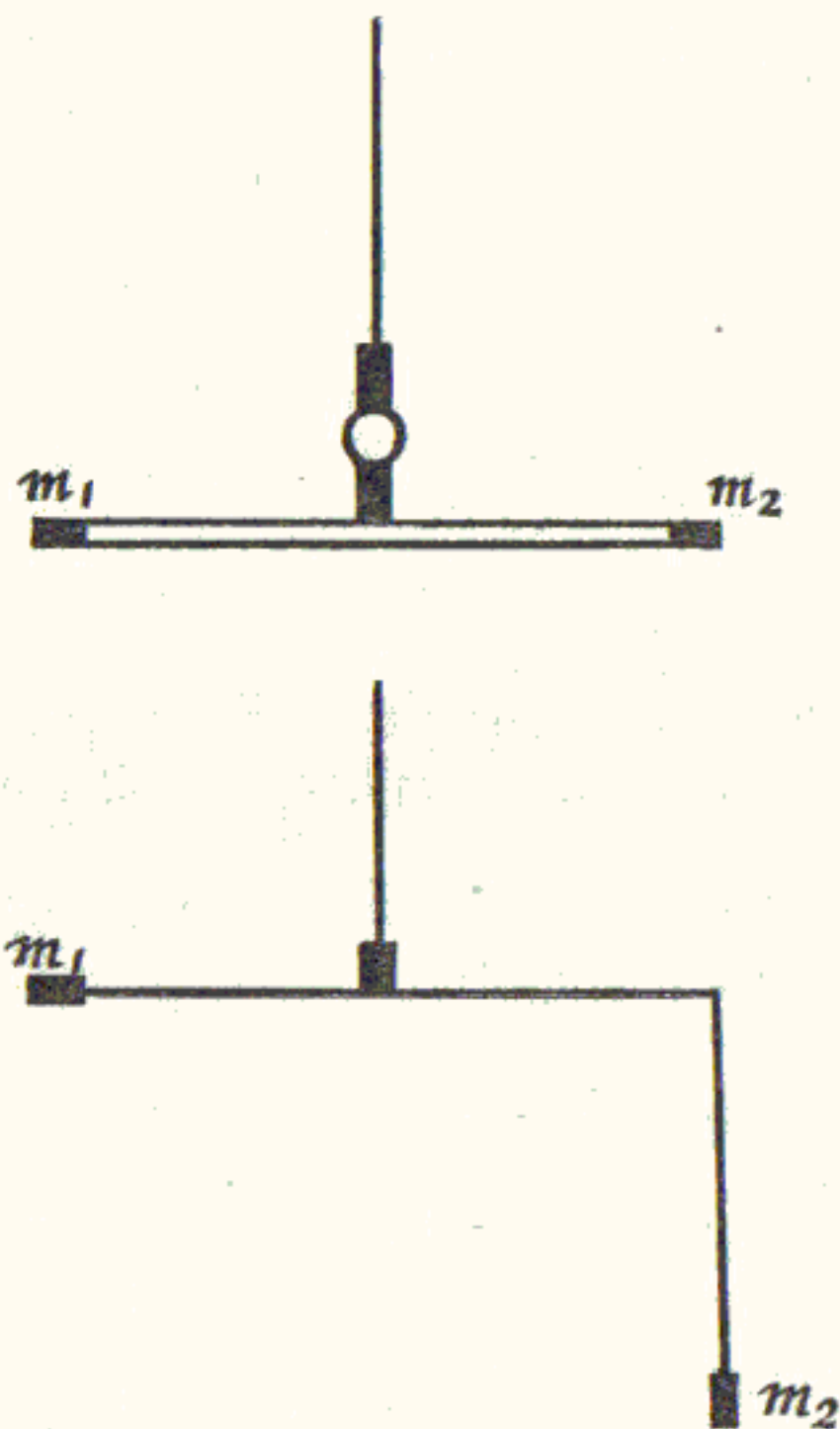

FIG. 11

It consists of a light hollow aluminium beam carrying two small weights at each end. In the second form the weights are at different levels (see Figures).

This application of the gravitational law is used in prospecting, and especially in making subterranean surveys of prospective oilfields with a view to the exploitation of petroleum on a commercial scale, where the conditions are suitable.

The instrument is very elaborate and accurate, and for

the above purpose measures three different components of the earth's gravitational field:

1. The horizontal component.
2. The space-rate of change of that horizontal variation of gravity.
3. A quantity termed the differential curvature.

In other words, it gives the mathematical measurements of the distortion of the earth's homogeneous field due to the presence of bodies of greater density than the otherwise homogeneous earth's mass, which set up their own gravitational fields.

The vertical component of force on the beam is taken by the suspending wire and the horizontal component produces rotation, the deflection being read by a mirror. By this means the *direction* of gravity and thus the curvature of the equipotential surfaces can be measured.

We are not concerned here with the actual mathematics, which is very complex, but merely with the gravitational principle involved and its practical application.

Proportionality of weight and (inertial) mass. It was proved by Newton that the force of gravity on any given body is proportional to its mass, irrespective of the material of which the body consists. This also applies to living organic bodies.

Even radioactive materials such as uranium compounds do not appear to deviate from this law.

The Eötvös Balance can be used also to compare "inertial force" with the force of gravity, the inertial force being the centrifugal force due to the "earth's rotation."

The weight of a body at the earth's surface is the resultant of gravity towards the centre and the centrifugal force parallel to the Equator.

To use the instrument for this purpose, in the Schiehallion experiment the beam of the balance was first set in the eastward direction and then turned through 180° . The position of the beam remained constant, but a deflection of 6×10^{-4} secs. of arc was observed, proving equality of gravitational and inertial mass to 1 part in 200 millions.

Thus gravitational and inertial mass must be identical, and the Eötvös experiments show that this is true irrespective of the magnitude or chemical composition of the mass in question.

In classical mechanics this has long since been accepted as fact.

The Earth's Rotation.

The angular velocity measured in radians is

$$W = 7.272 \times 10^{-5} \text{ sec.}^{-1}$$

Now let us consider a freely-falling body. The Coriolis force always produces an *easterly deviation* in such bodies and the total easterly deviation may be expressed by the formula

$$x = \frac{2\sqrt{2}}{3} \frac{h^{3/2}}{\sqrt{g}} w \cos \psi$$

If we take London as an example and a free-falling body from a height of, say, 100 metres, then

$$w \cos \psi = 4.527 \times 10^{-5} \text{ sec.}^{-1}$$

$$\psi = \text{latitude } 51\frac{1}{2}^\circ$$

and the formula thus gives an easterly deviation from the vertical of 1.36 cm.

If we now consider the case of projection vertically upwards, the relative velocity here being opposite in direction to the falling body, *westerly deviation* will ensue represented by

$$x = \frac{8\sqrt{2}}{3} \frac{h^{3/2}}{\sqrt{g}} w \cos \psi$$

which shows that westerly deflection is four times as great as easterly, substituting for twice the time of ascent.

Furthermore, the Coriolis force deflects every horizontal motion in the northern hemisphere towards the right and *vice versa* in the southern hemisphere.

Einstein's generalised Law of Inertia, which is really the new Law of Gravitation, means that every particle moves in such a manner *that its world line is a geodesic in a curved*

world, the important point being that the curvature is caused by matter.

This means, of course, that a geodesic is also a curve, and that all matter is a source of gravitational force and "exerts attraction."

As we have already seen, it has been experimentally proved, checked and counter-checked that the acceleration due to gravity (which, on any given mass, is proportional to the gravitational force) varies inversely as the square of the distance from the centre of the earth, but at the actual centre of the earth there is no gravitational force.

This leads directly to the question, what is the nature of the centre of the earth, that is, is it gaseous, liquid or solid?

Physicists have investigated this principally from tidal and seismological phenomena, and the corresponding *rigidity* implied.

This has led to the suggestion that the central core of the earth is liquid, having a radius of about half that of the earth's radius, that is about 2,000 miles.

It was considered that a liquid core could be reconciled with tidal and seismological data, but that a core with a rigidity related to its bulk-modulus (about 10^{13} dynes/cm.²), in any ratio admissible for a solid, would be entirely impossible.

The application of the Primary Physics to the problem of gravitation.

Let us now examine all the problems contained in this short survey, and in order to avoid confusion we will first build up the earth on the laws which we have established in the previous Chapters, and thereby explain the nature and functioning of the earth's gravitational force.

Shall we begin at the crust, or examine this as present Physics attempts to, from tidal or seismic reactions and other observable phenomena, or shall we start our investigation at the centre of the earth?

Obviously, in order to investigate cause we must examine origin, and the earth's origin is at its centre, its physical centre.

We need not labour the point, which has already been dealt with in previous Chapters, that the earth's central core is neither liquid, solid nor gaseous, but that the earth originated from this core, and that all origin-matter is energy, therefore the earth's core is energy. The exact manner in which this core was formed has already been detailed, and likewise that the core is a glowing hydrogen mass or glowing magnetism of immense density, but being energy and not solid matter it is of no "bulk-rigidity." Thus, without contravening rigidity limitations demanded by surface phenomena, this eliminates the necessity for postulating a liquid core, which could not possibly perform the functions necessary to the formation or maintenance of an organic earth which, as such, constitutes a *living, conscious organism*; nor could a liquid core produce gravitational attraction.

Neither a solid nor a liquid core could promote mobility nor function the energy cycle; thus the crust could not be woven or maintained, and incidentally the earth could not hold its position in space except through the reaction of the core's compression, that is, by exerting a pressure through its stressfield against the ether-membrane.

There is nothing else available to satisfy these conditions.

The earth's stressfield varies inversely as the square of the distance from the centre, but in the core itself there is no stressfield outwards but a compression spherically, concentrically, upon the geometric point of origin, establishing a physical point, the reaction being a stressfield which at the earth's periphery has been established by experimentation and mathematical analysis to give a field strength of 981 dynes/gm.

This stressfield is also said to exert a gravitational pull on all mass or objects within the earth's sphere of influence, and thus to cause bodies to fall radially towards the earth's centre, except for other disturbing forces; furthermore, to produce in such bodies an acceleration known as $g=981$ (cm. sec.⁻²).

We are now confronted with such words as inertia, inertial, acceleration, momentum, kinetic energy, etc.

A body at a given height above the earth's surface has potential energy due to, or by virtue of, its height. But, if falling freely, it has kinetic energy by "virtue of its motion."

The potential energy here is . . . mg
 The work done by falling is . . . mgh
 and since $2gh = v^2$ or the final velocity
 the kinetic energy is . . . $\frac{1}{2}mv^2$

and this is the general expression for kinetic energy throughout Physics for bodies in motion under any conditions—here above it refers specifically to falling bodies.

So kinetic energy is energy which exists in a moving body by virtue of its motion; potential energy by virtue here of its height; acceleration in a body, by virtue of the gravitational pull, and so forth. Evidently the secret of all these exactly coinciding phenomena, which forms the basis of the present subject known as Dynamics, lies in the quality and nature of the so-called "virtue of motion." In other words, why does a body in motion, either when falling freely under gravitation or when propelled by any other means, "have energy by virtue of its motion"?

The fact is undeniable as expressed by the universal energy formula, but we are concerned here with *cause*.

When a body falls or moves in any direction, its cohesive force crosses the lines of force of the earth's stress-field, and it is this *induction of the earth's stressfield into the energy frame of the body which is the virtue that gives it its motion—or kinetic energy.*

It thus follows that the acceleration of falling bodies is due to these bodies crossing these lines of force, increasing in numbers or intensity inversely as the square of the distance of the body from the earth's surface. A ship, a train, an aeroplane, or a man walking are all crossing the earth's stressfield, and, provided the motion is concentric with the centre of the earth, no acceleration ensues unless imposed by exterior means.

Inertia is thus not a force which "resists motion" but

rather the reverse, *the capacity of a body to receive induction (or the universal impelling force), which it may store in virtue of motion.*

If we fire a shot from a gun, after the shell has left the muzzle, what is causing it to traverse its trajectory?—a problem which lends itself to exact calculation and in which the exterior and interior ballistics agree very accurately.

Obviously, here again the propellant, when fired, produces expanding gases which drive or impel the shell up the bore of the gun with a very high rate of acceleration, thus imparting kinetic energy to the shell.

But the true explanation of the kinetic energy imparted is the lines of force crossed by the shell in traversing the bore. The “work done” on overcoming friction is wasted energy, due to the inefficiency of the mechanism employed; the only energy available to enable the shell to traverse its already prescribed trajectory is that stored in the shell itself, or imparted to it, and this storage is of two forms—directional and qualitative; that is, the directional induction of the earth’s magnetic field into the cohesive force of the shell—there is nothing else available. (See page 208, para. 2.)

The kinetic energy available is always exactly proportional to the mass of the shell, that is, the quantity of matter available in which induction can take place and the time for which this induction continues, or, in other words, it is proportional to the mass of the shell and the square of the velocity with which it left the gun, the exact proportion being $\frac{1}{2}mv^2$.

How efficiently the shell uses this available energy is a matter for external ballistics and depends largely on what is termed the “ballistic coefficient,” which is, however, technique and does not affect the origin cause of imparted energy or motion.

On its upward flight it is cutting fewer and fewer lines of force per unit of time and its induction is thus less up to the top of its trajectory, when it begins to fall and commences cutting a greater number of lines of force and thus accelerates towards the earth due to the increased induction.

In vacuo the trajectory is a true parabola, being

always the resultant of the induction vectors, that is, of the shell's induction velocity and gravitational pull.

The inertial mass is the same irrespective of magnitude or chemical composition, because the cohesive force of all mass is identical, and itself being latent magnetism can be acted upon "when it can" by the origin of the earth's gravitational force, the central core.

Physics at present declares that the gravitational force of the earth exerts a pull on all bodies, but without giving the slightest evidence of the origin of such a gravitational force nor the manner in which it is able to exert this attraction.

Now the reason that an unsupported body falls to the ground is primarily because it has "no hold" on the medium. It was previously explained that any inert mass or body has only a latent stressfield which functions merely as the force of cohesion and has no mobility and thus only a latent internal stressfield and no external stressfield. This means that it has no "hold" on any elastic medium such as the ether or the air, therefore it must fall, and it falls towards the greater inductive energy.

If the inductive energy, through some exterior cause, could be made suddenly to increase enormously, there would come a point when the body would be supported, or rather suspended, before it reached the earth's surface.

The new Technique could accomplish this by placing a Schappeller Stator in the body in question, where the body is suitably constructed, thus setting up a glowing magnetic stressfield which would hold or keep the weight or mass of the unit body suspended, *not in the air*—the stressfield would have no reaction on the air—but only on the earth's magnetic stressfield.

This is the basis of the new principle for "ether-ships."

Even at present, all bodies do not fall to the ground; those lighter than air rise. But not merely because they are "lighter than air."

A body at present can only be made to rise from the earth's surface *in the air*; there is no other means known to Physics at the present day of utilising the ether as the vehicle or medium of suspension for a free body.

Furthermore, a body can only rise in the air

- (a) through dynamic balance—by virtue of its motion;
- (b) if it is lighter than air, but not merely because it is lighter than air.

No rigid balloon or ship of any form has ever yet risen from the ground. So-called "rigid airships" rely on gas-bags to raise and support them in the air, the rigid covering providing only structural stability and a streamlined form, for reduction of air resistance and for manœuvrability.

One of the American Naval yards produced an airship of aluminium alloy but consisting of very thin laminae, which could be expanded as a whole like a gas-bag, and this fulfilled the required conditions.

Many years ago, the Germans experimented with and finally produced an aluminium alloy stronger and yet lighter than balloon fabric and filled it with hydrogen, but it would not rise; it had no "hold" on the atmosphere (air), because it was rigid and could not be expanded.

If a small model balloon of any convenient size were to be constructed, say a sphere of glass, aluminium alloy, or like suitable material, and filled with hydrogen, so that the algebraic sum of the balloon and hydrogen were less than the weight of the air displaced, such a balloon would not rise because, being rigid, it has no hold.

In other words, in order that any body shall rise without any form of mechanical propulsion to give dynamic balance, the body must be expanded against the atmosphere (air) to give it a "hold." The exact manner in which this hold takes place is as follows:

The hydrogen or helium gas, with which any balloon is filled, must be in a state of expansion or tension. The energy-frame, or the gas as energy, is then directly in connection with the atmospheric stressfield but through the gaseous state, *i.e.* the gaseous hydrogen or helium and the gaseous air. These two stressed gases, or these two gases as stressfields, support the balloon material (or the weight

of the balloon) between them through the cohesive force of the balloon fabric, provided always that the gas within is "tensioned" or in a state of stress due to expanding the balloon fabric.

As has already been explained, the new Technique will not concern itself with the air as a supporting medium, but directly with the ether. Therefore, the body may be a vertical sealed cylinder with conic ends or any other suitable form. Such a body is obviously rigid and inelastic, and it must contain an ether stress of sufficient intensity to support its mass against the ether stress of the earth's stressfield, which means that the glowing magnetism core in the Stator, provided in the body to be lifted, must be able to vary its intensity according to the height at which the ether-ship is to be raised and supported whilst in transit, as the ether stress or field, itself, varies inversely as the square of the distance from the earth's surface. The actual design and solution of all the various problems in the production of such ships, the choice of methods of propulsion, whether independent or directional, belong to the new Technique, whereas here we are only interested in the principle as applied to the problem of Gravitation.

So the law is not that a body will rise merely because it is lighter than air, but rather that,

In order that any body shall rise, independently, from the earth's surface, such a body must be able to exert a hold either on the air or the ether (the earth's stress-field) through which it is to be supported. If the hold is to be on the air, then the algebraic sum of the weight of the body and the lifting gas must be less than the weight of the air displaced, and the lifting gas must be expanded (tensioned) against a suitable fabric or material, capable itself of expansion. On the other hand, if the hold is to be on the ether or the earth's stress-field, then the body can be rigid in form and of any weight consistent with the intensity of the stressfield which a suitable Stator can supply, the lift here being due to the intensity of the Stator's stressfield against the

ether or atmospheric stressfield—the principle on which all heavenly bodies are supported in space.

(See also Blausen experiments (Appendix (6).)

Weight of a Body.

Now the SP has established that the weight of a body depends on two factors or rather vectors. It is the vector sum of the earth's gravitational pull and the earth's centrifugal force, the latter due to the earth's rotation from west to east.

It has indeed been proved that bodies moving eastwards actually weigh more than a stationary body or those moving westwards, and if the first assertion is true the second must obviously follow; because the vector sum of the two forces (since the centrifugal force is tangential to the gravitational force) must have a vertical component which must be added to the gravitational force and thus increase the weight or gravitational attraction on mass.

If the body is moving westward the speed of the body must be subtracted from the earth's peripheral speed, and the vertical component or vector to be added must be proportionately less.

But the PP does not admit that the rotation of the earth's crust has been established; nevertheless, it does establish the rotation of the earth's field, as rotary stimulation (Chapter XXI, p. 132).

The earth's crust does not rotate but only the earth's field, due to the sun's revolution round the earth by which it carries the earth's field with it; bodies travelling eastwards are thus receiving or experiencing increased induction due to travelling towards the direction in which the earth's field is rotating.

The earth's field has no centrifugal force as such but the body, through induction, is gravitationally charged, *the hold is increased*, in the same way (as it has been explained) that a free-falling body receives its acceleration by passing through the denser layers of the earth's field, and thus the pull on a body moving eastwards is increased, or the body increases in weight because the hold here is not on the atmospheric stressfield, but increased attraction or stimula-

tion through the central core, since the gravitational charge originated from the central core.

Whereas, to increase the supporting force or hold it is necessary to set up, and within the body itself, a new gravitational source or stressfield through the medium of a Stator.

The Coriolis force. The functioning of this force depends on the position of the observer. It is really a deflecting force due to the "earth's rotation," its value being always proportional to the moving mass; since it acts at right angles to the direction of motion, it is merely a *distorting force* doing no "work." It therefore may be classified under "forces of constraint," having its origin in *the inertia* of the moving body in question.

In place of the earth's rotation and corresponding centrifugal force, we have here again the rotation of the earth's magnetic field which, viewed from the North Pole, is clockwise. The vectors are thus similar, the radial gravitational pull and the induction of the earth's field into the moving body, tangentially.

When the body is projected vertically upwards it crosses the earth's stressfield in the opposite direction or sense, producing a deflection in the opposite sense, westerly, during the upward movement.

But there is one missing factor; since the earth's crust is not rotating, there can be no "displacement" of the body due to the time it is in the air, and we have seen that in a free-falling body from a height of 100 metres the displacement is 1.58 cm. eastwards, and four times that westwards if the body is projected vertically upwards the same height and allowing for twice the time of ascent.

How can the PP account for this?

Now, if it were merely a question of displacement with regard to time of flight there could be no easterly displacement; therefore there is a force acting, although it is only a *distorting force*, and we are told that this force has its origin in the inertia of the body, which the PP defines as the capacity of a body to receive or assimilate induction and which is always directly proportional to its mass.

When the body is falling it is crossing the earth's

stressfield in one direction, producing an easterly deflection, and when it is rising, westerly deflection ensues, because it is crossing the earth's stressfield in the opposite direction.

Although the induction in both cases is east-west into the body as the rotation of the earth's field is in that sense, in the falling body it is increasing and in the rising body decreasing because of the greater and lesser number of lines being crossed per unit time, respectively. Herein lies the origin of this "inertia" force, the greater force producing a very small horizontal component against the earth's rotating field or eastwards, and the smaller force due to upward motion of the body producing a larger (yet very small) horizontal component with the rotating field, thus giving a larger displacement, westwards, in the direction of the earth's field, the earth's field, of course, rotating at exactly the same velocity as the previously assumed rotation of the earth's crust.

At the Equator this deflecting force is greatest and at the Poles it vanishes, because the velocity of the earth's field at the Equator reaches its maximum and therefore the maximum induction or "inertia force" is produced; whereas at the Poles the rotation of the earth's field is zero, a body moving vertically either upwards or downwards at the Poles being, of course, on the axis of rotation of the field—the vector sum of the forces producing "right deflection" in the northern hemisphere and "left deflection" in the southern hemisphere.

The Foucault Pendulum is considered to give another proof of the earth's rotation.

This pendulum is given an oscillatory movement, but without any lateral swing whatever.

At the North Pole the oscillations will take place through an angle of 360° in 24 hours, that is, 15° per hour, and in any other position on the earth's surface the pendulum will oscillate through $15^\circ \sin \phi$ where ϕ is the angle of geographical latitude of the observer.

The direction of the rotation in the northern hemisphere seen from above appears clockwise, which is the direction of the earth's magnetic field.

It may be contended that the balls of the pendulum are copper spheres and that copper has virtually no magnetic properties, and that a copper compass needle would not set itself along an isogonic, all of which is true. But the cohesive force of the copper spheres is latent magnetism and the gravitational force has only one source, the central core, which is the ether magnetism from which the copper balls derive their cohesive force. Therefore, the rotating field of the earth would react on the freely swinging pendulum, and at the North Pole would rotate it through 360° in 24 hours. Whereas a compass needle of any material is not rotated by the supposed centrifugal force of the earth because its suspension does not permit it to function as a pendulum. But as the magnetic field in steel produces a permanent magnetism it reacts to the earth's field and lies statically along the isogonic.

The SP declares that the earth's gravitational force originates from the earth's centre and exerts attraction on all matter irrespective of bulk or chemical composition. Then a suitably arranged swinging pendulum must rotate in synchronism with the earth's rotating field, which obviously rotates at the same speed as the supposed rotation of the earth's crust, but in opposite sense.

Now there are two questions of outstanding importance which have not been clearly answered:

- (1) Do bodies fall towards the earth because of the earth's attraction on mass?

It may now be clear that the cohesive force of any body is itself the gravitational force in another condition. This is the only hold through which the gravitational force can exert an influence of any kind on any unsupported body. In the case of an inert body it cannot afford support, so the body must fall to a denser layer until it is suspended in free air just as a ship or floating body displaces that amount of water equal to its weight, but with this difference, that in the case of floating bodies the medium is in the second state of matter—the

liquid state—whereas in the case of the falling body the relationship between cohesive force and the earth's field is in the primary state or energy form, in which neither the hold through the cohesive force nor the strength of the field is sufficient to support the body, which must therefore eventually fall to the earth's surface.

In the case of organic bodies, such bodies have each their own magnetic stressfield and the bio-magnetic stressfield or gravitational force supports their weight within certain limitations.

A man in health does not feel his own weight when walking on the level; if he increases his weight by a few pounds (provided he is not already overweight, in which case he is not in full health) he will feel stronger. If, on the other hand, a few pounds are added to his weight through a heavy coat or the like, he will know that this additional weight has been added, because, whereas his own weight is carried or supported by his stressfield (the hold) through the earth's stressfield, the latter weight is dead weight unsupported which he himself must carry.

This support is, however, only a support relatively to the organic body itself, therefore the man as a freely-falling body must fall exactly as any other body, and for the reason already given which coincides exactly with the law or formula for falling bodies.

- (2) The second question is, do bodies or masses attract one another as is proven by the Cavendish experiment, the Eötvös Balance, etc.?

Here again, the answer is neither yes nor no, but *yes conditionally*. There are two factors governing experimental Physics—first, *the experiment*, and second, but equally important, *the deduction*. The above experiments prove that inert masses attract one another, but not the conditions under which such attraction is exerted.

It has so far entirely escaped the notice of experimental physicists that in order to perform such an experiment the whole system of the suspended bodies, either in a torsion balance or Eötvös balance, or the like, constitutes a stimulated or vibratory system owing to the method of suspension. It may be contended that this is necessary owing to the small forces involved. Granted, but this does not alter the fact that the system in each case is in a state of vibration or energy oscillation, which stimulates the cohesive force and brings about mobility through generating a field, and thereby exerts attraction. Two inert masses could not and cannot possibly exert attraction on one another unless they are stimulated.

In the case of the measurements obtained by the Eötvös balance, the masses in the earth's crust are all saturated or stimulated through the earth's all-pervading magnetic stressfield, whereas the two measuring masses or weights in the balance itself are in vibratory suspension through the elasticity of the suspending wire or wires.

Every cosmic body is not merely in a state of stimulation but has, as has already been explained, its complete stressfield of astronomical dimensions and the attraction between cosmic masses or bodies is exerted by mobile interchange of their respective stressfields, the ideal condition for stimulation, but denied to inert masses which can only be stimulated through vibratory or oscillatory stimulation of their cohesive force.

As has been stated, even radioactive materials do not deviate from this law. The reason is that their cohesive force is over-filled and thus steady radiation ensues, accompanied, however, by slow disintegration of the body as mass, but its cohesive force is still only an internal stress preserving the Space-form of the body—it has thus no external stress due to mobility. (See Appendix (7), also Miscellaneous.)

Let us, before leaving this all-important subject of gravitation, take a representative engineering example of kinetic energy and examine it thoroughly both quantitatively and qualitatively for origin-cause.

A steam locomotive is pulling a train along a straight level track at a speed of 55 m.p.h. (80 ft. per sec., approx.).

The driver shuts off steam exactly at a fixed point on the track.

What takes place now?

The train continues along the track until it is brought to rest

(a) by frictional resistance of the entire mechanism,

(b) by air resistance,

(c) by the friction between the rails and wheels.

Neglecting (a) and (b) the train will finally be brought to rest by (c).

What length of track will it cover?

What *work* will it perform?

What power will be developed?

due to this mysterious force, "kinetic energy."

Finally, what is the exact nature of this propelling force or energy known as kinetic energy? And how exactly does it produce motion, "do work" and develop power, which results in propelling the train after the motive power of steam has been entirely eliminated?

Given the following data:

$$(c) = 10 \text{ lbs. per ton}$$

$$\text{Weight of train} = 400 \text{ tons}$$

$$\text{Speed} = 80 \text{ ft. per sec.}$$

$$g = 32 \text{ ft. per sec.}^2$$

$$X = \text{distance travelled in feet}$$

$$\text{Loss of Kinetic Energy} = \text{retarding force} \times \text{distance}$$

Therefore

$$\frac{1}{2} \times \frac{400 \times 2240 \times 80^2}{g} = 400 \times 10 \times X$$

$$X = \frac{400 \times 2240 \times 80^2}{2g \times 400 \times 10} = 22400 \text{ ft.}$$

But since we have neglected (a) and (b) we may assume constant deceleration, therefore average velocity after steam was cut off is 40 ft. per sec., or 2,400 ft. per min.

$$\frac{22400}{2400} = \frac{112}{12} = 9.3 \text{ min.}$$

Therefore "work done" is

$$4000 \times 22400 = 89,600,000 \text{ ft. lbs.}$$

and this was performed in 9.3 min.

Therefore

$$\text{HP} = \frac{89,600,000}{9.3 \times 33,000} = 292$$

The amount of kinetic energy available by virtue of the train's mass and motion thus provided 292 h.p. It would not, of course, have affected the purpose for which this calculation has been made if (a) and (b) had been taken into account, it would merely have meant that the retarding force was greater and the distance travelled proportionately less—the "work done" and horse-power developed would, of course, have been exactly the same.

Now the train received its propelling force from the steam expanding in the cylinders and through a "slider crank" mechanism putting a torque on the driving wheels—the driving wheels simply constituting an infinite number of levers which function at and for an instant of time through their instantaneous virtual centres, the ever-changing point of contact between wheel and rail.

But how is the train moved, after the steam is cut off, by kinetic energy?

It is usually expressed in Dynamics: if work is done, in this case on a train, imparting motion to its mass, the same amount of work or power is available in proportion to the mass and speed.

But doing work against (a), (b) or (c) cannot make "work" or power available, as these three factors are only retarding forces; the moving train has not "stored energy" due to these three forces, it has only expended it.

Evidently the train as mass has actually "stored energy" and after steam is cut off it continues its motion along the track impelled by this stored energy, practically as if driven by some form of accumulator.

Since there is no actual apparatus in the train or locomotive capable of storing this so-called kinetic energy, this energy must have been stored in the cohesive force of the whole mass or matter of the rolling stock and locomotive.

The energy stored must therefore be that derived by "doing work" through forcing the whole mass or cohesive force of the train to cross the atmospheric stressfield—once again the crossing of two stressfields—induction taking place in the mass. The direction of induction having been given, this inductive force is now available to give or impart motion to the train but in, of course, the opposite sense to that in which it was induced and stored; as we have seen, this inductive force will bear some proportion to the mass and velocity, viz. $\frac{1}{2}mv^2$.

But where is "the hold" for this magnetic force or kinetic energy, for it is, of course, magnetic if it is obtained by cutting the earth's field?

The "hold" is on the earth's field and the train will be impelled or propelled until the accumulated induction is expended and the earth's field in the cohesive force of the train's mass and the earth's field itself have equalised out.

How is this motion actually imparted to the train?

In this case it is the body-mass of the train which imparts a motion of translation to the wheels through the axles, the wheels acting as levers as previously described. (See Appendix (8).)

PART II

THE NEW TECHNIQUE

AN ENGINEER

I possessed a passion for research—a power of suspending judgment with patience—of meditating with pleasure—of dissenting with caution—of correcting false impressions with readiness—and of arranging my thoughts with scrupulous pains. I had no hankering after novelty and no blind admiration for antiquity. Imposture in every shape I utterly detested. For all these reasons I considered that my nature had as it were a kind of kinship and connection with truth.

SIR FRANCIS BACON.

THE NEW TECHNIQUE

We have examined the Physics of the Primary State of Matter; what Matter in the Primary State signifies, its composition expressed in terms with which we are already familiar in the chemistry and physics of the present day, but establishing new nomenclature where necessary.

The principles, and finally the laws of the Primary State, have been established directly from known natural phenomena, that is the composition or texture of Space (the Ether), its functioning through polarisation of its two constituents, and ultimately the formation of a sun or other variant. Thus the origin of every heavenly body must be a "core of glowing magnetism." This is, and always must be, the seat of all gravitational attraction. A magnetic field could not and cannot exist without a source of magnetism. A solid, liquid or gaseous core could not be the origin of a magnetic field, any more than coal, as such, could be the origin of smoke. It is the energy in the coal, in the glowing state, which gives the heat that causes the gaseous manifestation known as flame, accompanied usually by imperfect combustion resulting in smoke.

Thus, all magnetism must have an origin. No solid body is itself an origin source of magnetism. Magnetite (Fe_3O_4) is strongly magnetic, but only because it has a high magnetic susceptibility—the field source being, of course, the central core, which must thus itself not only be magnetism but magnetism in the primary state of matter, magnetism as static energy. Magnetism being described as a "force of attraction," primary magnetism in the pure energy state, unbound to any form of material, must thus have the characteristic of exerting attraction upon itself, resulting in compression, implosion, and impression or form, in the glowing energy condition. The reaction must be the reverse, expansion

but as energy, in the form of radiation as a concentric stressfield, saturation from which gives certain bodies, *e.g.* magnetite, their magnetic properties or so-called residual magnetism.

The important fact from the point of view of the New Technique is that the only source of primary magnetism is a glowing core of hydrogen energy, or the primary magnetism as force is magnetism in the glowing state, or glowing magnetism, which is the Primary Force, or if we must use the present terms, the atomic force, the chemical composition of which is a hydrogen energy core interacting through mobility with its complementary cold oxygen energy stressfield, the physics of which has already been explained.

The fulcrum or basis of the New Technique based on the physics of the Primary State is thus the production of a core of glowing magnetism, the greatest available force within the reach of man, and in the Cosmos the great creative origin-force in all Nature.

In the cosmos we learned that the essential factor to the formation of a glowing core was the establishment of a magnetic point of inequality in the otherwise latent homogeneous stressfield.

Obviously, we have not the same facilities as are available in the cosmos, and so the crux of the whole problem in the New Technique is this forming of a point of inequality in the ether, under such conditions that a glowing hydrogen core, or glowing magnetism, will form as a space-form impression entity and be maintained as such.

Primary magnetism, or a glowing hydrogen core of energy, is always spherical, because it forms radially concentrically on the point of inequality.

It is therefore clear that the first technical problem we have to solve is: what form of technical appliance is there which will put a spherical stress on any given point in the ether? The stress must, of course, be magnetic or electromagnetic in quality and thereby exert a suction on the ether on and to this point, so that the surrounding ether will be drawn in, catalysed, and finally radiated out as a stimulated stressfield which can be made to "perform work" of all

kinds, just as the electric current is now used to produce mechanical power, light, heat and electrolysis for all forms of industrial purposes. There is a similar medical application to healing, radiology, diathermy and electrotherapy through ionisation of the particular salts or drugs required by any given condition of the body, and multifarious other applications. (See Part III.)

So we have now, as our guide, the fact that the appliance must be capable of continually receiving and holding an electromagnetic charge, the form of which must be spherical.

The appliance nearest to this at present available is perhaps the solenoid, which is simply a coil of wire through which an electric current is passed. The electric current produces a magnetic field round the wire coil on which the ether exerts a force of attraction or a suction force, because the ether itself is latent magnetism; and we know that if through the centre of this coil or solenoid we insert a bar of steel, the magnetic stress from the solenoid will be induced into the steel bar, and the bar will be said to be magnetised.

Suppose, therefore, we produce a magnetic field of spherical form, that is, wind our wire in the form of a sphere, and provide it with suitable support and covering.

This would hardly satisfy our requirements,

- (1) because an electric current will always have to be supplied from an exterior source;
- (2) because this type or quality of magnetic field would only magnetise a piece of iron or steel placed in the centre of the spherical solenoid and the Ether would not react to this type of gauss field;
- (3) the current in the solenoid is held adhesively to the cohesive force of the wire and cannot therefore put a stress on a point in the geometric centre of the spherical solenoid, as its complementary stressfield in this case is the cohesive force of the wire itself and it has thus no complementary stressfield or contra-pole external to its Space-form.

It will thus be perfectly clear that a field produced as at present through the medium of passing a current through a copper wire would not fulfil the purpose, and that we require some form of field which will spring out on to its geometrical centre and thus draw with it the surrounding Ether, until finally the pressure on the point from the ether compression of the constantly intruding ether brings it to the glowing state and a physical point of origin is formed on the geometrical centre of the Sphere, or, as Schappeller terms this apparatus, the Stator.

The Electret.

We have seen that the numerous so-called "effects" in Physics owe their origin to the crossing of two stressfields, *e.g.* Nernst, Ettinghaus, Hall, Ludec, Peltier and Thompson effects; these may be said to ring the changes between, say, heat and electricity, electricity and magnetism, and so forth; others have been cited, producing different effects, but all are caused by the same principle or law—*that energy can neither be produced nor transformed without the crossing of two stressfields.*

An experimental physicist once declared that he had nothing to do with the "crossing of stressfields." Neither has the housewife anything to do with the "boiling of water"; she merely places the kettle on the fire, then Nature crosses the stressfields, *i.e.* the heat stress crosses the cohesive force or stressfield of the water. This is the case in all the effects cited above; but the components, and thus the products, differ in each case.

The deeper the study of present Physics, the more this law is firmly established.

We are now about to examine another effect, which plays an important part in the new Technique, *viz.* the Permanent Electret, named thus by the Physico-Mathematical Society of Japan in 1920.

Prof. Mototaro Eguchi (Professor of Physics, Naval College, Tokyo) produced his own special electret, which constitutes really *the permanent magnet of the electrostatic sphere.*

He used as the dielectric, carnæuba wax and resin with or without a percentage of beeswax and kept it in a strong electric field, whilst slowly baking, until solidification set in. Once again we have the crossing of the two stressfields, the cohesive force of the dielectric, but this time with an electric field, aided by heat stress.

The heat stress was in a plastic condition as a slowly solidifying dielectric, and the resulting effect was the permanent electrification of the dielectric, effecting a kind of dielectric polarisation.

The nature of the electric charge produced in the dielectric is a permanent internal electrification entirely different from the superficial electrification.

For example, the electrification cannot be destroyed by different treatments applied to the surface, *e.g.* a Bunsen flame, X-ray exposure, washing with solvents, planing with a knife, or by applying electric force in any sense.

Electrification, as opposed to mere electrification, is really therefore the electrification of the whole bound stressfield of the dielectric in question.

Heaviside coined this new term "electrification" to signify an internal electrical change of a material, which is quite different from superficial electrification.

The PP explanation of this phenomenon is that the electric field is H and O energy, the stressfield of the dielectric, that is, its cohesive force or energy structure, is likewise H and O energy, and the crossing of the two stressfields brings about permanent and complete electrification of the whole mass under treatment.

It is what might be termed "occlusion," not as with gases and porous material, but "energy occlusion," made possible only by the plastic state in a slowly solidifying condition.

Eguchi declares that such an electret shows so great an intensity of electrification that the electric force exerted in front of the surface of the electret may attain the greatest sustainable value in the atmosphere—the permanency being also so good that no sensible decay was detected for three or four years after its preparation.

The maximum attainable surface densities by mechanical friction are:

<i>Rubbed on Wool.</i>		<i>Rubbed on Silk.</i>	
<i>Max. surface density.</i>		<i>Max. surface density.</i>	
Sealing wax . . .	5.70 ESU	5.40 ESU	
Shellac . . .	5.57 „	5.12 „	
Sulphur . . .	5.48 „	5.39 „	
Ebonite . . .	4.82 „	4.43 „	
Amber . . .	4.18 „	4.11 „	
Glass . . .	2.65 „	2.90 „	

whereas the Permanent Electret has densities of the order of 6 to 6.2 ESU and in air in front of surface 7 to 7.8.

The actual surface density (d) of the free charge of an electret may be calculated from observed numbers as follows:

C = capacity of the condenser system.

$$d = \frac{CV}{\pi r^2} \quad V = \text{potential read on electrometer.}$$

r = effective radius of surface induction plate,
i.e. radius of plate plus $\frac{1}{2}$ of air gap.

(For full details of Eguchi Electret see *Phil. Mag.*, 1925, 1. Vol. 49.)

Enough has been said to show that the electret is a fact established by actual experimentation, although here we are not concerned with the Eguchi electret, but merely with the principle involved and its significance, viz. the production of a *permanent magnet in the electrostatic sphere*.

This principle forms the basis or nucleus for our spherical field. Schappeller has not used either Eguchi's or any other form of known electret, and the purpose of citing Eguchi's experiments is merely to establish beyond all doubt that this principle is a practical and proven fact. The composition and preparation of Schappeller's electret, or what he terms his "sublimate," requires a special plant and involves a continuous process of perhaps six weeks' duration. Suffice it to say that the principle in the design of this new plant is "transpiration," or drawing energy from the ground by producing a stressfield above the ground

and then binding it as an energy sublimate to a suitable "electret material" to form the permanent magnet for our new form of field.

This plant, although worked out in detail, is entirely new and has no parallel in present Science; it is as important in the New Technique as the cyclotron, or equivalent apparatus, is in the attempt to obtain atomic force by the "splitting up," instead of the building up, of the atom from atomic potential in the free, unbound state, but with this difference, that once it has performed its part of producing the sublimate, it will never be required again, because the products can then be reproduced anywhere and everywhere as desired.

Magnetism.

We have already dealt with the origin of magnetism in the latent form, then polarised as vacuum or atomic force in the cosmos, and finally functioning as a sun or other variant.

We have also examined the method by which magnetism is produced and utilised in electric generators of the present day, that is the solenoid and its core; the core is then said to be polarised, and each unit of such an apparatus is termed an electromagnet. If we place a small piece of steel in the neighbourhood of the poles of such a magnet, when the solenoid is carrying the current, the steel will be attracted because the field round the end of the pole will be induced into the cohesive force of the steel and it will finally be held against the face of the core or magnet.

Or we may consider a bar magnet which has only residual magnetism, the shape of the field being so well known that it need not be shown here. The bar is then said to be magnetised; the magnetism in the bar is polarised magnetism, the one pole, as we have seen previously, is hydrogen and the other oxygen energy, the neutral centre is carbon energy, and the polariser is carbon energy in the steel.

Now there is a law in this kind of magnetism that "*magnetic lines of force are always closed.*"

This means that each line of force has N and S, or

H and O energy, and that the pull exerted is through a form of restricted mobile interchange; in other words, the field itself as such is neutral. But place a piece of steel in the field and the magnetism or static (mobile) interchange will cease and the N and S or H and O energy, the two components of all magnetism, will once again be separated out as a polarisation.

The shape of the field shows that due to compression in the metal it exerts a pressure outwards and also an attraction or pressure inwards, but only as a static field, not in the free form with true mobility.

Suppose we could bring this magnetic field to the "glowing state"; we should then have mobility, breathing, transpiration, the Primary Force. But this is not possible. We require for this an entirely new form, and an entirely new condition of magnetism, and obviously therefore a new form of magnet.

It will be clear at once that steel will not fulfil the required conditions for our new magnet.

We can even venture on a further assertion and say that no substance exists which will satisfy the required conditions for the new form of magnet or magnetic field which is an essential of the New Technique, the purpose of which is to produce the Primary Force.

Now there is polar and impolar magnetism, and we appear to require a modification, or perhaps more accurately expressed, a combination of the two.

The three essentials to any magnet are two poles and a neutral. We require a uniform, coherent and concentrated magnetism and we refer now to the magnetism itself and not to the field producing it. This is the reason that no substance of any form could fulfil these conditions, which means that our magnet must be throughout of magnetism; the two poles and the neutral must be centralised, united, in the form of the basic sign of all life force, the "trinity in unity."

But to accomplish this artificially, that is, through apparatus, the form of apparatus must be polar *and the electric current must be polarised.* The electric current is

THE NEW TECHNIQUE

self-produced in the Stator without the aid of any external generator, and is only required at all for stimulating a specially designed Rotor, not for driving it, and even then only when the Stator is required for the purpose of generating mechanical power in combination with the Rotor.

The figures show the new form of magnetic field.

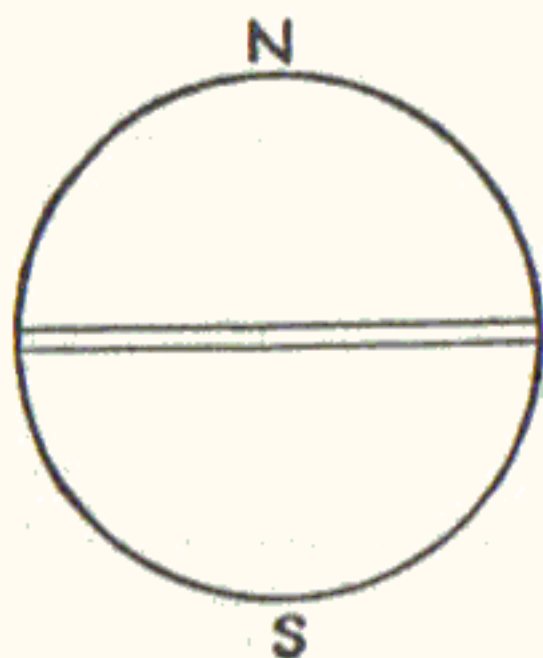

Fig. 12. External view of Stator.

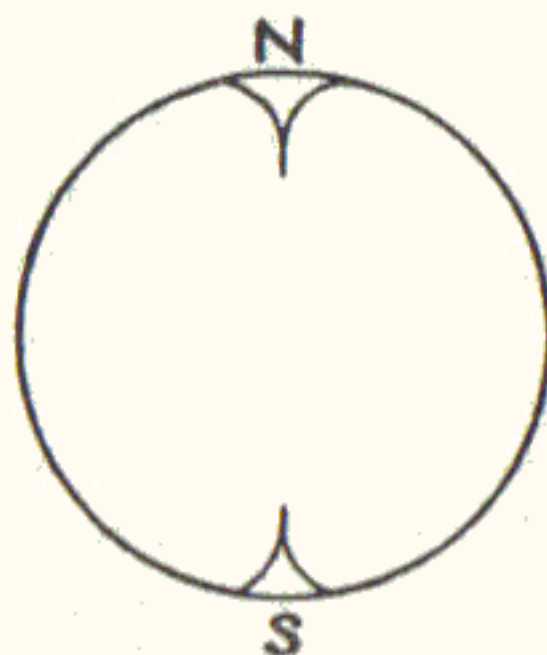

Fig. 13. Internal section of Stator.

Both are, of course, purely diagrammatic and only show the principle. Drawings are available at the end of this Part II, *i.e.*:

- (1) A Schematic diagram showing the complete circuit.
- (2) A Scale sectional drawing through the whole Stator.
- (3) A Force diagram.

There is no such thing as magnetism without the characteristic N, S and neutral, and here they meet—the trinity in unity.

So the Stator is a sphere formed in two parts—a top and bottom half or a north and south pole, both of which project into the interior of a free, hollow, central space; the diagrams represent the central hollow space of the Stator only, and not the outer covering.

The whole of the space in Fig. 13 is filled with glowing magnetism when the Stator is in operation—the glowing

magnetism being simply the induced, highly compressed energy-material; exactly as is the case with a sun or other newly formed variant.

We know from the PP that the origin of all heavenly bodies must be the Ether, being the one and only material available out of which cosmic bodies can be formed. The ether does not form a cosmic body, the cosmic body is formed out of the ether, technically perhaps a distinction without a difference, but basically one of great importance, because we are dealing here not with the dead or rather devitalised force of the electric current, but with the great biomagnetic static Primary Force.

It is the conscious sense-energy in the Ether which causes cosmic bodies to form and gives each of them their characteristic destiny to perform.

It was explained in the earlier part of this book that the Ether is latent conscious energy; the core of a sun which is out of the Ether (being merely polarised highly compressed hydrogen component, but complete with its complementary oxygen stressfield) must also be "conscious"—*i.e.* a living entity but not yet organic.

There is only one ether material, it must therefore be the same ether which is finally formed to the glowing state as glowing magnetism; only the method by which this is brought about artificially differs.

The northern half of the spherical glowing magnetism is stimulated as one pole and the southern half likewise as the other pole, therefore the diametric central surface is neutral. This trinity in unity can only exist in the pure energy state.

Three candle flames can be merged into one, but the products of combustion would be externally ejected; only their energies remain within, separate, yet united. It may be said that ten candle flames can thus be merged into one, so why call it "a trinity"?

Exactly so, but this is merely an additive process, not a basic law; the separate candle flames are in no way essential components of the whole. A single candle flame was just as complete, singly. Whereas the N and S poles and the neutral

constitute the three basic components of magnetism, without which no polarised magnetism can exist.

It may be asked, then, where is the neutral in the latent magnetism of the ether? It has, however, previously been explained that the N and S poles are the H and O components and that the neutral is the carbon before polarisation and this is the unity in the trinity.

Exactly the same exists here from this artificial polarisation, the carbon neutral being, however, merely in this case a Euclidian diametric surface as homogeneity exists throughout.

We have dealt at length with the comparison between Primary and Secondary or Steel magnetism; now let us compare the form which each of these magnets takes in actual practice.

It is obvious that innumerable questions arise, which require an answer, but let us clear them up one by one without haste and thus without confusion.

The study of "origin" requires not only immense patience and a restful mind cleared of prejudice, but also great tolerance, before it can be intelligently assimilated!

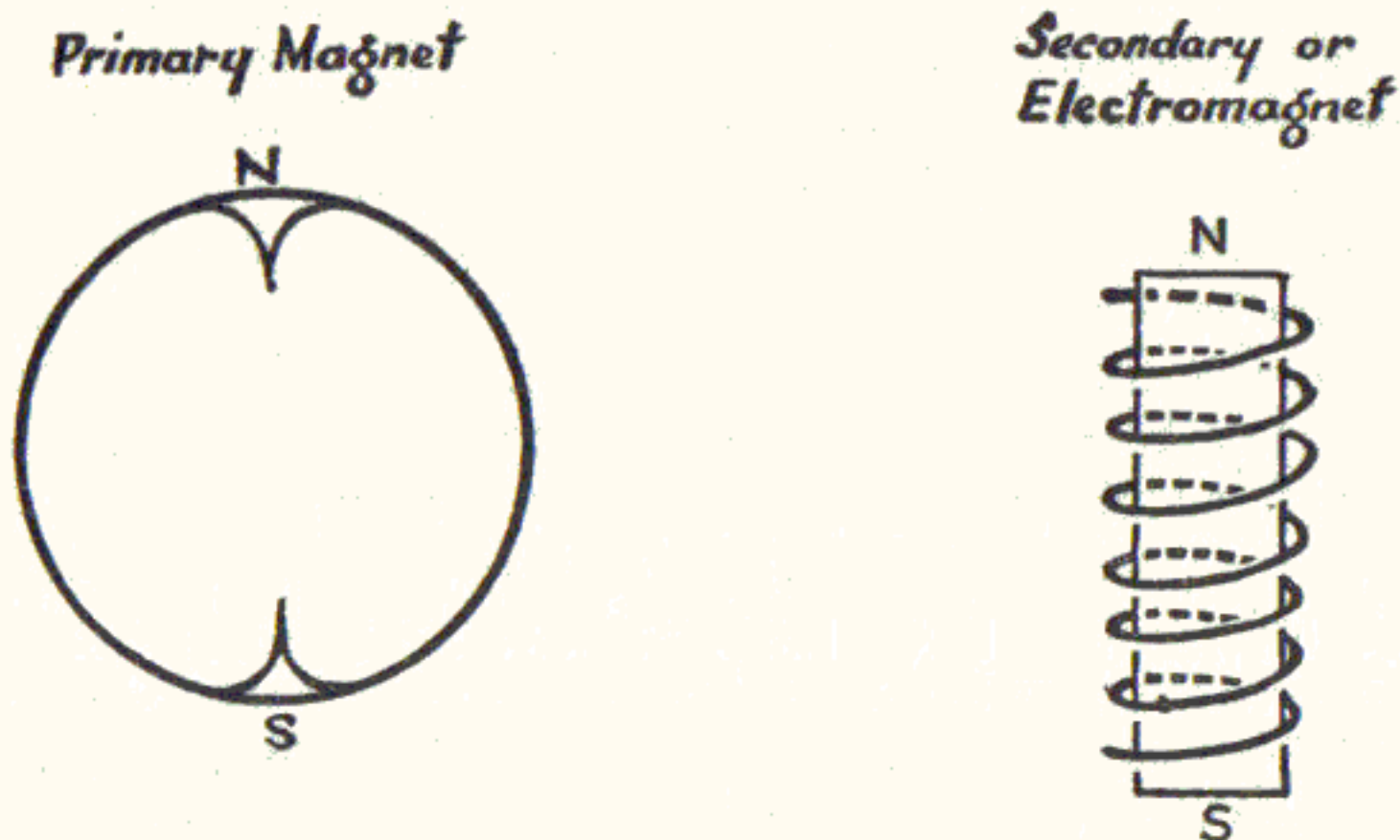

FIG. 14

Poles pointing inwards.
Windings internal.
Field internal.

Poles outwards.
Windings external.
Field external.

The bare statement has been made that the glowing magnetism forms in the central hollow space of the Stator, which merely explains what this central space is for, and that in being the seat of the glowing magnetism it is the purpose for which the whole Stator is designed.

The purpose for which a gun is designed, complex mechanism as it is, is nevertheless merely to fire a shell; and the purpose for which this new apparatus, the Stator, is designed is solely for the production and maintenance of a glowing magnetic core, which we now see is formed and maintained in this central hollow space.

The questions now arise, how and when is the glowing magnetism formed and maintained? We now know where this takes place.

As we already know, the first essential to its formation is *to produce a point of inequality in the homogeneous ether, in the geometric centre of the hollow space, in order that a physical centre may be formed.*

But we have not the facilities of the Cosmos, and so we can only accomplish this by setting up a magnetic field which will concentrate a pressure on the centre of the hollow space; but this must not, as we have seen, be a gauss field.

The coils instead of being wires must be tubes, or if we prefer the term, tubular wires, as they are of very small diameter,—perhaps of the order of, say, $\frac{1}{4}$ in.

Of what substance should these coils of tubular wires or tubes be made?

In this form of electromagnetism it may be said that a conductor is an insulator and that a dielectric holds a charge, and in one sense for static electricity it is thus, as it were, a static conductor. So our wires or tubes would be made of copper. The production of such small diameter copper tubes was the only important mechanical difficulty which the working out of a very complete set of elaborate drawings and designs revealed. Needless to say, Schappeller and Joseph Schappeller, his adopted son (a mature and qualified electrical engineer of Vienna), set themselves the task of finding out definitely whether the manufacture of such tubes would present any mechanical or manufac-

turing difficulty. The result of this enquiry was that such tubes were already being manufactured in Austria for another purpose and the manufacturer sent samples which the author was able to examine.

The drawings for the Rotor have also been worked out and the author is able to state that no further mechanical or electrical difficulty presented itself in the design of either of these two entirely separate units, which together constitute the complete Prime Mover for the production of mechanical power in the New Technique. Furthermore, the Stator, when suitably designed, can be used for the production of light and heat, of course without a Rotor (which latter would obviously only be required when the purpose was the production of power), and likewise for many other purposes including radiology in the treatment of diseases, etc., etc.

But hollow copper wires or tubes alone will not enable a suitable magnetic field to be produced. The purpose of hollow tubes is to fill them with a suitably chosen and suitably prepared combination of substances, the actual composition and preparation of which is Schappeller's secret. It is the equivalent of Eguchi's Electret, but whereas Eguchi's Electret was in the nature merely of an experiment in Physics to establish a phenomenon or "effect," Schappeller's sublimate is the outcome of experiment guided by immense original research relevant to the various specific purposes for which this sublimate is to be produced.

The new plant for the production of his sublimate is entirely of his own design, based on a deep knowledge of the application of the laws of the Primary Physics, but presents no constructive or mechanical difficulties, and brings the production of the sublimate to a fine art. The general principles of the design of this plant and apparatus are known to the author, but it would not be legitimate for him to reveal them here, and it is furthermore unnecessary at this juncture.

That a sublimate can be produced is a proven fact from the Eguchi experiments.

Quality of Energy.

Now before we leave the subject of the sublimate an important question arises: why will not any sublimate serve the purpose? This, in the New Technique, opens up a large new field as yet entirely hidden from Science—"quality of energy."

Some scientists are trying to begin to think in terms of quality of energy, but for them at present no such thing as quality of energy exists.

As was pointed out in an earlier Chapter, the transformation of the sun's electromagnetic radiation into light and heat on this earth does not mean that light and heat are different qualities of energy. How could they be, since they are from the same source. They are merely *different conditions* of electromagnetic radiation the quality of which was characterised by the sun.

We can have different qualities of coal gas, because it is merely a mechanical mixture suitably adjusted for various purposes—light or heat; but there is no such thing as different qualities of steam—saturated and superheated steam are different conditions, not different qualities, as both owe their origin to water.

In the case of the electric current or a magnetic field derived from it there is neither a change of quality nor of condition, only of form, *e.g.* DC or AC current and various forms of fields.

To produce magnetic fields of different qualities we require a sublimate and the quality is, of course, characterised by its specific composition; herein lies the immense importance of the sublimate, and that is why Schappeller has reduced this portion of the work to a highly developed art. In view of the evidence given of the Electret there appears to be little reason to doubt that he can reproduce this in special forms to suit the innumerable conditions demanded in the application of his New Technique.

The quality of energy required for mechanical power is obviously different from that required for specific purposes in radiology, although the radiation even from a power

Stator would be generally beneficial to the human body, as both the Stator's energy and that of the human body are biomagnetic.

We are, however, at present simply concerned with the design of a Stator for the production of mechanical power. We will now assume that the correct composition of sublimate has been prepared; it is then forced into the two coils of tubing (that is, the tubing which is to constitute the N and S poles, or two halves of the Sphere or Stator) until the tubes are completely filled throughout.

These tubes are now embedded in a suitable material of ceramic composition which, when it cools and solidifies, holds the two coils firmly in position. This ceramic material performs various functions; it holds the tubes in position, protects them, refines the ether radiation or induction into the centre, and its inner periphery or surface presents a heat-resisting face to the glowing magnetism. It is also electrically an insulator.

The Charging of the Sublimate.

The sublimate must be charged with electric current, after which, provided no power is taken from it, it will retain its charge as we saw in the case of the Electret; the sublimate in this case is an energy sublimate (produced by the new plant referred to above), but this sublimate is bound to a composition of substances in the solid form with which the tubular coils are tightly filled.

The charging plant required is merely that necessary to give the required number of ampères, the plant being composed of the requisite generators and units, according to whether the grid current is available or an entirely different supply is required, or both as a "standby." Such plants will, of course, supply direct current.

The Stator.

A ceramic lining or casing is fixed on the inside of a steel casing, the whole being on two journals supported on trunnions.

A lever with handle is connected to one side of the trunnion outside the journal, by means of which the Stator's

sphere can be tilted from the position of N-S vertical to the limiting angle required for directional magnetic concentration on the Rotor, as we shall see later.

The Circuit.

Starting from the top half of the Stator, the coil of tube containing the sublimate is fixed to the North Pole, finally emerging on one side through the hollow axle on which the Sphere of the Stator is supported, the bottom half of the Sphere being similarly provided with a coil of tube attached to the South Pole and emerging on the other side through the hollow axle.

Wires (ordinary copper conducting wires) are connected to the two ends of the nests of tubes, after which they emerge through the hollow axle and are brought down to two terminals conveniently situated. These wires complete the circuit through the Rotor, which is mechanically an entirely separate unit, standing on its own base and at a specific calculated distance from the Stator; the Rotor is fixed to the shaft to be driven.

The central terminal is for the "earthing connection" through a battery (needless to say, of special design and having no relation to any form of battery at present known to the SP), and the Sphere is earthed through the battery—the whole of this connection from the centre terminal to the "earthing disc" itself being a tube filled with sublimate exactly similar to the tubes forming the Stator field.

The disc or earthing plate is also of special design, according to the purpose to be served.

The battery is not essential where the Stator is merely for the production of power, as it is really a refining apparatus—that is, for refining or qualifying the energy for each specific purpose to be served.

A study of the Schematic Diagram and Scale Drawing of the Stator should now make this clear.

The Rotor.

This is really a steel wheel of special design fixed actually on the shaft to be driven. And here is a point the significance of which is worthy of a short digression.

It has often been contended that even if the New Power can be produced and the first application to the production of Mechanical Power is successfully proven, it would probably take, say, a quarter of a century to bring it to a high state of perfection; the development of steam, Diesel engines, electric generators and motors, took several decades, steam perhaps a century.

Now there are several answers to this:

(1) Suppose it did require several decades to perfect it, what objection is there? If steam, Diesel and other prime movers were worth it, why is not the Primary Prime Mover and its countless other applications worth it also, seeing that in the case of its application to the production of power no fuel, as such, is required? Is this not rather an important point, since scientists and engineers have worked and are still working patiently and unceasingly to reduce the fuel bill of present prime movers by even a small percentage, when here there is no fuel bill—the other applications of the Primary Force, moreover, being entirely beyond the accomplishment of the secondary forces at present in use.

(2) The more the laws and their application are understood, the quicker the development—steam took about a century to reach its present stage, but the Diesel engine only about a quarter of that.

(3) Why are the above techniques so complex, and why do they find their application in such complex mechanisms? Apparently no one troubles to consider such questions. The answer is exactly because a secondary, instead of the Primary, force has been employed. Take large modern marine Diesel sets. How many parts do such plants comprise? The author does not pretend to know, but it has been suggested about 1,000 parts, each. Be this as it may, the new Prime Mover has no moving

parts at all, for this very reason that the Rotor is actually part of the shaft to be driven. There are therefore no innumerable sets of bearings, valves, gears, delicate mechanisms and superaccurate pumps on which the functioning of such immensely complicated machinery depends.

(4) What is the total cost of the development of the steam technique during the past century or of the Diesel engine in the last twenty-five years throughout the whole world? How many countless millions have been spent? Also, what is the total fuel bill of all the steam and Diesel engines operating throughout the whole world, say, per day?

These are the questions which should be asked.

But to return to the construction of the Rotor. This consists of a steel wheel of special design with short spokes, and, finally, a periphery or rim in which there are magnets—always an odd number, five or seven and so forth, to avoid the possibility of a dead centre.

This has been worked out in detail just like the Stator, but the author regrets that he has no drawing of the Rotor available at present.

The body, spokes and part of the periphery, including of course the magnets, which latter are also hollow, are entirely filled with sublimate and energised through the electric current, as shown in the Schematic Diagram, the moment the Stator is switched on.

“Switching On.”

What actually does “switching on” mean?

It means “earthing” the Stator. In the “off position” the earthing connection D_1 is broken, the Stator or Sphere of the Stator being exactly in the position of N-S vertical. So switching on means pulling the lever provided on the Stator spindle and thereby taking the Sphere of the Stator off the neutral stud; the Sphere is then earthed through the connections shown and “aired” through the N pole at the top, which may even culminate outside the Sphere in a cross

filled with electret or sublimate material, or in a Sphere, in place of an ordinary screwed plug. (See drawing of Stator.)

The complete theoretical energy cycle is shown in the Schematic Diagram. The dotted line represents the return to the earth, really a theoretical consideration.

The position of the Rotor relatively to the Stator is the position of the reader when studying the drawing. If the reader pulled the lever towards him the N pole would finally point exactly to his eyes. Imagine that his eyes are a magnet just appearing over the top of the Rotor periphery. The Stator in this position, will be exerting its maximum force on the Rotor, because half the core is concentrated on the Rotor.

The Rotor will be set with its axis, that is, the axis of the shaft to be driven, parallel to the axis of the Stator shaft through the trunnion, and at any convenient distance within the Stator's amplitude; Schappeller declares that a suitable distance between the shaft of the Stator and that of the Rotor is seven times the outside diameter of the Stator ($7d$).

Force exerted by Stator on Rotor.

Referring now to the Force Diagram, the dot and dash line XX represents the centre line (in a horizontal plane) of the Sphere of the Stator through the journals and trunnion. The line (dot and dash) YY is the centre line through the vertical plane. The line (dot and dash) Z is the centre line through the Stator Sphere and centre line of peripheral circle of magnets, tangential to the radius of the Rotor at this circle.

The distance between centre of Sphere and centre of magnet appearing on periphery of Rotor is $7d$ (see Fig. 15).

The force or pull exerted by the Sphere (Stator) on the Rotor periphery will bear a definite proportion to the angle at which the lever is placed with relationship to the YY axis.

Line A_2B_2 represents pull for lever at 10° .

„ A_1B_1 „ „ „ „ 30° .

„ AB „ „ for maximum position.

The above, of course, are the rectangular projections

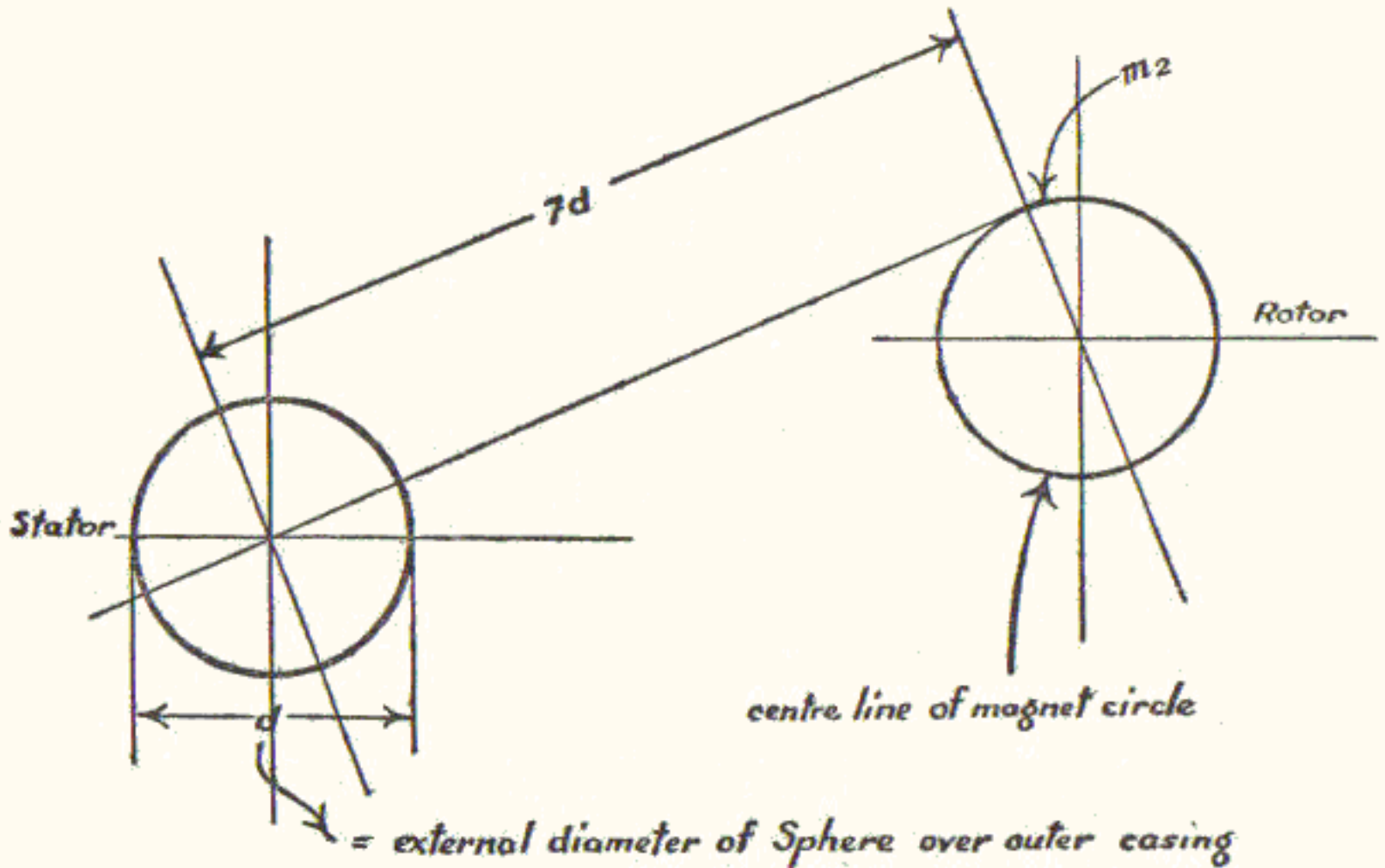

FIG. 15

of the N pole, or a graphic representation of the useful component of force directionally available for exerting a pull on the Rotor.

The Z line is the position of the lever for maximum force.

The Rotor for the first demonstration has been designed for 15 HP only, but with the present Stator dimensions, so that enormous surplus power is available.

There will be a demagnetising or "braking" effect on that portion of the pole not in mobile exchange with the Rotor, which at AB max. will be zero, at A_1B_1 (corresponding to a lever position in the diagram of 30°) is represented by the smaller area and sloping section lines, and at A_2B_2 (for lever at 10°) is represented by the larger area shown by vertical section lines. The value of these two braking effects is represented by the projection of B_1A_1 and B_2A_2 , respectively, to the limiting lines A0.

This theoretical diagram would be modified when set out for any actual Prime Mover:

- (a) by the relative positions of Stator and Rotor;
- (b) by the diameter of the Rotor magnet, represented here as a point.

Let us now obtain through calculation some impression of the maximum directional force exerted by the Stator. We must remember that this is not "steel magnetism," but magnetism from a glowing core in the primary state, for which the known laws of magnetism will be modified.

Coulomb's law $F = k \frac{m_1 m_2}{r^2}$ is not in a convenient form to make the first calculation; we will therefore use the form

$$F = \frac{B^2 A}{8\pi}$$

Now, if we are, with this form of primary magnetism, within the amplitude at $7d$, it is legitimate to make a preliminary calculation based on this formula, if only to demonstrate the principle on which the force is exerted.

Remember, in this connection, that here it is the electricity that is stationary and the magnetism that is radiated, as we shall see shortly when we examine the functioning of the whole Stator and Rotor.

The next consideration is the introduction of the Schappeller constant.

He derives this on the principle that water is to air as 1000:1 (as weight or density), and that air is to atmosphere (as stressfield) as at least the same, 1000:1. Therefore the expansive power of the ether is at least 1000 times that of air and likewise of a present gauss field, whose expansive power as a field is negligible, relatively. In other words, the capacity of the ether for stimulation as a stressfield, for all practical purposes, is infinite, and the force inducing ether stimulation has its seat or origin in the magnetic-heat potential, *e.g.* the sun's magnetic-heat potential and its infinite stressfield.

So Schappeller takes as his constant that this primary magnetism is 1000 times more powerful than a magnetic field of present magnetism—a gauss field—which, when the full significance of a primary stressfield and its origin-force has been assimilated, may be regarded as quite a moderate figure.

It may be said that the field from the earth's core,

which is, of course, also glowing magnetism, is only 981—yes, but if we take the present estimate of the core at 2000 miles radius, this flux of 981 is for a distance of 2000 miles.

Calculations on the Stator.

Given a Stator Sphere of 15 cm. diameter, what HP is available?

Take B for steel at a flux density of 15,000 gauss (Maxwells per cm.²).

A = surface area of Sphere = say 600 cm.²

$$\begin{aligned} \text{Then } F &= \frac{B^2 A}{8\pi} = \frac{15000^2 \times 600}{8\pi} \\ &= \frac{225 \times 10^6 \text{ dynes} \times 600 \text{ cm.}^2}{25 \times 981 \times 1000} = 5400 \text{ kilos pull} \end{aligned}$$

exerted just outside the surface of the Sphere.

But we must now introduce Schappeller's constant 1000. The author halves this again and calls it 500—a very low figure.

Therefore Pull = 2,700,000 kilos,

But only half the Sphere is directly or directionally active.

Therefore Pull = 1,350,000 kilos, say, 50% efficiency between field of Stator and field of Rotor—loss due to slip, not heat. (See Chapter XXIV, p. 172, para. 2.)

Thus Pull = 675,000 kilos.

Take this as operating at 1 metre per sec. and we have

$$\frac{675000}{75} = 9000 \text{ HP}$$

which is the same figure as that which we obtained from the Mathias value of lightning-material. (See Chapter on Lightning.)

Now, Physics tells us that the earth's field varies as the square of the distance from the centre of the earth, but that the earth's core has probably a radius of 2000 miles. Therefore the crust is 2000 miles thick.

THE NEW TECHNIQUE

The PP establishes the earth's core as glowing magnetism; therefore this 981 is at 2000 miles.

But 77 miles is about the 26th part of 2000 miles, and the square of 26 is 680 approx.

$$680 \times 981 = 675,000 \text{ approx.}$$

Therefore, on this calculation the earth's field would have an equivalent force or exert an equivalent pull to that exerted by our Stator at 77 miles from its core periphery.

If we make the calculation from the geometric centre of the earth on a radius of 4000 miles, instead of 77 miles we should have, say, 150 as the equivalent distance for the earth's field to exert 675,000 dynes per cm.², which, as the core itself is 2000 miles radius, is *reductio ad absurdum*. This shows that we are well within the estimate for the force exerted by primary magnetism from a glowing core.

The earth's field is, of course, vastly greater than that of our Stator, so much greater that on this calculation it has a magnetic field at 77 miles from its core periphery equivalent to the field produced by our little Sphere at a distance of, say, 1 metre from the Stator core.

The actual pull exerted on a magnet on the Rotor periphery depends on the intensity of stimulation given to the Rotor magnets, and may, for the examination of the principles, be represented by

$$F = k \frac{m_1 m_2}{r^2}$$

where m_1 is the Stator field and

m_2 the field of any given Rotor magnet.

As regards the actual power to be transferred to the Rotor, we have three adjustments available:

- (1) The strength of the Stator field, which must have a minimum strength sufficient to bring the Ether concentration to the glowing state.
- (2) The resulting pull exerted on the Rotor, according to the position of the lever as shown in the Force Diagram.

- (3) The stimulation given to the Rotor magnets through the electric current generated in the Stator. This will be direct current, the strength of which can, of course, be entirely controlled through the present known means.

It will be obvious that more data is required to make the actual calculation, *e.g.* a "constant of stimulation" will have to be introduced depending on the composition of the secret sublimates, and there are other considerations.

But let us now again make a calculation of the available HP from the Stator, but on quite a different basis. We mentioned in one of the earlier chapters that this might bear some relationship to Electrochemical Equivalents.

Now with electrolytic action:

1 amp. deposits 0.329 mgm. of copper per sec.

3 amps. deposit 1.00 " " " "

Now each 8.9 gm. " " occupies 1 cm.³

But 1 litre = 1 dm.³ = 1000 cm.³

There are thus, say, 9000 gms. of copper in 1 litre.

So in a 1 litre Stator we have 9000 gms. of copper or

$$3 \times 1000 \times 9000 = 27 \times 10^6 \text{ amps.}$$

Assume 1 volt and

$$\frac{27 \times 10^6}{746} = 36000 \text{ HP}$$

But maximum available at 50% for half the Sphere is 9000 HP, as was obtained in the last case by the Mathias figure. (See Chapter on Lightning.) This must be regarded as taking place within a second, because the deposition figure is per sec. per ampère; this energy is, however, instantly available.

It should, nevertheless, be realised that this is an energy-capacity measurement, whereas the resulting stress-field is per unit surface, a surface measurement. The capacity measurement is "indication" and thus we cannot multiply by the Schappeller factor here.

Now, it may be said that 1 volt would not bring the Ether to the glowing state, which is perfectly true, although this will be made clearer shortly.

In the energy form or state we may assume a high "transference or conversion efficiency." The commercial efficiency is, of course, about 100%, because the fuel costs nothing and is inexhaustible.

The earth, as has been previously explained, is the storehouse of energy, which energy is available to replenish continuously the Stator Field as and when the Rotor draws energy from the Stator through the medium of the energy cycle.

Electropy then ensues promoting continuous induction of the Ether towards the centre, just as it takes place in the sun through the induction of its complementary stressfield; but here, through the pressure exerted on the hollow centre of the Stator due to the intensity of the Electret or sublimate field.

It was explained in the Chapter on the Electric Current that amps. are merely densified volts, and this must be so because an inspection of the basic formula or Ohm's law shows that the power is obtainable from any given electric current in direct proportion to the product of volts and amps., volts representing the stress or energy potential, and amps. per unit of time being the quantity—the actual unit being the Coulomb.

The best illustration of this in the electrotechnique of the present day is perhaps the transformer, which actually converts volts into amps., or *vice versa*. It follows that what we are doing here is merely to convert volts into amps.

The volts in the sublimate through electrization constitute the static electric field, which field is constantly concentrating its energy on to the centre point of the Sphere and densifying, or sublimating, because amps. are really a sublimation out of an electric stressfield produced artificially by compression of the cohesive force in the space-form of a wire.

In the present electrotechnique volts are densified to amps. through compression in a wire, the denser amps. requiring a larger section for their accommodation, that is, the sublimate, being energy-material, requires more space than the stressfield from which it originated, hence the

larger section required in the secondary winding of a transformer in "stepping down."

In the New Technique all this takes place in the free state, through compression on a centre, till densification brings about ignition and we then really have amps. as the glowing core surrounded by its complementary volt-stress-field which together, in this form, constitute the true atomic or Vacuum Force.

But we saw in our previous calculations that the Stator had a calculated capacity of 36,000 HP or an effective maximum capacity of 9000 HP.

Let us now work backwards; assuming that the full capacity of the Sphere is used, which it never would be, because of engineering considerations, the Stator must be capable of supplying 36,000 HP continuously.

The primary static charge on the field must be only of such capacity that it will occasion induction of the Ether and in the initial stage cause implosion, and afterwards sustain this densified Ether in the glowing state to the capacity of the load when connected between the PD earth-atmospheric stressfield.

But if the Stator is to be loaded to its full capacity, which we have seen is calculated for practical purposes as 9000 HP (effective), then 36,000 HP of energy must be drawn from the earth.

Now let X = the amps. charge required by the field

then
$$\frac{500 \times X \times 100}{746 \times 9000} = 135 \text{ amps. at 100 volts}$$

or let us say 13,500 watts, which is converted into glowing energy 500 times as powerful (taking a value of half Schappeller's constant).

This really signifies that the Stator field must be able to hold or transfer 13,500 watts per min., which, as has been explained, is actually supplied or drawn up from the earth through the earthing connection shown in the drawing and diagram. The voltage required for the charge is only that necessary to impress the charge into the sublimate.

THE NEW TECHNIQUE

After electropy has taken place there are, speaking the language of the present electrotechnique, no volts in the actual core, as they are densified to amps. Hence we say 1 volt for purposes of calculation.

Thus the capacity of the field in any given design depends on:

- (1) the rate at which power is to be drawn;
- (2) the total effective area of the nest of tubes, which may have three or four rows, arranged concentrically as one continuous field.

The designs and drawings which have already been prepared are actually for a 15 HP Prime Mover, the Stator being of the dimensions given in the calculation. So that instead of supplying 9000 HP it has in the first demonstration only to supply 15 HP.

The above calculations are thus only intended to show the function which this type of field has to perform.

The 15 cm. Stator is about the smallest that it is mechanically practical to produce.

Here, it should perhaps be made clear that the cost of a complete Prime Mover (Stator and Rotor) is negligible. The main cost of demonstrating the application to mechanical power lies in the purchase of the charging plants and standby sets, which latter are absolutely necessary for certain reasons, and also Schappeller's special plant for the production of the initial sublimate by occasioning transpiration, followed by condensation and sublimation, all in the energy form.

Let it therefore be clearly understood that any suggestion of small laboratory models or the like is out of the question or they would obviously have been used and the application of the Primary Force to mechanical power would long since have been tested out. The transpiration could not be produced by models and the essential sublimate could not therefore be produced except by a plant of certain minimum dimensions capable of producing transpiration, and this also applies to the Stator and Rotor which is obvious here when the design of the Stator is carefully examined.

The Functioning of the New Prime Mover.

From a careful study of the Force Diagram it may be said that a very small initial movement of the lever represents an inconveniently large "available force," but the diagram also shows, in relation to this, that the "braking effect" at small angles of movements of the lever is much greater than at larger angles, as shown by the cross-hatched and hatched areas; and if the two units (Stator and Rotor) of the Prime Mover are carefully designed, and set for the average and maximum loads required in each case where such Prime Movers are to be installed, the "graduation curve of force" relative to lever angles can be favourable, within the ranges of power required in each particular case.

It will thus be seen that there is a *characteristic curve* for this, just as there is for every motor or generator in the present electrotechnique; or it is perhaps the equivalent of the Zeuner diagrams for reciprocating steam engines.

For the moment, however, we are not concerned here so much with the design as with the actual functioning of the Prime Mover.

We have seen that whichever way we make our preliminary calculations for estimating the power available, the power exerted on the Rotor is in the form of a pull as between the poles of two magnets. It is, however, from the mechanical engineer's standpoint, somewhat doubtful whether this force exerted as described here would prove to be an entirely satisfactory method of producing mechanical power, but happily this point is of little or no importance, as it is not the way in which the rotary motion is produced. The pull exerted on the Rotor magnets gives the Rotor periphery its *directional motion*, but the motion is afterwards sustained or maintained by the crossing of two stressfields, *i.e.* the Stator stressfield crossing the stressfield of the Rotor—the means by which the earth gives the sun its rotation on its axis. In other words, it sets up a condition of dynamic balance, or an *equilibrium which can only be satisfied by producing the requisite motion.*

THE NEW TECHNIQUE

The sun is a product of the earth's stressfield and is thus biomagnetically characterised by it and to it.

Likewise, in the case of the Stator and Rotor, the Rotor being energised entirely—both qualitatively and quantitatively—by the Stator, rotary motion is imparted and maintained in the Rotor provided always that directional pull has been given, and here it is also sustained, *i.e.* the direct pull on the magnet.

In the case of the earth and sun we have motion imparted and sustained in the latter's core of glowing magnetism, which is crossed—and thus energised and characterised—by the earth's stressfield, whereas with the Stator and the Rotor we have artificially not exactly a similar, but an equivalent condition, viz. we have set up in a Rotor an energised field stimulated and characterised from a given Stator, but here, since the Rotor field is in the cold condition and the Stator field, although exactly similar in quality, is in the glowing or hot condition (energy form), a magnetic-heat potential exists between the two units of the Prime Mover.

This is a striking example of the Schappeller discovery shown graphically in the first of his symbols in Chapter VII,

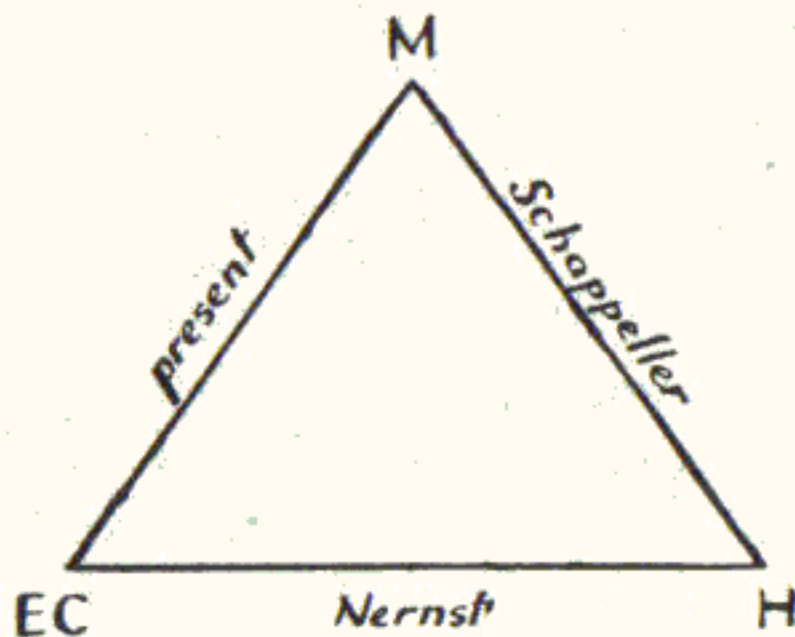

FIG. 16

viz. magnetism and heat as one, which does not exist in the present Physics, that is, magnetism with heat-potential, the source of the greatest force which exists in Nature.

It is for this reason that the whole body of the Rotor with its spokes, in addition to the actual magnets, is filled with sublimate and energised through an electric current

generated directly in the Stator itself. Directional pull is then given directly on the peripheral magnets and the whole energised Rotor is then cutting lines of force at a speed determined by the magnetic-heat potential and the load, adjustable as follows:—

- (1) By the strength of the current supplied to the Rotor sublimate being variable as in the present electro-technique.
- (2) By the Stator field heat-potential which, according to Schappeller, may be of the order of 50° – 300° C., whereas the Ether or cold latent magnetism will always be constant, probably as low as -270° (more or less) even near the earth's surface. The intensity of the field and heat-potential will vary with the initial charge given to the sublimate.
- (3) By moving the Stator lever and thus altering the angle of the N–S poles in the Stator Sphere with relation to the rotary periphery.
- (4) By adjusting the relative positions of Stator and Rotor. Stator N–S line need not be vertical when on the neutral position.

The Rotor is laminated to prevent eddying and the magnets do not project; the Rotor periphery is thus entirely equiradial. The Rotor is fixed to the shaft to be driven and the Stator is fixed about a metre above the earth's surface. This latter is, of course, flexible because the earth can include the sea or even the floor of an ether-ship.

From one standpoint the Stator may be regarded as a body in Space. The concentration of the ether or latent magnetism takes place over the entire surface of the Sphere, in the same way as in the case of the earth itself. It represents as it were a "power-field" concentrating on the central point of the Sphere. But actual concentration will take place only if, and when, a potential difference exists between the density in the latent magnetism outside and inside the Sphere cavity, which again will depend on the existence of a heat-potential.

When the Sphere cavity is full of air the ether density will be balanced, and this is, of course, the position when the lever is first pushed off the stop or neutral position.

A power field therefore exists outside the cavity (or hollow centre of the Stator Sphere) which is ever ready to concentrate with tremendous energy or atomic pressure at the centre point of the cavity the moment a heat-potential exists or is produced.

Now, the instant the lever is pushed off the neutral point to the Star Sphere is polarised, or possesses an N and S pole although the N and S line may only be a few degrees out of the vertical neutral position. The Force Diagram is set out for the vertical at the "neutral position" but it need not be.

The field is energised the moment the Stator is switched on. The ether balance inside and outside is no longer stable; pressure due to the field is exerted on the centre of the cavity, and a stream of cold latent magnetism (or ether) flows from the N to the S pole, the only pathway at present available as the air is still in the cavity.

An ever-increasing pressure from the field concentrates on the centre and the air (which is merely a sublimate out of the ether) is disintegrated; that is, the nitrogen and residue (the noble gases) are re-converted into the energy form as hydrogen, and the oxygen to oxygen energy, in other words, the whole is re-converted into ether and concentrated.

The now powerful concentration of the field on the centre of the cavity, after removing the air, induces an inrush of ether through the entire surface of the Sphere, resulting in a tremendous concentration of ether in the cavity. The pressure increases until finally the whole ether mass reaches a density corresponding to a critical temperature above which this densified ether enters into the glowing state and a powerful heat-potential is established.

But it will be clearly understood by now that this is not merely heat-potential such as operates a thermodynamic cycle, but a magnetic heat-potential due to magnetism as densified energy in the glowing state.

In the Chapter on the Electric Current the formula

$$\text{Current} = \frac{\text{gauss}}{0}$$

was given as being the equivalent of Ohm's law for the production of electromagnetism by the new Primary Technique, and the significance of the factors in this formula can now be understood.

$$C = \frac{\text{gauss (vacuum)}}{0}$$

C = current, but current as such does not exist in the Primary Technique because, as we know, here the electricity is static and the magnetism moves—hence the term dynamagnetism.

C in the Primary Technique thus signifies not current as such, but its static equivalent, viz. densified volts, or amps.

As has been explained, the BEMF is lifted and becomes the surrounding stress designated in the formula as the field under the term *gauss*. Here, however, this does not mean merely the field produced by the sublimate as such, but rather the complementary other half of the glowing magnetic core or ether concentration as volts. The two, *i.e.* glowing core (amps.) and complementary stressfield (volts), constitute (as in the case of the sun and its complementary stressfield) a primary vacuum—hence the word *vacuum* in brackets next to gauss.

Now this concentration of the stressfield is virtually on one point, which produces and sustains a physical centre.

The Euclidian definition of a point is that it has no magnitude, so mathematically its dimensions are zero or 0, and C is therefore (theoretically) infinity.

The reason that it is not actually infinity is because of the limitations of "form" due to the construction of the apparatus. The sun's resultant field is so vast that it may be termed, for all practical purposes, infinite in extent.

We have thus constructed artificially an apparatus which will *set up the conditions* in which Primary vacuum

THE NEW TECHNIQUE

will form and be maintained or, speaking technically, an artificial sun and its surrounding stressfield. This is the biomagnetic static force, *the atomic force*, for which scientists are researching, but in its free original state as a potential difference by the building up of the atom, instead of endeavouring to obtain this force in its secondary form, where it appears as Cohesive Force in material, and then attempting to split it up, when it is neither collectible nor biomagnetic but devitalised.

It should be clearly understood that it is impossible for any apparatus to produce glowing magnetism, just as it is impossible for any kettle or boiler to produce steam; *such apparatus can only be constructed to bring about the conditions in which these phenomena will obtain.* In purely colloquial language it is, of course, exactly the same thing, but speaking strictly scientifically it is very important to keep this clearly in our minds.

But to continue with the Technique. This glowing magnetism in the central cavity has not merely enormous suction force, in that the surrounding ether concentration is induced into it through and by the powerful field concentration on the centre point, but it acts as a catalyst, that is, it catalyses the carbon energy static (the Ether) and compresses it; the reaction must therefore be the opposite—expansion—and it is thus radiating it out as a stimulated (instead of latent) H and O power field, or true bioelectromagnetic radiation or stress.

It draws between the potential difference earth-atmosphere (as a stressfield)—this is the PD—but the reservoir of energy from which it draws is the biomagnetic saturation of the earth (H and O energy) which the earth derives from its central core, hence the imaginary dotted line in the Schematic Diagram showing the return of the fundamental energy cycle to the earth's central core, in principle.

The actual suction exerted to supply the energy taken from the Sphere by whatever load is being carried (the load need not necessarily be mechanical power—it may be reproduction of primary light or heat, curative radiation, or the

production of one of the essential elements, or for various other purposes) is drawn up through the earthing tube as dynamagnetism, and this energy travels up this tube into the Stator field on the "energised sublimate" and is then projected out of the spherical field by Electropy, due to the central pull exerted on the spherical field by the physical centre or core caused by the load.

The suction exerted by the glowing magnetism through the field could only draw energy up on energy, that is, on an energised sublimate, and then only if the Stator constitutes a physical link between the magnetic potential difference occasioned by magnetism bound (as in the earth's crust) and in the free state as ether or the surrounding earth's atmosphere—thus operating the Primary Cycle.

But this suction, followed by the reverse, this "energy-breathing" or transpiration occasioned by mobility (as we saw in the case of the sun) does not happen simply because it does.

It is ordered, disciplined, and in fact occasioned by entropy.

In that instant when the concentration of magnetism is brought to the glowing state the energy spiral or entropy spiral starts functioning up and down the Stator windings, and, of course, always in one sense and with a high frequency which Schappeller declares is probably of the order of 10^6 cycles per sec.

This entropy spiral is always present in that instant when mobility obtains due to a glowing core functioning in a fundamental PD—and here we have produced these essential conditions artificially through apparatus, the classic example previously given being the sun or any cosmic variant.

It may be said that frequencies in the radio technique of to-day are far higher, but the work performed in one cycle is very much less. In the Primary Technique the concentrated stressfield is drawn in, catalysed, and forced out in one cycle as a stressfield.

This stressfield, or radiating magnetic stressfield, is available as an attractive or repulsive force for the pro-

duction of mechanical power if a complementary unit of the Stator, that is, a suitably designed Rotor or mechanical appliance (to be driven) itself contains a like substance, upon which magnetism produced in this atomic state, or energy form, can react—the whole, that is the two separate and complementary units, viz. Stator and Rotor, constituting a single Prime Mover, as has already been explained.

The Force exerted on the Stator.

Let us now consider what reaction must be supported or sustained by the Stator where mechanical power is being produced in its complementary unit, the Rotor.

The figure for directional pull, according to our calculations, was 675,000 kilos—the maximum effective power obtainable from a Prime Mover of this size, but which would never be used in practice.

Obviously, as can be seen from the drawing, the Stator would be bolted down and presumably these bolts and the whole Stator casting would have to take the reaction arising from the attraction exerted on the peripheral Rotor magnets of 675,000 kilos. But mysterious as it may sound, the casting and bolts of the Stator would experience no reaction whatever, although the same law holds here, viz. that wherever there is an action there must be an equal and opposite reaction. In this case, however, the action arises not between magnetism bound to two opposing pieces of steel, in which the two pieces of steel will experience the action and reaction, that is, for example, the Stator of an induction motor or the field magnets and yoke of a DC motor which take the torque reaction exerted on the Rotor, or armature, respectively.

Here the action arises from the force of attraction exerted by a free mass of glowing magnetic energy bound to no material whatever; the reaction therefore will be upon the glowing magnetic core as such, which in its turn will be taken by the complementary stressfield. In other words, the reaction of the pull exerted on the Rotor magnets will be taken on the ether concentration arising from the Stator core.

Now consider the reaction on the Rotor. Here, as regards this force, we have similar conditions to those in electric motors of the present day, because the energised sublimate on which the pull is exerted is within or embedded in the steel Rotor casting and the pull will thus be transferred to the casting and thence to the shaft to be driven, and of course will be proportional to the speed and load.

It is obvious that in every case the Stator would be firmly bolted down for stability, *but not in order to take the reaction*. The important engineering consideration here is that the casting would not have to be designed to take this stress.

Fatigue of Metal.

The steel casting of the Stator would, however, experience *fatigue* with time, due to the primary flux, and, allowing a suitable factor of safety, warship engines, for example, might be renewed, say, every eight to ten years—not a serious consideration, since engines or propelling machinery would then consist merely of Stators and Rotors, and the Rotors would not experience anything like the same fatigue.

Furthermore, with the introduction of the Primary Force new forms of instruments would be available for every kind of measurement, including this form of “fatigue of metal.”

Temperature of the Stator.

At first sight it might be thought that the production of an “artificial sun” or glowing magnetism core would involve with it the inevitable production of enormous temperatures, and although this has already been dealt with a few words here in the Technique may not be out of place.

Temperature is a word which we are accustomed to use when we wish to express the intensity of heat, whereas a calorie is a unit expressing quantity of heat, rather perhaps the equivalent in the electrotechnique of volts and amps. But heat expressing both the above measurements is a phenomenon which is associated with air. There is no air in the Stator. If the stem of a thermo-electric pyrometer

were allowed to project into the Sphere cavity, the terrific compression and densification brought about when the Stator was switched on would cause it to disintegrate and disappear; no material of any kind could exist, as such, in a glowing core. So the light-material produced in the Stator (as in the sun) is the product, not of temperature, but of compression through densification.

This glowing core is the densest material which can exist, for two definite reasons:—

- (a) because it is all energy-material and there are therefore no interstices;
- (b) because this primary magnetic material is not merely under exterior compression but is itself the cause of this compression, since every particle of this energy exerts attraction on every other particle and towards a common centre.

In compressing or exerting compression upon itself it is “doing work” only upon itself; there is neither air nor a material (gaseous, liquid, or solid) within the core which could absorb, transmit, reflect or convert this energy into heat.

But the periphery of the core contacts with the special inner lining—a suitable ceramic—of the Stator Sphere, and this peripheral or surface energy will be converted into heat, but on a relatively very moderate scale. Schappeller gives this figure at between 50°–300° C., according to the density required, whereas the periphery of the steel Sphere casing would be much less than this. (See Chapter XXIV, p. 172, para. 2.)

The Arrangement of the Plant for Power Production.

Let us first consider the problem as applied to marine propulsion. Given a single propeller shaft to transmit, say, 8000 ship HP, we should not use one Sphere but perhaps eight, distributed on each side of the shaft, or any convenient number to give a rational compromise between a good characteristic curve and a well-distributed torque on the shaft, the propeller shaft being provided with an equal number of Rotors.

The Universal Transmission of Electromagnetic Power.

This title expresses the dream or final goal of the great physicist, Nicola Tesla (about 1905). In his British Patent No. 8200, he claims to have devised apparatus capable of generating "electrical disturbances" not only approximating to, but even surpassing those of lightning; and he further claims to have reproduced by the aid of such apparatus the phenomenon of "stationary waves" on the earth, or World-waves. By means of such waves he professed to transmit electrical power without the employment of cables.

This dream is now within the reach of Science through the new Primary Technique.

Let us compare the principles of Nicola Tesla and the present radio-technique with that of the work of Karl Schappeller.

The whole of modern radio-technique depends on making a disturbance in the ether through the generation of electrical resonance.

During a thunderstorm Tesla noted that the earth appeared to behave, despite its vast extent, like a conductor of limited dimensions.

He suggested that the wholesale distribution of electrical energy might be possible by means of stationary waves on the earth's surface, using the entire world as a conductor.

So whilst Tesla regarded the earth merely as a conductor, Schappeller discovered that it was the obvious source and storehouse of all available energy, in addition to being a conductor.

Tesla's discovery was of a secondary nature and led him to produce and transmit power by causing a disturbance in the ether through wave propagation by resonance, in which the earth functioned merely as a conductor.

Nearly forty years have elapsed but it is still not feasible to transmit power, as such, on the Tesla system, although the radio-technique has been developed with great success.

Schappeller has always regarded the "causing of a dis-

turbance in the Ether" for the purpose of transmitting power on a large scale as neither feasible nor desirable, and even for small powers, such as are used in the radio-technique, he regarded it as an "invert method."

The Cosmos itself functions, as we have seen, by stress-field on stressfield or vacuum on vacuum.

The secret for the transmission of power on a large scale over considerable distances lies in the rhythmical stimulation of the Ether membrane, of like kind, rather than a disturbance produced by an entirely artificial propagation of what, at present, is termed "wave formation."

The production of a spark is a disruption, whereas the formation of a sun or other variant is not, because the latter is the orderly or disciplined formation of a sublimate out of one of the ether components itself, through polarisation—Nature's universal method.

Again, resonance is a disturbance; a power or bio-magnetic stressfield is not. On the contrary, it is a stimulation which can be utilised through the New Technique for power transmission, telegraphy, telephony, television, production of light and heat, sublimation in place of transmutation of metals, and in the curative applications already cited—and all these in a manner far in advance of that made possible by the highest and latest developments of the techniques based on the Secondary Physics.

Schappeller, in principle, cannot be wrong in this because it is the method by which Nature herself operates in the Cosmos, and the only method available to her.

So magnetism is radiated which, from the physiological point of view, is not merely harmless but actually beneficial and stimulating to desirable forms of life (a subject dealt with in the Medical Section).

The transmission of great power is accomplished by the installation of Power Centrals, that is, Stators of larger dimensions specially designed for transmission of energy to the thousands of power or telephone (new form) Stators throughout a given district—the equivalent of the present transformers or boosters, which will in fact constitute the "new grid." But this dynamic or "energy grid" is free,

mobile, unbound to material or wires, and in its turn is supplied from a Central Station of powerful Stators.

This is the ultimate application of the Primary Technique as a whole; in the earlier stages, the present generating stations and grid could be utilised, substituting for turbo- or hydro-electric Prime Movers the new Stators and Rotors, the Prime Mover sets of the New Technique.

The distributing Central Spheres of "Centrals" or mobile grid boosters, Schappeller declares, will have an effective range of up to 10 kilometres.

It will probably by now be obvious that since this is "biomagnetism" there will also be technical and other applications of the Primary Force of a fundamental character, the nature of which cannot yet be either conceived or visualised.

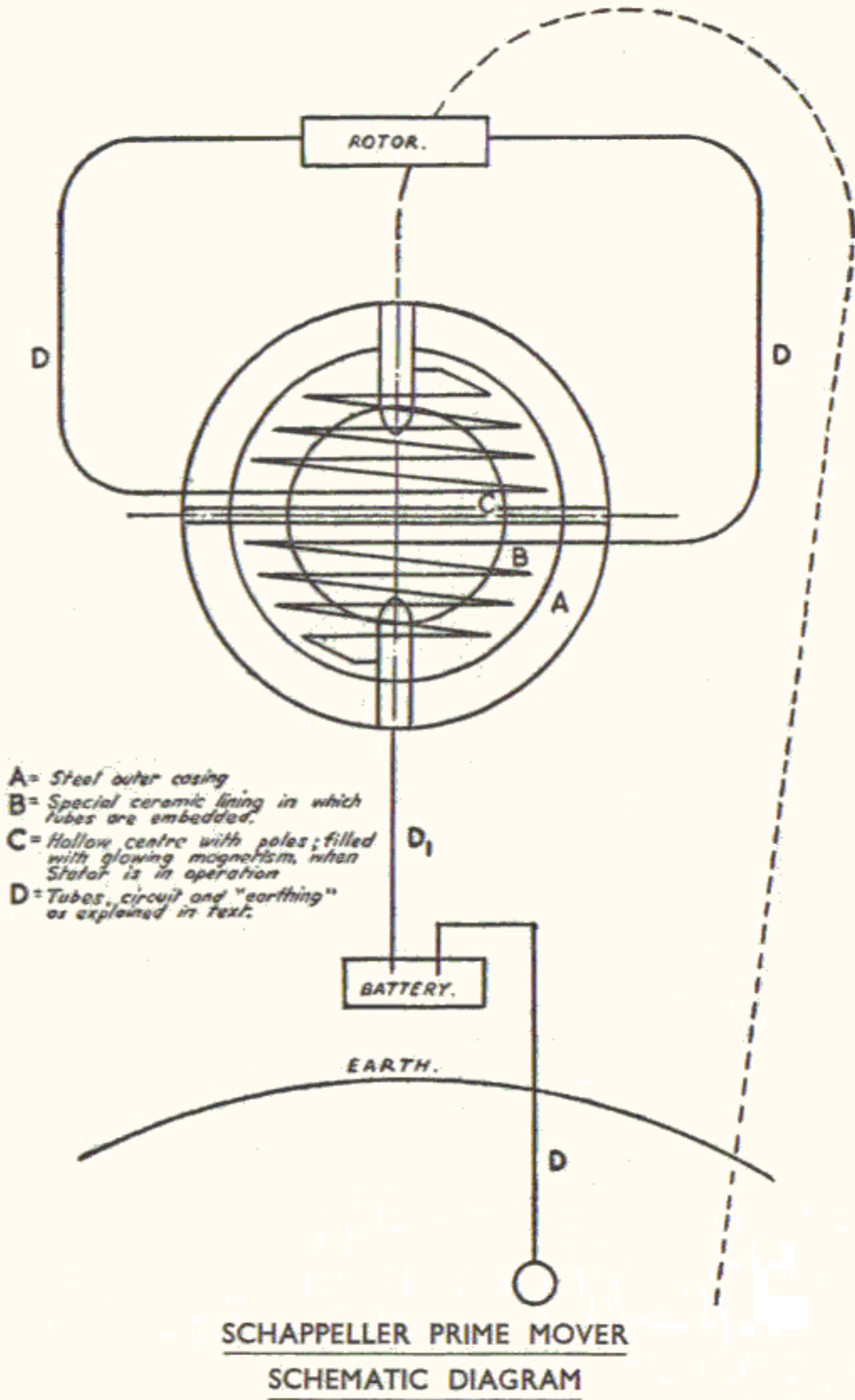

FIG. 17

SCHAPPELLER STATOR

FOR

NEW PRIME MOVER

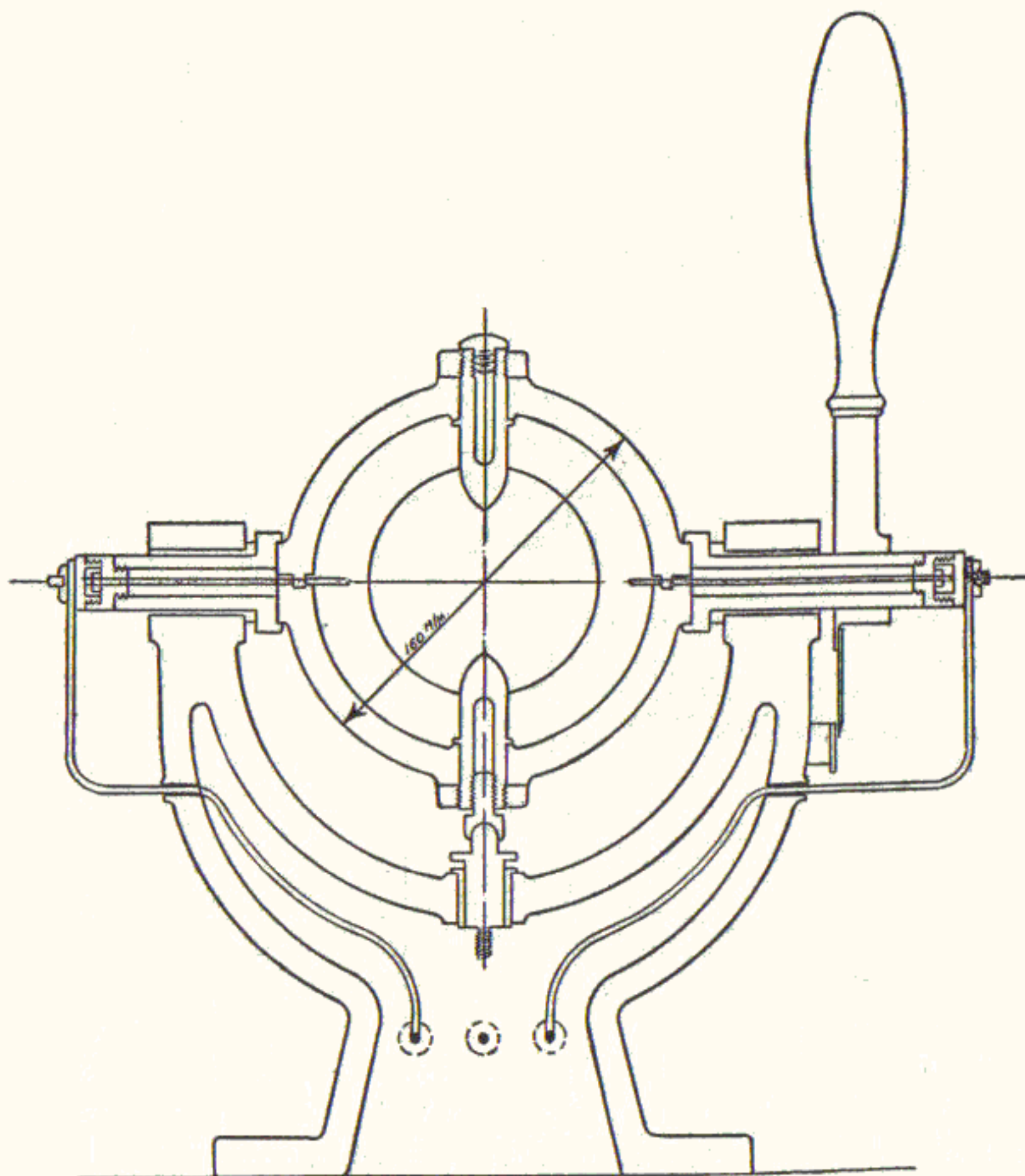
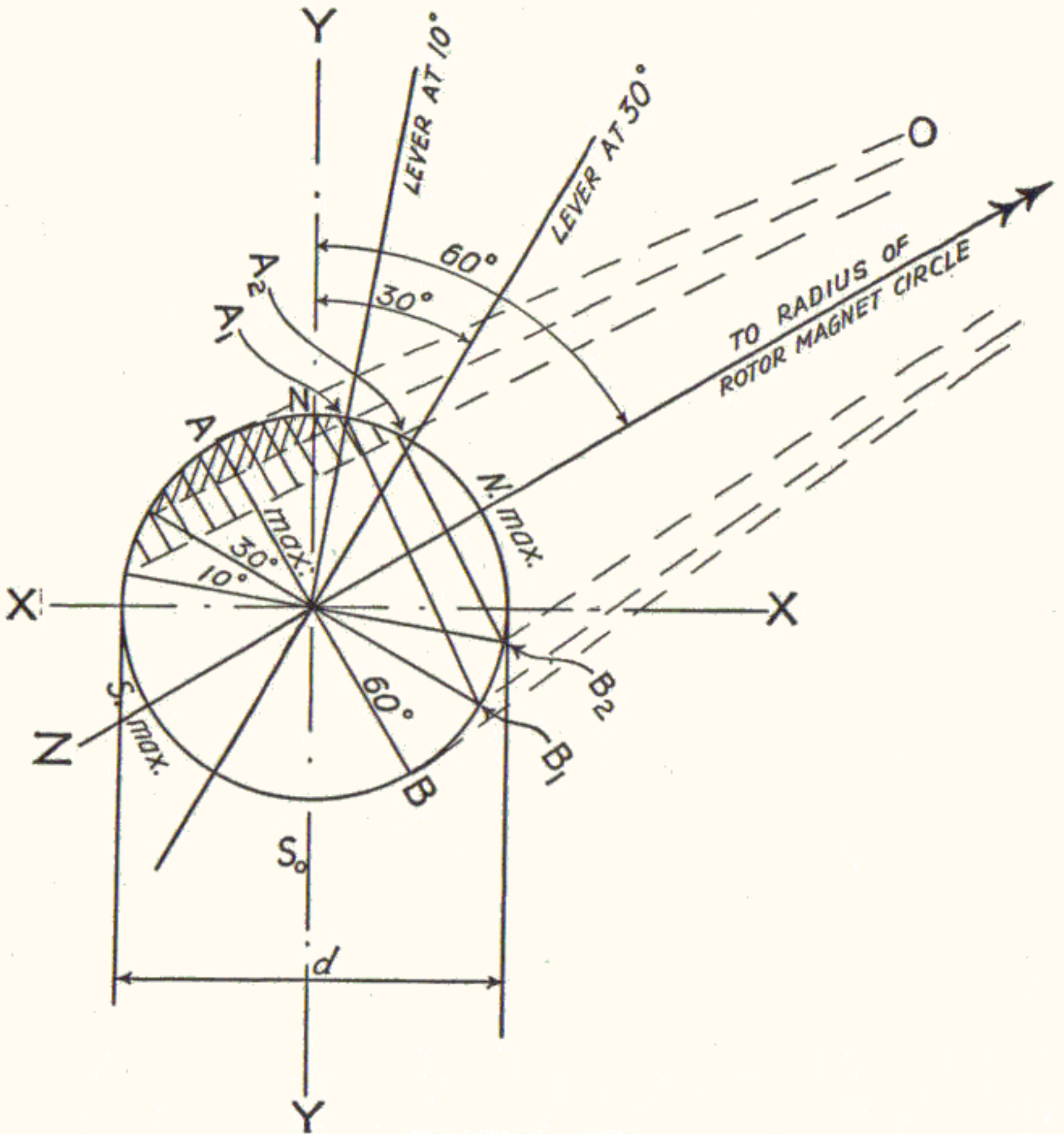

FIG. 18

FORCE EXERTED BY STATOR



FORCE DIAGRAM

FIG. 19

PART III

THE MEDICAL SECTION WITH A SUPPLEMENT

THE MEDICAL SECTION WITH A SUPPLEMENT

The author has made this Section as self-contained as possible because in the case of many medical men it may not be feasible for them to read and grasp the whole of the Primary Physics, but this Section cannot be completely comprehensive without at least reading through the earlier Chapters. Biologists will have done this.

Before we attempt to show the application of the Primary Physics to various forms of curative treatment, it is necessary to make a brief survey of the trend of modern medical researches.

The author ventures to suggest that the pioneer spirits which exist in this great profession, as well as in all the others, are endeavouring more and more to bring physics and chemistry to their aid, and some even go one step further and seek to solve the enigma of man through the premises in astrophysics.

Unfortunately, at least one of the greatest astrophysicists and astronomers declares that the problem of the origin of life must be left to the biologist; and at least one of the most eminent biologists can see in Nature nothing but dead worlds which owe their existence to coincidence and haphazardry.

But, thanks to the amazing work of biologists, we ordinary people are privileged, in instructional films and illustrated lectures, actually to see this wonderful "coincidence and haphazardry" weaving and transforming the different multifarious forms of life, from which we observe that every one of these myriads of organisms, from the unicellular to the human being, is not merely conscious but persistently purposeful throughout its life—whether this be long or short. Many of them are structurally extremely complex, although of such low development that we human beings cannot perhaps perceive a serious purpose in their insignificant and apparently pointless existence. They are,

nevertheless, one and all imbued with the universal law of self-preservation. Through exercising their will they develop an innumerable variety of protections against the particular foe they have to fear, often coupled with an amazing sagacity and cunning, even in the lowest and most primitive forms of life.

An elementary student of that complex subject, palæontology, will very quickly be cognisant of the ordered discipline and definiteness with which this universal coincidence and haphazardry manifests itself in Nature.

Such biologists, however, would declare that this, wonderful as it is, is just "evolution," and that once "it started," development took place and continued. Once what started? As we have seen, in the Primary Physics, life did not start, only organic life. All scientists must and do now acknowledge a living force, and this never "started," but it started organic life when the right conditions existed for its evolution, perpetuation and development.

We are, however, only concerned here with the human cycle as it is to-day, the perpetuation of which depends on its bipolarity or what we term "sex."

It will be understood that it is not the author's business to champion any existing theories, but it is nevertheless his business to discuss the more important ones, and above all to give the Primary Physics explanation, where possible, before proceeding to the application of the Primary Physics itself.

Mr. J. E. R. McDonagh, F.R.C.S., in his *Nature of Disease Journal*, expounds his theory, which is of interest in this connection and which is given here in brief.

He says the word "sex" probably meant originally "division," from the word *secare*, to divide. The successive division of cells, at right angles to each other, presents the first picture to be conjured up in the mind whenever the problem of sex is discussed. It is, however, necessary first to enquire into the cause of the "division" and the factors leading up to it. Here McDonagh calls astrophysics, as it stands at present, to his aid. He is of the opinion that there is no evidence that division has occurred in the Universe, outside the solar system, despite the fact that all celestial

bodies have been formed as a result of the condensation of what may be termed "primary activity."

What he terms "primary activity" is, as we now know, simply the Primary Force, the biomagnetic force, and the first division or polarity, a bipolarity, occurs when the Ether separates out into its two constituent components or complementary parts. This fundamental determination of the bipolar in Nature is the first pregnancy which established for ever the propagation of the species first in the "energy" form and then clothed in the organic forms; it gave the first impulse to every cycle in the vegetable and animal kingdoms.

McDonagh continues by pointing out that condensation is the fundamental action of Nature and that it is responsible for the crystalloid state, the colloid state, life, disease and death.

Here again we know that condensation could only exist through the formation of vapour and that this vapour or moisture was first formed by the overspilling of the hydrogen and oxygen—the two complementary and bipolar energies functioning as vacuum force—after separation of the Ether into its bipolar constituent parts.

Following the theories of the present day, he explains that the formation of the solar system, *so far as is known*, is the first evidence of division; and as its formation is "purely fortuitous, the result of an accident, the production of life and all that leads up to it and has followed it, is strictly speaking unnatural."

It is somewhat difficult to see why the formation of a solar system is considered to be unnatural, although little attempt is made to explain what natural or unnatural process formed the sun, from which we are told all the other variants originated—a fact which the term "solar system" implies. That which is utterly universal and basic throughout Nature, the cycle of life and death, cannot be unnatural.

Apparently, the picture which Science would present to us is that a dead world is born from which life springs, and thus that death is natural but life is an interloper, a curious confusion of thought, a kind of mental astigmatism. The

explanation of the origin of cosmic bodies and life has been given in some detail in the early chapters of this book.

Once the earth, McDonagh proceeds, "became separated from the sun," environmental stimuli were generated, which had varying effects upon the results of the ever-continuously progressing condensation. He says that it is inferred, in the absence of evidence to the contrary, that neither these nor other environmental stimuli exist elsewhere in the Universe. He considers, therefore, that the main feature of the activity of the stimuli is unevenness of action because the result has been the establishment of a disequilibrium between the various products formed by condensation. It was due to this disequilibrium between inorganic salts, particularly when dried and in concentrated solution, that the colloid state originated. The extension of the condensation responsible for the change from the crystalloid state to the colloid state led to the formation of vesicles by which colloids can spread.

This vesicular formation, to which Leduc first drew attention when he dropped a fragment of fused calcium chloride into a saturated solution of potassium carbonate or tri-basic potassium phosphate, marks the dawn of sex.

Further condensation of colloid bodies generated life, which can be studied at its inception in the non-nucleated algæ; such environmental stimuli as light, heat, moisture, etc., upon protoplasm, which is colloid material in an aqueous medium, cause an unequal distribution of water and all it holds in solution. The initial action is one of dehydration of a certain cell area of the cell which results in hydration of another area. The dehydration being an unnatural action ceases, whereas the hydration, being natural, continues until not only the disequilibrium established within the cell itself, but also that existing previously between the cell and its exterior no longer exists. The time comes when the most hydrated or condensed area divides. The division may be into two equal halves or it may be one of "budding." But the process, whatever may be its exact nature, is one to which McDonagh refers as the cyclical change of dehydration.

Sex.

Sex, he explains, is determined by the chemico-physical state prevailing at the time of copulation, affecting not only the gametes but also their generators. Indeed, the chemico-physical state prevailing in the latter is more important than that occurring in the former.

Should hydration prevail the sex of the child will be female, if dehydration male.

In the case of woman and man the sex is considered to be determined and rendered irreversible the moment the spermatozoa enter the ovum. If the result of the conjugation is hydration, the sex of the child-to-be is female, whereas if there is dehydration the sex is male.

He explains what he means by hydration as follows.

Protein particles, he says, are what are called "emulsoid particles," *i.e.* both contain and are contained in water. Moreover, the water which surrounds them contains in true solution every adsorbed constituent of which the particles are made up and even some protein itself.

The adsorbed constituents in true solution are in the form of ions and between the ionic and the colloid state, which is sufficiently colloid to allow the word "particle."

Now water is the medium common to the two phases of the plasma (the colloid phase, dispersed phase or particle, and the liquid phase or dispersion medium).

The protein particles may lose water, in which case the adsorbed constituents break away from the protein nucleus to become more and more ionic until they reach the stage of true solution—this is what he terms "dehydration."

Again, the protein particles may take up water, in which case the particles become richer in constituents because they acquire the simple colloids and ions which the water held. The adsorbed constituents from colloid complexes, with the protein nucleus and the combination, become the more complex the greater the quantity of water taken up; this is what he terms "hydration."

When dehydrated protein particles are increased in number they are smaller in size than normal particles and

their Brownian movements are diminished because of the electricity they have lost.

The sluggish Brownian movements so characteristic of protein particles undergoing gelation are responsible for venous thrombosis.

Protein particles are never acid; they are more or less negatively charged.

There is also the more or less universally accepted chromosome theory, referred to later, but it will be observed that both theories deal only with the mechanistry of propagation and sex determination; McDonagh's carries him, in addition, further forward into the analysis of life, disorder, disease and death. But both theories really start with life as having its origin only in the secondary states of matter. This, in the Primary Physics, is designated only as organic life; origin-life which made and makes organic life possible (when the right chemico-physical conditions are present) exists, of course, first in the primary or energy state, which in its turn owes its very existence and origin to the birth of biomagnetic bipolar interchange, the equivalent of sex as a cosmic entity—that is, as a sun or other variant.

The author is aware that he has said this often, but Nature says it oftener.

The sun is a complete atom, or, in medical language, it may perhaps be regarded as a cell.

Merely for purposes of analogy, we may call the nucleus (hydrogen core) the protoplasm, and its complementary oxygen stressfield the cytoplasm, and the chromosome outfit the interaction between these two due to the functioning of the entropic spiral, but this is as far as the analogy goes.

In the chromosome theory for organic life the cell divides and "grows a body," whereas in the sun it is exactly the opposite process. Here the equivalent of the protoplasm and cytoplasm (core and complementary stressfield) combine to form the conditions for the new body, the crust of an earth, where the essential to all life and material is born—moisture—and where the first hydration and dehydration process begins, and functions so long as the earth exists as such.

Hydration here is the symbol of life, and dehydration (or compacting) the symbol of death. It should, however, be clearly understood that such a simile has its limitations because the principles involved become modified in the secondary states. Why? Because here the operating forces are no longer free, but function as cohesive or adhesive forces and are subject to other restrictions.

The whole of man's history is in his skeleton. It is not possible to examine this yet with present instruments, but it will be when the Primary Force is established.

The whole complex organism of modern man's multicellular and spiritual development arises from the weaving of a body on to the energy-entity frame present in the mother. (For explanation of energy-entity frame, and energy-entities and their origin, see Part I, XV, p. 106, para. 1, and Appendix (2) and (4).) This takes place as a form of primary deposition. This deposition or growth attributed to the cells follows exactly the ordered demands which the conscious energy-entity frame makes on the subconscious brain of the mother, and by which means the frame draws all that is needful in biomagnetic energy-material, but only as and when demanded by the conscious time factor. The biomagnetic energy-entity frame is not a child, it is the complete mature being-to-be, but only in the energy form.

The birth of a child is an emphatic illustration that everything functions according to law and plan.

There is no such thing as the "rough laying out of the body"; the body, or in this case the child-to-be, is there in every detail *but in the energy form*—indeed, more than this, the mature and adult body, male or female, is complete in every detail, as energy, and the organic body is woven on to this by biomagnetic deposition. (Appendix (9).)

However, it loses its mature consciousness after the body is built, as its consciousness is now bound and restricted to the functioning of an organic brain, and the conscious and spiritual actions are then restricted and subjected to the influences, needs and limitations of a material body. Both must grow synchronously to promote normal development.

The energy-entity conscious frame exists, of course, in all seeds, that is, in the seed is the complete plant or tree (with its branches) but in energy form only.

The conscious force of the entity frame is "thought force," produced as it is in the adult human by compressions and known in the Primary Physics as "*sinnergie*" (sense-energy); that this does exist is clearly demonstrated by a statement the author believes is due to J. Huxley and Wells.

"Living things evolve. They produce mutations at random, their germ plasm gropes about in the dark and makes experiments, trying now this innovation, now that. And the formative agent, which acts upon these chance mutations and builds out of them the progressive changes of evolution, is natural selection—undesirable variations are sifted out and thrown aside, successful ones get through and continue in the germ plasm of the race."

What an overwhelming proof of the existence and functioning of the biomagnetic force in budding organic life, or functioning of conscious or "thought force" !

Natural selection is obviously not haphazardry, but proof of the higher form of consciousness, and bespeaks "qualitative sense-energy" and individual entity, what colloquially is termed individuality.

Referring to the remarks of Huxley and Wells, all mechanistry fails at times and the chromosome machinery is no exception.

No process based on natural selection can possibly be "merely mechanical and regardless of any ideal harmony."

It is the observer who can see only the mechanistry; the occasional miscarriage of chromosome machinery is due therefore to the very opposite cause, the lack, at times, of co-ordination between the conscious agens.

The sex condition of the body can of course be altered if the relevant mechanisms, glands, etc., are skilfully and biologically altered—grafting is really a biological operation.

The fact that bombarding the *Drosophila* with X-rays produced mutations, but only in the offspring, is not surprising. It merely means that the subject exposed was stable and insensitive itself to immediate change owing to

maturity, but the absorbed radiation was still sufficiently powerful to affect the generative processes and produce mutations of colour and organic parts in the offspring.

X-ray radiation is disintegrated electric current, which is H and O energy, devitalised, but having the biomagnetic characteristics within it. The radiation of this (in special form—X-ray) on to the biomagnetic energy of an organism produces certain mutations when all the right conditions obtain.

Mendel's theory is obviously an established law for stable mutations in certain inter-breeding.

Colour is not just "wave-length"—this is only a method of measuring it; it is a characteristic expression of the conscious sense-energy in physical form. (Colour and the spectrum, however, are dealt with later.)

The immense complexity of the secondary states of matter cannot be entirely dissected by mental surgery alone. Even in chemistry, not merely in gaseous functioning, but in processes promoting complex chemical reactions by direct energy catalysis, we have indisputable evidence of this. The green colouring matter of plants is attributed to chlorophyll, but it is also essential to the life of the plant because this particular colour is a characteristic expression in energy form of a plant's organic vitality derived, of course, from the biomagnetic force. A glowing magnetic core, sun or other variant, has all the colours in it, and the compression of all the colours gives white light; this is why snow is white, because snow is water, and water is hydrogen and oxygen energy, which is the original composition of the sun.

Chlorophyll acts here as a catalyst in the photosynthesis of carbohydrates from carbon dioxide and water.

It is stated that "All we know about the genes, materially, is that they are structural and chemical, the rest is based on their observed effects."

All chemical action, no matter in what form, is the result of energy combination or the reverse, resulting in sublimation; in organic life of any form it is promoted by the conscious biomagnetic force of which the genes are the servants.

In so-called organic and inorganic chemistry (in this latter the biomagnetic force is present but latent), new products are formed to chemical formulæ. But in biochemistry proper, we see at once that other factors play their part due to the conscious urge and guidance of this biomagnetic energy—*e.g.* genes produce their characteristic actions by influencing the *speeds* of processes occurring in the body. Thus, for instance, in biochemistry we are told that the rate at which dark pigment is formed and reaches its final condition in the eye colour is slowed down in true blue eyes by the influence of a particular gene, this gene being controlled here again by the conscious energy.

Again, Huxley and Wells say "It is a disturbing idea that life has evolved and is still evolving under the spur of those strange rays, shot casually into our world, from unknown corners of the Universe".

Surely this is "Science with the blinkers on." It is essential that the various branches of Science, *i.e.* astrophysics with its technique, astronomy; physics; chemistry; biology; physiology; palæontology; etc., etc., should constitute separate studies as no one human brain could assimilate them all, except by becoming a jack-of-all-trades and master of none.

But in pursuing one or more of these established branches of study and possibly their application through their corresponding techniques, one basic, guiding and controlling factor should always be borne in mind, *that Nature is one unity*, and that the subdivision of our studies is merely a necessity because of the limitations of any one human brain; *in Nature herself no such subdivisions exist*; the biomagnetic force or energy is thus universal in its functioning, although in advanced secondary conditions this force is latent. Life itself was not evolved but created—rays, strange or otherwise, could not produce life in the energy form. The biomagnetic energy-entity is a creation, not a product of evolution; organic life was not evolved by such rays but in the manner which has been previously explained in this book. Furthermore, cosmic rays are not strange; they are the end-product of

cosmic cores resulting from the disintegration of cosmic variants. They are also, of course, of biomagnetic origin; their composition and origin has been detailed in previous chapters.

The whole of the Universe functions on the conscious plan and purpose of its Creator and is one Unity, but free will also exists universally, and thus miscarriage of plan often delays or diverts the universal purpose and plan, giving an impression of haphazardry, which, however, is not really delay or diversion at all, but exists to promote the effort, sacrifice and courage which all forms of organic life must display in order to attain self-preservation and reproduction. It is a universal law that nothing useful shall be accomplished without effort expressed through "thought impulse."

In the higher forms of life, and particularly in the human being, such effort and sacrifice (both of which are conscious qualities of the biomagnetic force) are the cause of spiritual growth, or, where wrongly directed, spiritual degradation.

Man is thus a spirito-conscious-chemico-physical creature, the organic product of a conscious-physical world, nurtured and nourished by the elements or environmental stimuli, fire, water, earth, and air, and by saturation of internal (from the earth's core) and external radiation (sun and cosmic rays). If any one of these failed, man would not exist with all the characteristics with which he is now endowed. How he uses them is largely his own responsibility.

What the Primary Physics teaches us is that an ABC system and permutations for which the biologists are searching simply do not exist as such because of the free will granted to organic life, and even here Mendel's theory shows a materialistic system which functions within certain limits, whereas in the devitalised world of so-called "elements" we have not Mendel's biological table but Mendeleeff's periodical tables. Thus, in the devitalised condition an ABC system with permutations satisfies the materialistic functioning, but we must neither look for nor demand a complete solution to biological problems on these lines.

The elements (so-called, as we now know that they are not basic as such) have no free will and have the conscious energy, but only latent as cohesive force, within them.

In the second application of Mendel's theory we see how the crossing of two widely different strains affects the breeding of plants and animals, which is, of course, merely a further basic proof of the fundamental law in the Primary Physics, viz. that Nature produces and transforms energy only by the crossing of stressfields—stressfield on stressfield, or vacuum on vacuum—and in the material state it is the same but instead of the actual stressfields in the energy form we have sublimates out of organic stressfields crossing, and thus reproducing or transforming the species in question and forming other varieties. The permutations arising from this law, used in wheat and cane sugar, for example, produce other varieties. Again, the *vitalistic theory* of Henri Bergson ascribes evolution “to some directing, purposeful force residing in life but not in matter, which is not alive.”

This directing, *purposeful* force is the biomagnetic force and it should be noted that it is termed “purposeful,” which is merely another word for consciousness and free will, but it does not merely reside in life, it obviously built life as it is the life force, but only manifests itself to Man in material form through an organic body—hence the fallacy. In matter it does reside but as latent, conscious cohesive force; it could be vitalised but the material would then disintegrate. The cohesive force of material is not alive, but functions subjectively to retain its space-form when subjected to stress of any kind.

The complete history of any given piece of material could be obtained by the vitalising of the cohesive force by special apparatus and instruments, but only after the Primary Force is available.

And so “evolution” is the conscious functioning of the Creator through the medium of the biomagnetic force and the permutations of all other processes arising out of this spiritual (or conscious) chemical and physical force.

Darwin says the “formative agent” is “natural

selection," but this is merely begging the question. What is natural selection? The functioning of qualitative energy with free will, but through thought-impulse. The thought force functions the biomagnetic receptacle we term the brain through energy compression, which is accompanied by potentials of periodic varying character (*Proc. Roy. Soc. Med.* Vol. March, 1937—Walter), but this biophysical aspect of the brain is dealt with later.

Then there is also the theory of dualism, which asks: what is the correlation between mind and body, organic and inorganic? What is alive and what is dead?

There is (speaking absolutely scientifically, that is, basically, and not merely colloquially or for purposes of technique such as in chemistry) no such thing as inorganic unless this word is restricted to mean "latent organic" or devitalised material, as has been previously explained.

Alive or life is when the biomagnetic force is dynamic, dead is when it is "frozen" or static as cohesive force—*all material is of organic origin.*

The word "mind" is too colloquial or philosophical; it can have no place in scientific phraseology unless we define and analyse it to mean something specific.

The mind is obviously not an organ, the brain is an organ. We can perform a surgical operation on the brain, but the mind can only be affected by psycho-analysis or suggestion. Naturally, if there is any mechanical defect in the functioning of the body or glandular system, this must have its reaction on the mind.

The mind is thus the spiritual quality of the brain and the brain is the instrument. In the more precise language of the Primary Physics it is the ego, *i.e.* the seat of the energy entity, or, to be quite precise, it is the spiritual functioning of the energy entity. Herein resides the faculty of "natural selection" and indeed the general faculty of selectiveness. Thus, the mind is the functioning of an organ (the brain), not itself an organ.

Now we have already seen that life does not begin and end with the body; only organic life has this limitation.

First the life-force (or energy), then life-entity, organic

life, and return to life-entity, but always life-force (biomagnetism), as this is the origin-life force at the core of each cosmic unit from which organic life is ultimately born, and it is the creative force in Nature.

The body is woven by biomagnetic deposition on to the energy-entity frame (or ego), a physical process, but entirely controlled and directed by sub-conscious (and conscious) mind-functioning.

The whole body, not only the brain, is not therefore merely "inter-related," but physico-spiritually interwoven—the dualism is not therefore dualism but one complete interwoven unity.

The Ether is a sublimate out of the Creator's vacuum force. He is vacuum force itself, otherwise vacuum force which finds its physical form in glowing core and complementary stressfield could not exist. The Ether is thus conscious or spirito-physical, and since it pervades everything, the Creator functions or is present everywhere—omnipresent—but His energy is latent in material.

This is why we should treat material with respect—it wishes to serve us. We do so at present, but only because it is scarce, yet its scarcity has shown its value and significance; even waste material, formerly considered to be refuse, is now necessary to preserve our very existence, our freedom and culture as a people.

When the New Power is produced and is available through the techniques, it will have much, as we shall see shortly, to offer the medical profession, but what will it have objectively to offer the biologists? It should place at their disposal new biomagnetic instruments for the real biophysical examination of the human being functioning in health, disorder, and the final stage of disorder—disease.

We have at present the microscope with glass lenses, which gives a very high magnification value, but it is an optical instrument dependent on and restricted by the limitations of vision—through lenses; nevertheless, the modern microscope has reached a very high stage of development. The ultra-microscope can detect particles of even less than 6×10^{-6} mm. dia. magnitude, which approach very

closely to molecular dimensions of complicated compounds; this instrument is capable of resolving over 100,000 lines per inch.

But there is already a further development which represents a departure from the orthodox optical instrument, the electron microscope, consisting of a suitably designed instrument wherein an electric current is made to flow through a filament emitting a stream of electrons. Just below the filament there is a difference of voltage which accelerates their downward speed. Further along are the magnetic fields which bend the stream to a focus. A fluorescent screen at the focal point allows the human eye to see in great detail the shadow cast by the specimen in the path of the electron beams.

The wave-length of electron radiation varies according to the speed of the electronic radiation and that depends on the voltage spurring it on.

The electron microscopes in use have a range of 10,000–90,000 volts, giving a wave-length of 50 AU. But a million volts moves electrons at more than 175,000 miles per sec., giving wave-lengths of about 10^{-2} AU.

Atoms are some 2 AU apart in a molecule of C and H atoms. It is not considered impossible to build up millions of volts, and thus shortly molecules may be photographed.

With a magnification of 8,000 diameters a resolution of 0.5μ has been obtained which surpasses the optical microscope—100,000 lines per inch being the equivalent of $.62 \mu$.

As there are no glass lenses very hot specimens may be examined.

This was accomplished with an instrument of $6\frac{1}{2}$ inches in height. Large electron-microscopes of great height far surpass this, giving a magnification of up to 100,000 diameters.

The resolving power cannot be less than half the wave-length of illumination and when the difficulty is solved of focusing gamma rays or X-rays the power even of this amazing instrument will be vastly increased.

So, in the *optical microscope*, the rays of light are bent or focused with glass lenses.

In the *electron microscope* a stream of electrons is bent or focused by allowing it to pass through a series of magnetic fields.

There is also a *gamma ray microscope* for the measurements of Observables in relativistic quantum mechanics.

Thus radiant energy is being applied more and more for visual examination, although perhaps somewhat indirectly.

The Schappeller microscope will have lenses of compressed energy; this does not, however, mean that they will be lenticular in form. The underlying principle of this new instrument will be based on the application of the Primary Force. In place of glass lenses (cohesive force), electron rays or radiation, we shall have the radiation in the form of a stressfield from glowing magnetism.

A specially designed Stator could produce daylight diffused and as Nature produces it. A further technical development will enable this radiation or stressfield to be used directionally for the purpose of ultra-vision, making energy itself visually observable.

To be able visually to observe energy and its functioning, energy "lenses," using an old technical expression for an entirely new form, are necessary. This will be of immense value in all classes of fundamental or basic research and particularly to biologists and medical men. New units of measurement will be evolved, just as they were in the introduction of the electro-technique. We have our heat units for the steam technique; volts, ampères, ohms and watts, and the units of inductance, capacity, etc., for the electro-technique; likewise, in the illumination technique, the lumen, candle-power, foot-candle, brightness unit—all of which units have their common origin in the fundamental units of energy which are interchangeable or convertible.

But with the devitalised forces now employed in Physics "qualitative energy" cannot be brought within the range of the so-called exact Physics, such as conscious qualitative energy, which is therefore vaguely termed vitalistic energy or life-energy; for this there could at present be no units

because the instruments function on secondary forces. Nevertheless, the measurement of this force or energy is of prime importance to the biologist and in medical research, and it will be (however ridiculous it may sound at present) to the astronomer, who would then become an astro-biophysicist and who would at last relate the conscious-physical planetary reactions instead of merely interpreting their gyrations as endless and aimless relative motion. Herein lies the fight between astronomy and astrology, neither of which is at present fully equipped to fulfil its purpose.

A modern aeroplane starts from its base and is swung, directionally, into its course and steered with certainty to and on a far distant destination.

Migrating birds do exactly the same—in fact, they accomplish more with nothing to assist them but their sense-energy and the atmospheric stressfield. They know the exact season and time at which migration is to take place and use their equivalent of the pineal gland in man to find their direction. But instructional films show that, unlike the aeroplane, with its accurate directional instruments, the birds must, after first “taking off,” make several gyrations before swinging into the final direction for their destination. Why? Because they must cross the atmospheric stressfield with their biomagnetic stressfield in order to stimulate their organic sense instruments. Their conscious biomagnetic energy is already impregnated and qualified by and to the sense-energy prevailing at their destination, due to the ground radiation emanations and organic characteristics, and thus their direction is “mapped” just as clearly and precisely as it is for the navigator in the modern giant aeroplane.

But the migrating birds have a further significant and highly developed faculty. So sensitised are their biomagnetic organic stressfields to the functioning of the ether that they have pre-knowledge or cognisance of any impending disaster. It has, in fact, been proven that they will alter their course, or migrate earlier, to avoid some natural devastating catastrophe, such as an earthquake or the like, of which man is in blissful ignorance until it is actually upon him.

The Time Factor.

Einstein shows its importance and that even an ultra-materialistic conception of the physical world is impossible without it. The Einstein Theory of Relativity has upset some of the Newtonian axioms and has apparently carried research towards a physical origin of matter. Yet Newton made one statement which was really the "thought-impulse" of the Primary Physics, but over two centuries had to elapse before another came who was able to develop it. Newton's words were—

"The main business of natural philosophy" (the old name for Physics) "is to argue from phenomena without feigning hypothesis and to deduce Cause from Effects till we come to the very first Cause which is certainly not mechanical."

Modern Science at last admits "energy first, then material," but energy to the scientist is still "merely physical," hence the new and elaborate doctrine from Germany—"wave mechanics"—*Wellenmechanik*. But the physical cannot produce a living world, and a living world cannot be produced except by a living Universe, and a living Universe could not be evolved except from a life-force, and the life-force (shown here in the Primary Physics to be the biomagnetic force) could not, in the words of Newton, have its origin in the mechanical! Hence, wave mechanics can be defined as a system of measurement for certain *physical* manifestations and conversions of energy.

If Huxley declares that "life has evolved and is still evolving under those strange rays" (cosmic rays), then those strange rays must obviously be life-giving conscious energy—biomagnetic force. Gamma radiation or the like could not be the origin of life and therefore certainly not of organic life, which latter is apparently all that Huxley can see at present. And we have seen that organic life has its origin not in, but in the functioning of, the earth's central biomagnetic core.

But man's state of conscious development could only keep pace with his physical or organic growth, and this was

and is regulated and controlled by the time factor existing in the conscious physical Universe determined by the conscious Ether, the origin sublimite of all creation—a factor the physical aspects of which may be conceived mathematically, but the mathematical symbols cannot include the conscious or spiritual and the two are completely blended as one.

The relative sudden or ultra-rapid development of man's conscious or spiritual qualities is due to the time factor. This is the real origin of evolution; time is not a mere mathematical concept having its origin in the relative motion of planets. Basic time is the cosmic measure of progress, of the conscious development of the Universe, with which we on this earth are synchronised; "happening" need not but can only take place when the time factor allows.

The Emotions.

The real spiritual man (whether high or low) is the energy-entity frame, which has its base in the skeleton but suffuses the whole body with its biomagnetic stressfield, giving muscle-sense to the limbs and functioning consciously through the spinal column to the brain (which latter is considered later).

Now what are the emotions and from where do they originate?

The spiritual urge in adult man is from the energy-entity frame—that is, what each individual is, without the organic body. This is the naked personality of the individual, but this becomes considerably modified and distorted by the needs and desires of the organic body and its reactions to its mental and physical environment, *e.g.* air, nourishment, rest, physical conditions of temperature, humidity, etc., and the fight which each individual wages to obtain what he considers his rightful share of these essentials to give him bodily comfort and security and mental recreation.

His mental make-up is the energy-entity frame, but functioning through an organic body mentally and physically sensitive to every kind of environment including energy radiations.

Now, the statement that a man is what his glands make him is all very well, but it is just as incomplete as saying "The motion of a train is its wheels." The motion of a train depends on its wheels, and the emotions of a man may ultimately depend on his gland secretions. But the point is, on what do his gland secretions depend? The origin cause of everything in man is traceable to the thought-force, even hereditary ailments. So a truer statement (hereditary defects or damage to the body exempted) is that "a man is as he thinks." For it is an undeniable fact that the functioning of the glands is greatly influenced, if not actually controlled by, thought-impulse; and the reverse, in which the glands promote thought-impulses, is also possible, except, as stated above, where hereditary defects or damage to the body or brain distort the process of thought.

The emotions originate in the thought-force, but are modified or changed by the biochemico-physical condition of the body and the time-environment factor, both of which are always changing and both of which produce "mood," the one individual being sensitive to one set of conditions and the other more sensitive to another set of conditions, according partly to the astro-type and the particular manner in which each individual exercises and manipulates his thought-force—motive and mood are twin brothers under the skin.

Catalysts, Enzymes, Colloids and Adsorption.

Catalysts.—Catalytic action initiates, accelerates and stimulates chemical action between two or more substances. For example, platinum in spongy condition accelerates the combination of H and O gases by bringing about combustion because in this condition the vacuum cohesive force of the spongy platinum can react on both the gaseous energies, accelerating the process to combustion or combining point, when a new condition of cohesive force takes control and forms the next state—the liquid state, water.

Enzymes are nitrogenous substances produced by and associated with certain living animal and vegetable tissues; they are therefore virtually "organic catalysts" and, being

colloidal, function through their great surface action and through their conscious sense-energy; they also exhibit individuality and character as we should expect from organic catalysts.

Their action is mostly through a secondary state of mobile exchange, known in chemistry as hydrolysis.

Colloids.—The crystalline and colloid form is really largely one of degree. The colloid has the characteristic of the crystalline form in it, because, as was explained earlier in the book, the crystalline structure is actually the “magnetic frame” on which the substance was built. In the finely divided colloid this structure is still present, but in too minute a form to be examined, although X-ray proof of crystallinity in colloids has been afforded in respect of silica gels.

Adsorption is a surface action which takes place when the chemico-physical conditions enable the vacuum force to function on suitable substances in contact, according to the various adsorption processes. The Ether itself has a similar functioning. It is capable of drawing the magnetism out of a piece of steel when the heat stress intensity in the steel enables the Ether to obtain a hold on the magnetism, which takes place at a temperature in the vicinity of 760° C.

Similarly, if we place a seed on the top of an oven or the like, the biomagnetism will finally be sucked out by the vacuum force of the Ether, and the seed, although materially intact, will be quite useless for germination or producing growth.

Drugs.

Every drug, says McDonagh, introduced into the body is an invader, *i.e.* it causes initial dehydration, which is followed as a rule by some degree of hydration. However co-valent a chemical compound may be in behaviour outside the body it exhibits some degree of electro-valent action when it reaches the bloodstream.

The effect of invasion is influenced first and foremost by the state in which the protein particles in the plasma happen to be, and thus by the nature of the preparation.

This, he declares, is the reason why the same drug may have an entirely different action on one occasion from that exhibited on another.

If the compound be one which is being employed as a therapeutic agent it may prove beneficial on one occasion and harmful on another.

Disease, he explains, is the result of protein hydration, and when a drug causes the manifestation to vanish it does so by subjecting the hydrated protein particles to what he calls "dispersion."

As dispersion, however, is the initial stage of dehydration of hydrated protein particles and the first step in the cyclical change, he replaces the word "dispersion" by "superficial form of dehydration," in order to save confusion.

He thus draws the conclusion that a beneficial therapeutic action from drugs is purely fortuitous owing to the ever-changing chemico-physical state of the body. Actually it is even more complex than this. The present indeterminate and largely indeterminable factor is the unceasing fluctuation in the chemico-biophysical condition of the body, which at least in certain cases, if not in all, may be attributed, but in part only, and to a greater or lesser degree, to the rapid activity of the thought-force. It is this that sets a boundary to the skill of *present* diagnosis. The new biophysical instruments available *only* when the Primary Force has been produced and developed for medical use, together with the new apparatus for curative treatment by biomagnetic radiation, will enable the momentary condition of the body not only to be diagnosed with vastly greater accuracy, but to yield rapidly to treatment. They will arrest the progress of the ailment, and last, but by no means least, stabilise healthy and normal metabolism and restrict abnormal asynchronism not only of conditional body fluctuation, but also of the mind.

Speaking generally, McDonagh explains that the first action of any "invader" is dehydration of dynamic resistance. If dehydration is general and severe there occurs a universal increase in particles with feeble Brownian movements, occasioned by a loss of electrons and of particles which have the chemico-physical characteristics of albumin.

Hydration is a sequence of condensation, and should condensation increase one large particle gives rise to several smaller particles, all of which retain certain characteristics of hydration. When the change affects the nucleolus of the cell the cell becomes what is termed "malignant." Indeed, he contends that cancer is merely an altered chemico-physical change occurring in the vital part of a cell whereby many further cells are formed, each generation behaving more as a foreign body or invader than did the first aberrant cell. Herein, he says, lies the explanation as to why cancer is more common in the old than in the young; age is synonymous with progressive dehydration, and wherever there is dehydration there is a varying amount of hydration. He claims, in fact, that hydration occurs usually as the result of dehydration rather than *de novo*.

The Electric Current in the Treatment of Diseases. (Reference Wolf, *Physical Therapy*.)

Electro-Therapy.

It is agreed by the highest authorities in this branch of the medical profession that the electric current itself has no magical or mystical curative powers, and it is therefore used in electro-therapy of all kinds as an instrument or means to an end.

Galvanic Current.

The stimulating effect of this current depends on the number of interruptions—CC has no effect.

If, however, the interruptions are very frequent the physiological effect of such a current is similar to the faradic current.

If the interruptions exceed a rate of 40,000 per sec., no stimulating effect is obtained—it is then called high-frequency current.

The action of the galvanic current depends on the polarity. The effects of the two poles differ from one another.

*Polar Effects of Galvanic Current
(after Cross)*

<i>Negative</i>	<i>Positive</i>
Vasodilation	Vasoconstriction
Liberation hydrogen	Liberation oxygen
Liquefies tissues	Hardens and dries tissues
Soft scar	Hard unyielding scars
More painful	Less painful
Alkaline reaction	Acid reaction
Alkaline caustic	Acid caustic
Increases bleeding	Decreases bleeding

We know that according to the ionic hypotheses all acids are resolvable into *hydrogen ions* and their respective anions, and the characteristic properties of acidity are due to the presence of hydrogen ions. Acids may thus be viewed as "salts" of hydrogen and bases as hydroxyl salts of respective metals.

But hydrogen electro-chemically behaves as a metal, so hydrogen ions represent acidity and hydroxyl ions alkalinity—the physiological reaction being the reverse.

The different polar effects are, of course, due to the electric current being hydrogen and oxygen energy.

Electrical stimulation in physiology has for its sole purpose the production of a hyperæmia in inactive muscles or muscles which cannot be moved. In other words, the current is used to produce a contraction and it is quite unimportant how this is produced, provided that the stimulating force is not harmful.

Iontophoresis.

It is possible to introduce ions by this means into the human body in a very active form. The two important points here are polarity, as we have seen from the Table, and, of course, the selection of a suitable chemical.

Faradic Current. (Such as that from an induction coil.)

The action here again depends really on its stimulating qualities. The faradic current possesses no mysterious powers but depends on the improvement of the blood supply to a muscle under treatment, resulting from contraction.

High-Frequency Current. (Over 40,000 cycles per sec.)

Used for:

- (1) Diathermy.
- (2) Dissection, coagulation, dehydration (surgical diathermy).
- (3) The production of ultra-violet waves.
- (4) Unipolar high-tension applications.

The basic formula here is:

$$N \text{ (frequency)} = 2\pi \frac{1}{\sqrt{LC}}$$

L = self-induction

C = capacity of condenser.

By choosing a condenser and inductance according to the formula, frequencies of 500,000–2,000,000 and more can be attained. *Such condensers have no chemical or stimulating effects* and produce nothing but heat in the tissue through which they pass, according to Joule's law, expressed in the formula:—

$$Q = (\text{heat in gram-cals.}) = k \times r \times t \times i^2$$

(*r* = resis., *t* = time, *i* = intensity, *k* = a constant)

According to Nernst the stimulating effects or physiological

action of diathermy = $\frac{\text{intensity}}{\sqrt{\text{frequency}}}$.

Modern diathermy apparatus supplies a frequency of about 10^6 and therefore produces no chemical action.

Static Electricity.

Likewise with the therapeutic application of static electricity, the chemical action, if any, is negligible, owing to the minute amperage—it is used as an internal massage,

here again brought about simply by producing strong contraction at the place of application.

Diagnosis.

The electric current is also used for electro-diagnosis, for which purpose instruments supplying the following forms of electricity are available:—

- (1) Galvanic currents.
- (2) Faradic currents.
- (3) Condenser discharges.

Heat and Light Therapy.

Obviously rays from any source can only influence those layers to which they can penetrate and in which they are absorbed and can act.

So far the range of rays in therapeutic use and whose action is understood is from 1,800 to 14,000 AU:—

- (1) Bacterial rays.
- (2) Antirachitic rays.
- (3) Erythema-producing rays.
- (4) Pigment-producing rays.
- (5) Heat rays:
 - (a) visible rays,
 - (b) infra-red rays.

There are various artificial sources of radiation, each supplying the wave-length required under conditions suitable to the various forms of treatment.

These may be divided into four groups:—

- (1) Quartz lamps (mercury).
- (2) Carbon arc lamps.
- (3) Incandescent lamps.
- (4) Infra-red ray generators.

Sun baths are also valuable, but it is not known which plays the more important part, the sun or exposure to the air; furthermore, great caution is required in using the direct rays of the sun for therapeutic purposes.

*THE APPLICATION OF THE PRIMARY PHYSICS
FOR CURATIVE PURPOSES, THROUGH THE USE
OF THE PRIMARY FORCE*

This would not be understood unless we first examine, not merely biologically or physiologically but basically, what Man really is in his present state of development. The brief review just given begins, as it should, with the origin of organic man, which undoubtedly is due to what we term sex. But if we assume that McDonagh's explanation of the origin and functioning of sex in the propagation of the human species is correct, even then it only explains, as it were, man's *organic perpetuation, not his origin.*

In the early Chapters the origin of worlds was explained at length and this cannot be recapitulated here, but it can be very briefly summarised in order to show the sequence leading up to life (organic), its propagation or sex functioning, and finally the two conditions to which every organic body is liable:—

first "disorder,"
then "disease."

The fundamental origin of all sex is bipolarity, and bipolarity means the mobile interaction due to the separation of two components formerly (or before separation) constituting a latent homogeneous equalised out condition of the energies, which in the first static condition we term the "elemental" (the Ether).

From the sex standpoint the Ether is therefore aphrodite, splitting up through polar resolution of its components into male and female, hydrogen and oxygen, north and south, plus and minus, or whatever similar notation is favoured. This is, of course, purely a simile. There is no actual sex here because there is no entity. But when the law of bipolar separation and its functioning was established in the Ether, it gave origin and decree for the universal law of sex propagation in the organic world, and the first

organisms were of course the aphroditic cosmic bodies themselves.

The vacuum force (or interpolar exchange between a hydrogen core and its complementary oxygen stressfield) built and builds a crust and the physico-chemical conditions necessary to the production of organic life. The cosmic body in question, in our case, the world, had through its polaric origin the characteristic of sex within it, which is really nothing more nor less than the weaving of organic substance through polar mobile interchange.

The crust of the earth, as we have seen, was formed in this way. If the earth, or an earth, is not perpetually in mobile interchange, it could neither exist as an earth nor even ever have formed the crust. And as it is in mobile interchange it must be a living earth, because mobile interchange is the functioning of the life-force in its origin state and is thus the source—the only source—of organic life in its multifarious forms.

Again, if this force were not conscious, consciousness could not exist in anything on the earth, and we know that all life, even its crudest and most primitive forms, possesses this amazing faculty of consciousness, which is not “supernatural,” but supremely natural—it is, moreover, the utter and irrefutable universal sign of a Creator.

So first we have consciousness and polarity in the energy form, building the secondary states of matter, the gaseous, liquid and solid states. But there is still a missing link—the energy entities or biomagnetic entities in the energy state, that which all life entities are before the weaving of an organic body.

The study of present Physics and chemistry demonstrates in its various branches that literally nothing in Nature exists which is not built upon a definite form or pattern. This is, in fact, not merely confined to so-called living things or organisms, but also to the crudest physical structures, such as the snowflake, whose geometrical patterns are of many designs but always present a specific and definite geometrical figure. This is the biomagnetic interlinking upon which the whole study of crystallography also depends.

The biologist, veterinary surgeon and medical practitioner are concerned with the weaving of an organic body on to this energy-entity frame, the final result of which we term "birth," and afterwards with the functioning of this new organism, whether vegetable or animal, through its organic life-period. Naturally, it existed as an energy-entity before organic birth and does so again after organic death and subsequent re-birth into the pure energy form.

The energy-entity as such is everlasting, whereas the organic entity woven on and to it is of short duration. "Life," said a poet, "is a short space between two eternities."

Keeping from now onwards to the human cycle: the doctor, in treating any unit of this cycle, *i.e.* man, woman, child or unborn child, is concerned not merely with an organically produced body built up of protons, electrons and neutrons, he is also confronted with a spiritually conscious entity attached or attaching itself to an organic body.

The organic body acquires polarity, which is sex division. It functions by sub-division of cells, a process having its limit, which must finally end in organic death.

The spiritually conscious entity is attached or attaches itself to the organic body through the slow process of weaving, a process in which three consciousnesses play their part—the mother, the entity as yet unborn, and the father—and finally at the date of birth there is the influence of the magnetic field or resultant bio-astrophysical setting reacting on the newly-born child at the instant of birth, the child itself being basically a magnetic entity. This last reaction determines definitely and for its entire life (whether male or female) its temperamental characteristics, under the zodiacal signs given the names of Leo, Libra, Sagittarius, Aries, etc.

No individual ever escapes this temperamental impregnation, the hallmark, whether good or bad, of temperament, that is, of characteristic *but definitely not of character*.

It has been asked, why at birth? Why does not the resultant planetary magnetic field affect the child-to-be at the commencement of conception rather than at actual physical birth? Obviously, because the child cannot be magnetically impregnated until that moment in which it

becomes, not a separate entity (it was always that) but a separate organism, and more, an organism functioning separately.

This phenomenon, which can be universally observed and proven, is no mystery, since we ourselves are through our energy-entities of cosmic origin, as likewise the world itself which gave us life when æons of time had fashioned, and by no crude haphazardry, the conditions when the biped could evolve, that is, live, move and have a being.

The Libra, Leo, Taurus or the others walk throughout this life and play each their part, small or great, good or bad, but always with the characteristics and temperament of the class to which the date of their birth inevitably assigned them. The psycho-analyst would do well to take this into account, and before making his analysis; moreover, however strange or fantastic it may seem now, the day will come when this fact will be recognised and utilised by the medical profession.

Tarsier, homo, homo-sapiens, says the biologist, is our origin. The physical or organic origin of the biped, perhaps!

It will be asked here at what period, then, does the Primary Physics claim that Man became a spiritual entity or being? The answer is very simple—obviously at no specific period. The entity was always conscious and striving ahead, as it were, of its organic limitations or body—this can be seen even in the infant—the spiritual being merely a higher quality of consciousness. Just as consciousness is restricted by the organic limitations of each organism and is constantly endeavouring, through its at first limited spiritual powers, to override these limitations, in the initial stages through the multiplication of its organs, so is it possible, when the organism reaches the complexity and versatility of the human being, for the spiritual development of the energy-entity to take place freed from the restrictions formerly imposed by the lack of organs, thus promoting the full development of the brain, but always in accordance with the *free will* which is our heritage. Hence the spiritual development can be good or bad, or possibly cramped and restricted by the imposed will of others or that of a community or circumstances.

It may be true that the ordinary man (if such exists) is largely the product of his environment, but the great spirits are not; they make the environment for the ordinary man.

The important point here is that the spiritual and the physical in organic man are not separate conditions, any more than they are in the cosmos; they are inevitably blended because they are the product of the biomagnetic force which has in it consciousness (or the spiritual quality) and the physical.

It builds worlds and simultaneously imbues them, and thereby all resulting products of such worlds, with spiritual consciousness. Death of organic life provides material and ensues due to the process of sub-division of cells, which has its limitations.

And here we reach the main point which concerns us from the medical aspect—that Man is primarily a product of the biomagnetic force; he is thus a materialised condition of the energies with form, built upon his origin state, which is the conscious energy-entity frame or magnetic stressfield. He is now a spirito-physical being existing in the cold cycle, hence he must carry his warmth with him in the form of food, and so far as regards purely physical considerations he functions as an internal combustion engine, his temperature of combustion on the Fahrenheit scale being approximately 98.4° , whereas a plant or tree, for example, exists or operates in the warm cycle and draws its energy directly from the earth, the sun and air also playing their parts.

So man's "energy-frame" is biomagnetic, and since he is a source of magnetism he is surrounded by a magnetic field, just as a current-carrying wire is surrounded by a magnetic field, the difference, however, being that man's field is biomagnetism whereas the field round the wire has only the characteristic of magnetism, latent, within it.

If a man lies prone in a complete state of rest, restricting the circulation neither by physical constriction nor mental effort of any kind, but gently interlocking the hands over the solar plexus, and allowing the feet just to touch one another, there will be in due course a biomagnetic flow through the body, producing warmth and promoting circulation by

the most natural process possible. That this is magnetism is proved by a simple experiment. If a very small cardboard cross is balanced on the point of a needle with negligible static resistance, the needle being contained in a cork or other suitable means, the cross will revolve when the hand (with the fingers closed and slightly bent) is brought into close proximity, provided always that the back of the hand is uppermost. The cross will revolve either way according to the direction from which the hand is brought to the cross. The cross revolves through biomagnetic repulsion, all possibility of air currents having been first eliminated. When the hands are closed this force is available for re-energising the body.

Much more powerful is the force caused by a simple embrace between the sexes, as here there are *two like sources of energy in unlike condition*, creating, in this case, a bio-magnetic PD.

In both of these cases the circuit and flow is biomagnetic energy and not electric potential.

Surrounding the whole frame or body of a human being, or indeed any living organism, is the biomagnetic stressfield, the energy which gives us "contact-sense," by which we feel and judge the presence of another individual or substance. The judgment which we pass may be that we are indifferent to, charmed or unpleasantly disturbed by, this or that person who was with us.

It may be asked whether this judgment which we pass on some person with whom we came in contact is reliable. The reply is, only relatively so, as the measure which each of us applies is not a basic or universal one but our own standard, and even this is partially vitiated by the prevailing mood.

The speaker at a meeting feels the resultant radiation from the stressfields of all the individuals present—a tremendous force—which, if he knows his business, he will endeavour to synchronise with his own frequency or pulsations, and thus produce a thought resonance which will enable him to give his best or even to make a super effort and bring his meeting to a highly successful conclusion.

Each of us, when we enter a room where a few people

are gathered together, unmistakably feels the presence of the individuals in question before they have had time to show character either by gesture or speech.

Certain people, the genuine ones, possessing real clairvoyant powers, can, when requested, instantly and accurately describe people whom they have never seen and in considerable detail. They speak here of the "aura," which is really the biomagnetic stressfield, the person whom they are describing being presented to them in the energy form, through the pineal gland. This gland was once man's principal method of vision but has largely fallen into disuse owing to the domination of purely physical examination, to the total exclusion of the biophysical. (Appendix (10).)

The important point here is *that we are biomagnetic stressfields*, and this is the starting point for the subject of the new radiology made possible *only* by the application of the Primary Force, qualified from a specially charged Schappeller Stator.

In support of this may be cited, but very briefly, a few findings of the Beit Research Committee of the British Homœopathic Association, the results obtained being from strictly "orthodox" biophysical and physical methods (after Prof. Boyd, M.D.):

- (1) The body-mind inter-relationship can be shown by psycho-galvanic reflex to be objectively demonstrable throughout by cathode ray, oscillograph and suitable amplification.
- (2) The electrical activity of the body can be shown in various ways by different biophysical methods:—
 - (a) There is an electric field surrounding the body extending in every direction, modified by environment, affected by such actions as passing near other people, and having a fluctuation quality.

This can be demonstrated qualitatively by suitable apparatus, entirely objective in character, recording on an oscillograph.

(Where electric potentials actually exist in the

body their source is nevertheless the biomagnetic field; these are, however, converted into the electric current by the apparatus used—the wire circuit converts magnetism to electricity by “energy-compression.”—See Chapter on Electric Current.)

(b) The body emits continuously radiation in the long infra-red region, which can be filtered by various crystals and detected by delicate thermo-junctions.

(These and many others not cited are the biomagnetic reactions to the present “orthodox” purely physical instruments. What interesting discoveries will be made when the real biophysical instruments are available and can be placed at the disposal of these researchers!)

The four artificial sources of radiation and the purpose for which they are applied have already been given. These sources of radiation are all at least foreign, if not actually poisonous, to the delicate biomagnetic energy of the human being, as are, of course, also deep X-ray and radium emanation in cancer treatment. They often destroy and thus cure a local cancer, but unfavourably affect the surrounding tissue and in some cases give a radium cancer or the like on or near the periphery of the cancerous growth.

There can be no dispute as to the poisonous effect of radium on the human being, because those who work with a minute particle of this dangerous substance always require a great thickness of lead as a protection and even then give the warning that it is dangerous to expose oneself too long to its radiation. Excessive X-ray exposure is known to cause disintegration of the human body, and the smallest burn from an arc lamp is very difficult to heal.

For this reason no such lamp for radiology should be available for the lay public to treat themselves. Stimulation in the form of radiant energy depends, like all other forms of therapeutic treatment, on the condition of the body at the time, and should be a matter only for skilled diagnosis.

*THE APPLICATION OF THE PRIMARY FORCE TO
DIAGNOSIS AND CURATIVE TREATMENT.*

It must be clearly understood at the outset that this depends firstly and lastly on the actual production of the Primary Force (as detailed in Part II, The New Technique), and of course exhaustive experimentation with its application to the above.

The application for curative purposes will be through what is now termed radiology, but using biomagnetism instead of the devitalised biomagnetic source of radiation available at present for this purpose—the electric current.

Let us first of all consider the physics relating to this, which can only be dealt with very briefly here.

What are waves? What are particles?

Professor H. A. Wilson, F.R.S., made the following interesting statement, some years ago, but it is still largely if not entirely relevant to-day:—

“The state of optical science at which we have arrived in the last chapter was described by an eminent physicist when he said that we think of light as particles on Mondays, Wednesdays and Fridays, and as waves on Tuesdays and Saturdays.

“To this we may add that on Sundays we admit that only God knows. . . .

“The particles, like waves, are hypothetical, and only the effects produced are observed. . . .

“The assumption of waves and particles helps us to understand what happens, to some extent, although we have no idea why or how the particles are guided by the waves. The waves and particles are purely imaginary. They are crude models of the underlying reality which they perhaps resemble slightly in some way which we do not understand.

“We can calculate what will happen when a very large number of effects are produced, but the symbols representing wave-lengths and other quantities not observed, in our mathematical formulæ, probably really represent quantities quite different from those suggested by our crude model. . . .

“When we are trying to explain any phenomena the best we can do is to imagine some combination of things with which we are familiar, such as waves and particles, which seems to work in accordance with the facts, and if we are successful then we have a more or less satisfactory theory. But the underlying reality probably consists of things quite different from anything we are familiar with, and so we cannot hope to get anything better than a crude model.

“Such models are probably about as much like reality as shadows are like the objects producing them.” (A simile the author himself used previously in this book.) . . .

“Quantities which cannot be observed, however, are really meaningless and the particles themselves are never observed, but only the effects which they are imagined to produce.”

Waves and wave-lengths are therefore a method or system of measuring radiant energy, something which within certain limits we term colour or the ultra- and sub-spectrum beyond it. We are, as Professor Wilson says, at the best simply measuring the changes in the shadow, and what is the substance but biomagnetic radiation in the vitalised or devitalised secondary state?

Colour is not merely wave-length; wave-length is only a measure of colour; colour is a characteristic conscious expression of this biomagnetic energy in the form of radiation, measured at present by wave-length and frequency and to which the human eye is only sensitive to one octave.

The origin of colour lies in the sense-energy of the Ether and is the psycho-physical expression of it. Pigments are an impregnation in the secondary state of this sense, which takes place when all the necessary chemico-physical conditions are present.

The pigment, for example, in the substance of the iris of the eye is variously coloured in different individuals through the function of the sense-energy (biomagnetic conscious energy in the secondary state), and is often deposited after birth, as a characteristic of the organic body. Blue eyes do not necessarily bespeak blue pigment. In newly-born European

children the colour of the eyes is often slate-blue owing to the black pigment at the back of the iris showing through.

Colour does not "enter" at any point or period of time into the scheme of things during the formation of a new world or earth. Colour is a characteristic of the biomagnetic force which finds its expression only as and when the right conditions obtain which, as has been previously explained, applies also to organic life itself.

The sun's spectrum has its origin in the sun, but the spectrum we see is not necessarily directly due to the sun's frequency, occasioned by the functioning of the sun's entropic spiral, but modified by the lag of this frequency through the crossing of the sun's and earth's stressfields which produces light, of which each colour is a component part of the whole. The lag is due to the formation of light-matter (measured at present in photons) through energy-compression.

All radiation is the result of energy-compression and the total compression of all components or colours gives white light. The components or colours are measured at present by wave-lengths—being the purely physical measure of a biomagnetic phenomenon.

A scientist engaged in medical research has expressed the opinion that there is probably, in the physical world, and for the purpose of his present researches he includes a super-physical world, some form of spectrum which "is not electro-magnetic in character but which has similar properties." Exactly so; in the "super-physical world" it is bio-magnetic in character, blended with the physical properties, some of which are measurable with the present secondary instruments; whereas, in the physical world, it is bio-electro-magnetic in character, in which again only the physical properties are at present measurable—that is, of course, if we must postulate two worlds where only one actually exists, as Nature is one unity and does not function in water-tight compartments.

If, however, the scientist defines his super-physical phenomena as those phenomena which do not react to present secondary instruments, the expression is perhaps

allowable, but still dangerous as it gives a misleading impression of a dual world instead of unity.

There is actually only one spectrum and it is bio-magnetic or bio-electromagnetic, but always "bio," as is every other phenomenon in Nature, and those phenomena which cannot be measured by present instruments do not require to be classified as "super-physical," not to mention supernatural, merely because of this.

There is not the slightest logical reason to doubt that when the proper bio-physical instruments are available the bio-physical characteristics in the physical and "super-physical" world will be measurable, as consciousness existed even before energy-matter. (See earlier Chapters, Part I.)

All these new bio-physical measuring instruments have to achieve is to extend the octave of human sight through the use of energy lenses in place of glass lenses.

Frequency is the ultimate measure of origin thought-impulse, and the biomagnetic spectrum (and there is no other) has thus properties other than those of nodal points and static fields, which former, however, can be detected and measured when the biophysical instruments are available.

We are, however, here at the moment concerned more with the psychological effects and meaning of colour.

Different individuals are affected by different colours according to their sensitivity. Colours can affect our moods, and moods brought about by other influences actually affect the colour-tone of our stressfield.

Every characteristic man possesses must have its origin or equivalent in the biomagnetic energy, the source of man's organic origin.

But man is neither a physics nor a chemical laboratory, therefore if we radiate light of various colours upon him his mood would change only in proportion to his sensibility to any given colour—a somewhat inadequate test to apply even for the secondary Physics. The Primary Physics deals with a man as a bio-physical and a bio-chemical problem—an advance on these lines has already been made in medical research, referred to again shortly.

The correct word for protoplasm is really "bioplasm,"

and this leads us to the most complex and mysterious part of man's "make-up"—it may be said that "make-up" is not a scientific term; maybe not, but here it is infinitely more accurate than mechanism—the brain.

Thought-impulses, which are conscious energy pulsations, may enter the brain in three different ways:—

- (1) From the complementary Ether stressfield, usually in a semi-conscious state of sleep, when they may be communicated to the so-called sub-conscious mind, which in the semi-conscious state is linked closely with the conscious mind or brain-functioning; and such thoughts, sometimes, when the right conditions obtain, may be retained by the brain after complete consciousness has been restored, and reproduced or memorised at will.

The thought-impulses are recorded as energy-impregnations. (These energy-impregnations on the brain will actually be made visible by the new Schappeller microscope.)

- (2) The second and usual process is that of thoughts recorded through conversation or the written word. The recording on the brain is a series of energy-compressions arising from the thought-impulses crossing the cohesive force of the brain material, and:
- (3) The reverse process takes place when the brain reproduces these thought-impulses, that is, when it memorises or thinks. (See Appendix (11).)

(1) and (2) are thoughts from external sources, whereas (3) is the equivalent of starting up the record in a gramophone. Here the man sets himself to reproduce, that is, to convert the thought-impregnations on the brain into thought-impulses, or to make new impregnations by inducing original thought-impulses himself.

Thinking is thus achieved only through a series of energy-compressions, which, if sustained, causes fatigue, the equivalent of fatigue caused in materials through sustained stress and particularly through alternating stress reversals.

The thought-impulse in man, induced from exterior sources, or reproduced by man's conscious effort, affects mood and the whole chemico-physical condition of the organic body, according to the degree of sensitivity of each individual to the quality of such impulses, but not necessarily directly in proportion to changes of frequency, as thought-impulse is bio-physical and is also related to quality in that it is blended with the spiritual, which cannot *at present* be measured by frequency or wave-length.

The physical result or reaction of such impulses has actually been registered in advanced researches (see "Electro-Encephalogram in Cases of Cerebral Tumour," *Proc. Roy. Soc. Med.*, Vol. XXX, No. 5, March 1937, Walton), in which it is shown that the brain activity is accompanied by electric potentials of periodic varying character, well known and detected by modern methods of encephalography.

This is, of course, conversion to electric impulses through the medium of the particular apparatus used. (See Appendix (6)—Blausen experiments showing atmospheric biomagnetic stressfield measured as an electric potential.)

It may be asked, and this is important, *what does it matter whether it is termed electric potential or biomagnetic stress?* The reply is fairly obvious: the term "bio-physical" has been given to researches connecting "body, or body-mind activities, with electrical or, more broadly, bio-physical phenomena"; it will therefore be clear that if the basic energy in organic life is electrical, that is, devitalised energy, organic life as such could not exist and the suffix "bio-" in bio-physical phenomena has no meaning.

Qualitative Energy.

The bio-physical energy has quality, and here is the basis for the new treatment through the application of bio-magnetic energy produced as is explained in detail in Part II, "The New Technique."

Radiation in the form of a concentrated biomagnetic stressfield derived from the glowing magnetic core within the Sphere of the Stator can be directed on to the delicately sensitised biomagnetic energy frame, the organic body being

saturated and vitalised by a like force, because every organism on this earth is a product of this life force from the earth's central core and surrounding stressfield. The Stator is a replica of the earth's core and the quality of energy radiated therefrom can be varied to suit any purpose, *i.e.* production of power, mechanical or electrical; light or heat; or curative treatment, by varying the quality of sublimate in the Stator field. (See Part II.) Stimulation from this can never be anything but life-giving and result in regeneration of the whole system.

This is bio-physical treatment by the same energy as that which is indigenous to and vitalises the blood.

The analysis of blood is very complete, yet not even one drop can be synthetically produced—hence the necessity for transfusion—because it is a product out of an organic factory, like milk. The missing ingredient in blood analysis is the biomagnetic energy just as it is in milk. The Stator supplies this, the ultra- or “universal vitamin” necessary to the organic life of man. But even the biomagnetic force from a Stator could not enable either blood or natural milk to be produced, because they are essential sublimates out of stressfields bound and completely united to organic bodies.

This form of radiation *will have both a physiological and psychological effect*, it will stimulate the nervous system and the vital action of the entire organic system, tone up the functioning of each organ and also the whole conscious ego. There is nothing mysterious about this; it is not supernatural but supremely natural, because it is the same condition of energy which produces and vitalises organic life.

So much for man in health, but what is the effect of this treatment when disorder sets in through any cause and the inevitable result of neglected disorder—disease?

The biomagnetic force combats its opposite. This is not a mere statement; it is demonstrated in disease, which is simply a combat between living forces, whether they are active in the form of viruses, bacteria or radiations harmful to organic life.

It may, with justification, be contended that harmful and deadly bacteria, which cause disorder, disease, and

finally death in man, are also presumably actuated by the biomagnetic force. Precisely, but here we have to introduce a factor which present Physics has no means of measuring and therefore has apparently no alternative but to ignore it, viz. quality, which does not react to any of the purely physical instruments at present available. Quality here means "sense-energy," or the conscious functioning of the biomagnetic force. This is a selective force. The biologist himself speaks of "natural selection" as being an indisputable fact, but apparently to him it is an inexplicable phenomenon. There is an old saying that "what is born in the bone comes out in the flesh." Does Science ever ask what is born in the bone, and how? The whole skeleton is a product of the biomagnetic force and is impregnated with the faculty of consciousness, particularly the spinal column. All the qualities which man has are derived from the biomagnetic force which is in every particle of his blood and organic being. (See Appendix (2).)

The biomagnetic radiation from the Stator (see Part II) can be made selective to the preservation of man's organic life and deadly to bacteria or foreign conditions (malignant growths, etc.) subversive to it.

It can be used in even a more advanced manner, but that is outside the scope of the medical application.

Malignant growths would offer a resistance to this radiation and would be broken down, as they are by present forms of radiation. The surrounding periphery would, however, be vitalised instead of devitalised as at present, new disorders often resulting from such devitalisation. Malignancy in the whole system can be eradicated, because the radiation would also be used, although at a different potency, on the whole body, and not, as it must be at present, restricted to the affected area only.

It may be asked, if the biomagnetic force cannot fail, whether man will ever die—presumably he will live for ever when this new form of radiation is available, as he can be constantly and permanently rejuvenated!

Man himself will not die, but organic man must, because material, or the process by which material exists or

is rejuvenated, has its limitations. Sub-division of cells or a like process has its limitations. It is not hyperbolic. The asymptotes are finally reached, and the asymptotes here are organic death. The point is that radiology equipped with Stator radiators will place in the hands of skilled medical men an effective form of surgery without the knife and medicine without the drugs. It will also increase the length of life and reduce the decay period of old age, because rejuvenation or revitalisation will be possible closer to the limitation of sub-divisions.

This does not mean that surgery with the knife will be entirely obsolete; obviously not. For example, amputation of limbs will still be necessary, relief of pressure on the brain, etc.; in fact, surgery will still be required for mechanical damage through accidents or defects from other causes which can only be removed by mechanical (surgical) means.

Neither does it imply that drugs will be obsolete—no such prejudiced statement is intended; but it does signify that all such present means as deep X-ray and radium will be eliminated. On the other hand, diathermy will still have its useful application.

As regards the electric current, this can be produced from the Stator, but it will be of exactly the same devitalised quality as that produced at present because the electric current has no quality, it has only characteristic. The therapeutic action will therefore be purely for producing as at present a hyperæmia, if such a method is still necessary in certain cases.

But the biomagnetic radiation will provide a natural tonic to the whole system far superior to anything available at present, both physical and mental, because it is itself the life-force. Furthermore, through adjusting the composition of the sublimates in the Stator field it can be made specific to the individual both mentally and physically, and in cases of disorder or disease specific also to the complaint—a matter, of course, for prolonged research and experimentation when the Primary Force has been produced and is available for medical application.

It may be contended that general references are not

sufficiently specific, that page and line should be given in all cases, as busy researchers have no time to read through "voluminous details." More haste, less knowledge. The author's advice here is, be content to "hasten slowly." This is a new subject and a vast one, there is no royal or privileged road to this knowledge, it must be assimilated slowly. Any single statement or statements may prove misleading, the basis of the entire subject must be absorbed *as a whole*.

It is not a question of how long this takes, but of how thoroughly it is accomplished.

The origin of the biomagnetic force must be understood, and thus its functioning, and, above all, *that it is the conscious and thus the qualitative force, and that its quality can be varied to suit specific conditions and individuals according to astro-physical type, age, ailment, environment, both mental and physical—these are the essentials*; these factors and others will, with the aid of the new Medical Stator, constitute the future practice of therapy, however odd or fantastic it may sound at present. Furthermore, there will be the new biological instruments which will afford a method of diagnosis far in advance of that available at present, as has already been briefly explained in connection with microscopes.

The Nature of Biomagnetic Radiation as a Stressfield.

The author made the statement that "wave mechanics" is dead. He meant by this, not that it is useless but that it takes into account only the physical phenomena, since waves themselves are not energy, they are at the best only a system of measuring energy in radiant form.

The nature of the biomagnetic energy must be studied from the earlier Chapters.

As regards the system employed to measure it, present units for the application to mechanical power are used at this early stage, but eventually the bio-physical instruments evolved when the Primary Force is actually available will enable new units to be employed, as has been previously explained.

On the other hand, electrostatic fields could not vitalise a conscious being, but Science at present can see only electric

currents, electrostatic fields and secondary heat, merely because their instruments transform all energies into one of these secondary forms, or because these secondary forms are produced by the organic and other physical conditions, but the actual origin energy operating in any organic life, and producing in certain cases secondary energies, is bio-magnetism.

As we have seen in previous chapters, especially that on the Electric Current, electricity is highly-compressed, potentised magnetism but not biomagnetism—or the “bio” in the electricity is latent. In other words, all forms of energy can be converted into heat or electricity when the right conditions obtain, as has been explained at length in the earlier chapters of Part I.

Thus skin potentials, electric fields and their functioning, such as have been discovered and measured in the advanced researches of Professor Boyd, owe their origin to the bio-magnetic energy-frame of the body and its biomagnetic stressfield functioning as a vacuum force; conversion to heat or electric potential, static or otherwise, being either a secondary action due to the functioning of the organic body, or, as has been explained, to the actual apparatus used in measuring these phenomena. (See Chapter on the Electric Current.)

The source of electricity is always magnetism in the polarised or impolar form. Here it is impolar as a stress-field, its functioning being due to the entropic spiral, as organic life is bio-physically poised in the fundamental energy cycle—but this must be studied in Part I.

THE PRIMARY PHYSICS EXPLANATION OF SEX DETERMINATION IN THE HUMAN SPECIES.

There is no haphazardry in Nature. There is in Nature no coincidence, only co-incidence. Everything functions exactly according to plan. The plan is complete, determined and prescribed to fulfil the purpose for which it was created. But the plan is not mechanical. It is spiritual. Therefore, the propagation of the species (especially the human species)

is not a mere aimless and endless process to be continued until that particular earth or world disintegrates.

It may be said that here, as in astro-physics, there is no alternative as a basis for present scientific examination but the analysis of physical phenomena with the instruments and means available, that Science would cease to be Science if it were to indulge in philosophical speculation; or in other words, that the physicist who obtains his data direct from experimentation, then checks and establishes it by mathematics, or in some cases by the reverse process, cannot make any use of so-called "metaphysics."

The author is in entire agreement with this, but the restrictions which are imposed on scientific investigation at present do not exist in the Primary Physics. And the true scientist will always be ahead of his instrumental research; his fertile and elastic brain will not be a mere storehouse of so-called "established facts" but also an experimental laboratory, otherwise his work will always be retrogressive, introspective into the technique, rather than progressive towards origin.

The exact reasons why a Creator or All-Pervading Consciousness, whose sublimite is the conscious Ether, exists, were given at length in the early Chapters, likewise the nature and functioning of the All-Pervading Consciousness through the spirito-physical laws. Briefly stated, without a Creator nothing could exist—this is quite obvious—and a Creator does not create without an eternal and lasting purpose, as man would if he could. Flushed from his triumphs in the Secondary Physics and corresponding techniques, man expresses the belief that one day he may be able to produce life (human life) from the test-tube, no doubt with the aid of enormous electric voltages in accordance with the frightful fallacy that "electricity is life." It is not; it is devitalised energy, as electro-therapy admits and demonstrates. So without even the crudest understanding of the Universal conscious biomagnetic force (the origin of life), he is going to "produce life," ignorant of the fact that "life" is not a product but a "creation." So man is going to turn creator, and humanity would suffer the supreme

calamity—spiritual death—but fortunately he cannot create and the world will thus be spared the propagation, or rather the perpetration, of an inhuman species, the human cycle being an organic derivative of the fundamental cycle, governed and controlled by the spirito-physical laws and Time Factor.

The aimless and endless evolution and functioning of worlds may be all that Science can see, but such a purposeless, sterile, aimless, endless evolution is hardly to be ascribed to the Seat of all Consciousness, the Font of all intelligence, spiritual and physical. And the propagation of the human species, with which we are concerned here, is no exception; it is part of the plan, and the solution of this problem lies in the understanding of the ultimate purpose of that plan, in which the physical aspects are secondary. The span of man's organic life may now be fourscore years and ten, nevertheless, rather a trivial period for such an elaborate evolution required to produce him.

Hydration and dehydration, the spermatozoa and ovum, genes, gametes and generators had to be created first in the energy form, and they are the conscious-physical permutations in the secondary states of matter, arising from the Primary Law and plan. The plan is exact and determined, *but one factor is free will* in organic life, hemmed in by certain spirito-physical restrictions. If free will did not exist it is quite obvious that the term "natural selection"—so conveniently adopted by scientists to evade, but thereby to admit, the awkward fact of conscious-physical energy—would have no meaning.

Natural selection is a basic law of life, not merely of organic life. It is thus part of a plan, but it is also *the cause of the seeming haphazardry and confusion in the plan and purpose.*

Now what is the ultimate purpose of the plan?

It is simply the ultimate perfection of the energy-entity—the real man—which must and can only take place through the individual effort of that entity to uplift itself, since it has been accorded "free will." This effort, and the sacrifice which this effort entails, automatically draws the assistance and help required through the process of transpiration

(mobile energy exchange—conscious and physical) from the fundamental source of all power—the Creator as such.

Sex exists as a basic law, not merely in organic life; here it is manifested to us in what we term the material form. If it did not exist basically it could not exist materially. We are concerned here with the material aspect.

No child can be born without the energy-entity being present in the mother, because there would be no pattern on which to weave the body by transpiration, and the “weaving” could not take place unless the energy-entity itself were a biomagnetic vacuum force. (See Appendix (2).)

Emerson says, “The power which resides in the newly-born child is new in nature.” This is quite true, because it is an entirely new *organic* entity, but the entity, ego, or being itself, is not new merely because it is clothed in organic form.

Certain entities have been accorded the power to choose their parents-to-be, which will place them exactly in that position in organic and communal life to fulfil the task or purpose allotted to them—however small or relatively unimportant that purpose may appear to be. The opportunity is there and how they perform it is not only their affair, but their responsibility.

In such cases the sex is directly determined, *i.e.* the chemico-physical condition of the parents will be such as to produce the male or female child required, and, furthermore, conjunction between the parents will take place at the time favourable to this, owing to the synchronous working of the Time Factor, because the plan is conscious-physical and not merely physical.

The reproduction of the species is not a physical but a bio-physical phenomenon, but the physical reactions can be measured by the present crude instruments, within certain limitations, the picture presented, however, is astigmatic, distorted and restricted.

Other entities are not so favoured as those previously mentioned, but in either case there is no haphazardry, merely the elasticity of free will, permitting natural selection and conscious functioning.

The schedule of the ultra-initial stages of the propagation of the species is somewhat as follows—the actual process being, of course, one of enormous complexity of action and interaction, as it is with every bio-physical process, much of which, as has been explained, is of necessity hidden from the present physical or so-called bio-physical researches:

SCHEDULE OF PROPAGATION.

Life is polarised yet enters at the neutral:—

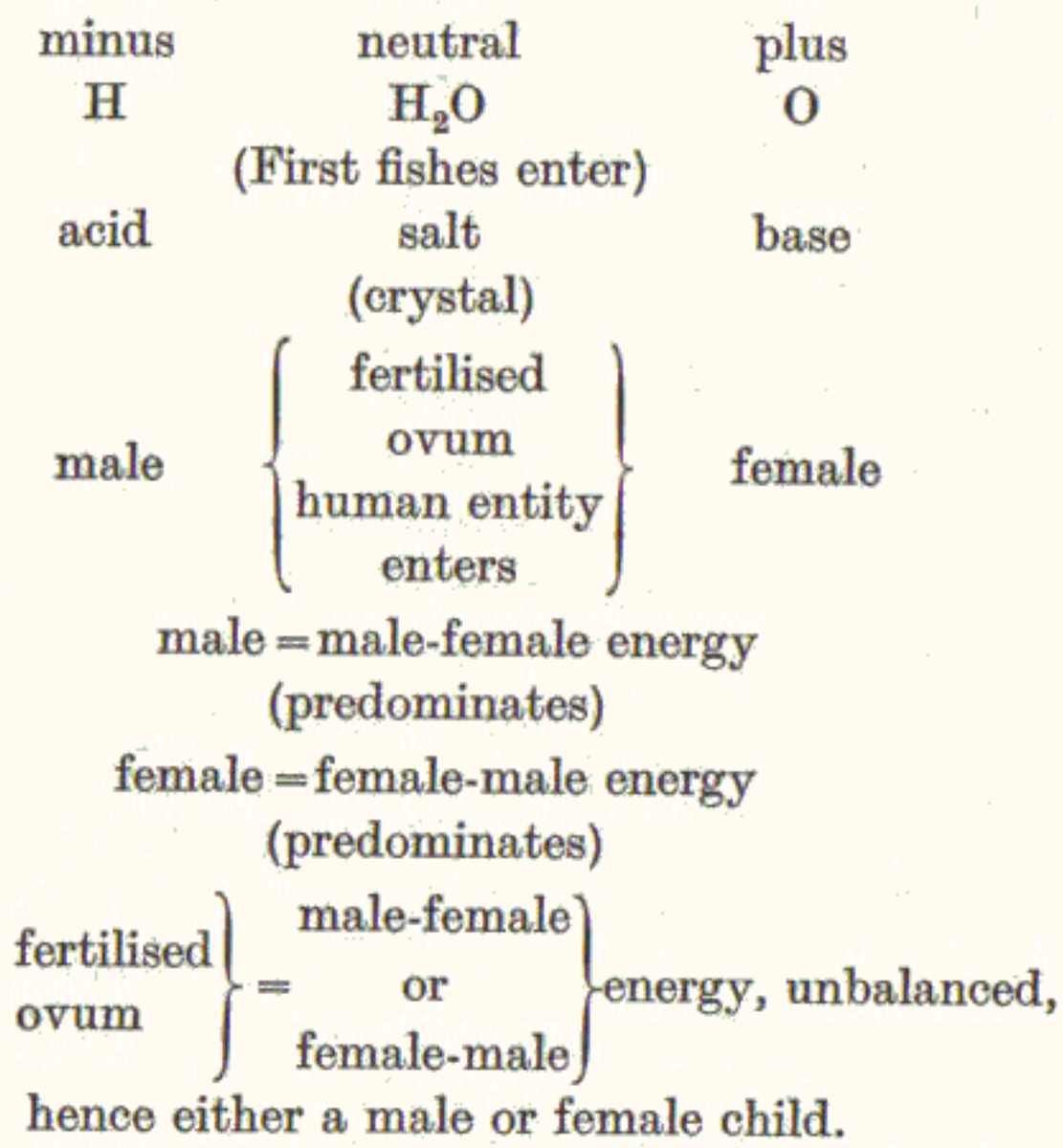

Note.—In border-line cases, where the percentages of male and female energies are nearly equal, the child may change its sex.

BACTERIA, ETC.

Where do bacteria enter in the plan?

Bacteria are minute unicellular *vegetable* organisms. They are organic catalysts. Now the Primary Physics shows that the origin of all material is organic—although the classification for purposes of chemical analysis and manipulation into organic and inorganic is perfectly

legitimate as technique, but only if we realise that the origin is organic. The Primary Physics also shows that all substances are previously derived from successive polarisations and permutations, the first polarisation producing the first catalyst (in energy form—glowing magnetism), the sun. Later polarisations, permutations and combinations must be occasioned by energy catalysts, say, alpha rays—helium nuclei—isotope of hydrogen (the same catalyst as in the sun's core but in quite another form), as a derivative radiation. Finally, there are organic catalysts—micro-organisms, bacteria, and variants, *e.g.* enzymes. In the Primary Physics these will probably be classified as organic agents. The latter could not form or be sustained until the earth's crust had reached a stage when vegetation existed, *i.e.* when the compacting, temperature, and physico-chemical processes could have clothed these bacterial entities and sustained them as organisms.

But here again it must be emphasised that it is of necessity a process with enormous complexity of action and interaction, requiring an exhaustive knowledge of mobile exchange and the functioning of the sense-energy, which the new biophysical instruments will demonstrate and measure.

At present all this has to be examined by instruments (voltmeters, ampère meters and the like) which function on a devitalised biomagnetic force—the electric current—and biologists, bacteriologists and astro-physicists are restricted to instruments (microscopes and telescopes) furnished with glass lenses. Hence, the scientist even of to-day sees “as through a glass darkly,” and, as it were, “men as trees walking.”

SUPPLEMENT

SUPPLEMENT

Time.

Schappeller defines time as "impulse with specific purpose."

Now we saw in the text that basically everything, *e.g.* force, energy, matter (as energy or material), in fact, everything which exists or can exist in the Universe and beyond, is an inseparable blending of consciousness and the physical.

Language at present is rather like a card-index system—it pigeonholes our thoughts. The physical is the "physical"—the tangible; the conscious (or spiritual), if not actually chimerical, is certainly "intangible." Yet the five senses with which man is endowed, *e.g.* sight, hearing, smell, taste, and touch, are all due primarily to consciousness—but blended with the physical. They are all biomagnetic faculties, which exercise the conscious and, in the higher forms of life, the spiritual judgment, through the already defined sense-energy. Nevertheless, these five senses are themselves "intangible," yet the physicist uses them all in his laboratory. Thus, in the "exact Physics" the intangible faculties are used to examine the tangible or physical.

Time, then, is "impulse with specific purpose."

In our present language the author would therefore define it as "the conscious component of frequency, functioning through and with the physical component."

Let us take an example of this: different frequencies or wave-lengths give us different colours, but frequency and wave-length are directly related to time, and colour here is the conscious expression of the energy in radiant form.

Einstein discovered that Time is an essential factor in astrophysical measurement, but apparently he regards and handles it as if it were a mere physical factor, whereas it is a bio-physical or conscious-physical factor. This subject in man's Science is termed astrophysics—in Nature itself it is astro-biophysics.

Another definition which Schappeller uses to define Time is "happening" (*Geschehen*), which is the result of the functioning of *biophysical Time*.

Time in the primary state is the cause of the birth

and death of cosmic worlds, not the end of their conscious and physical inter-relationship, but that of their conscious-physical inter-relationship.

The fundamental or basic language is, of course, the language of the cosmos itself, which the energy-entities use, and in that language our word "Science"—translated into our language—is termed "etheric," because everything originates from the conscious-physical Ether, and so the knowledge of the Ether and its functioning is "Etherics" ("Science") and the conscious-physical functioning of the Ether is "Time."

It may be contended that earlier in the book the functioning of the Ether was expressed quite differently. Exactly so, but it was also explained that *Nature is one unity and that there is only one truth, but many manifestations of it*, and in order properly to analyse each manifestation it must, on each separate occasion, be expressed differently. But the result of such analyses is like the Alexandria cross-stanza—which ever way it is read, it reads the same.

The Origin of Life.

The Physical Origin of Life, if we must for initial clarity put it that way, is due to the implosion of carbon energy static, or carbon brought to the glowing state as polar-impolar biomagnetism. This is the origin of life, not of organic life, but of life or consciousness as force or energy—thus not the origin but the "essence" of organic life.

The division or polar separation of carbon energy static into its two constituents, hydrogen and oxygen energy, is the "energy-soil" for organic life.

The Conscious Origin of Life is, of course, from the same source, since carbon energy static is "conscious-physical."

Man is an ultra-life product out of a specific reproductive cycle. The instrument of procreation is always the entropic or weaving spiral; in the Primary State, its product is mobile exchange or energy-weaving, finally resulting in the building of an earth's crust; in the secondary state it is organic weaving—the weaving of a material body on a conscious-

energy frame, in other words, the formation and development of the foetus.

The spirals and entities are inductions from the Creator, the Universal thought-vacuum, the *Dei Vacuum*.

Socrates said that every grain of seed or "sowing corn" has within it the consciousness of the plant-to-be and everything which grows thereon. He was really describing the energy-entity frame but without specific knowledge of its existence.

From the physical, or rather the bio-physical standpoint, man is *a condition of the energies with form*, and as such he is a product of the tomistic force (mobile exchange force) and the static Ether.

First energy, then gas, then liquid, and finally the solid form—the sequence is exactly the same, *in principle*, with man: he is a densified materialised stressfield. The living earth is the same but in another form, and both are surrounded by their magnetic fields. But man is an ultra-product of the living earth. Living, moving, thinking man, a conscious-physical being, could not be the product of a dead earth. Life could not "teem" on a dead earth. The central core of the earth is glowing biomagnetism—conscious energy—the origin of all life.

Ask yourself this question. Are the five senses conscious or physical? Is "touch," for example, physical or conscious, or both? Obviously, it is both. And what are the five senses, and from what are they derived? They are the conscious-physical expression or manifestation of the bio-magnetic energy in man.

Sight reacts to *energy* radiation, and in man (and animals) is directly due to "light" radiation from some exterior source crossing man's biomagnetic stressfield—it is this which functions the optical and colour apparatus contained in what we term the eye. But sight depends on "consciousness"—the unconscious man cannot see, although his sight apparatus is unimpaired. *The faculty of sight is therefore conscious-physical*. The crossing of the two stressfields produces energy impulses through energy compressions in the sight and colour apparatus of the eye, which are then

transmitted through the nervous system to the static energy of the brain, and are reproduced there as an "energy picture." This is *what* man sees, this is *how* man sees—*this* is sight. And this is why perfect functioning and co-ordination of the visual apparatus and the brain is essential to perfect sight. Fatigue of either or of the transmitter—the nervous system—instantly impairs the acuity of vision.

Hearing is similar, but attuned to a low frequency—elaborated later.

Smell requires transmission by the vapour state. But vapour is, or contains, water, and is therefore biomagnetic, latent within itself, but capable as such of stimulating consciousness. The unconscious man cannot see or smell. Both faculties are the result of energy transmission through the physical.

Taste and *Touch* require the liquid or solid states for contact. These two faculties are both biomagnetic in essence, and are linked by this to the conscious ego. The unconscious man cannot see, hear, smell, taste or feel; these are biomagnetic faculties any of which may be developed to an art, or super-faculty. And this art is inherent in the ego—it is the self-expression of the energy-entity. Mozart played the harpsichord at three years of age, and Beethoven the violin at five. That art which a man has none but his Maker can teach him, and his Maker teaches him through induction from the energy-entity or ego. Man only wonders at, reveres and fears the unseen. Why is not life in the organic form as marvellous as life in the *unorganic*? In the *inorganic* form it is latent as material. Why is that which we cannot see any less real or necessarily more marvellous or less natural than "the seen"? Man's physical sight is only one octave but his conscious sight could be practically unlimited if only he would use it. "Unless ye see, ye will not believe," and he only "sees" one octave, because his spiritual sight or understanding is dormant. He is not dead, but sleepeth. Let him awake through the New Science, which is merely the new knowledge of the Creator within him, expand his sight to the *ultra* and the *infra*, indeed, to the whole grand spectrum of Divine manifestation, the

heritage which he has cast aside; then his Physics will become all-embracing, universal—in fact, Science.

Pain—The nerve system is a system of energy transmission.

Let us take an actual example: suppose a patient suffers from an incurable disease, all the doctor can then accomplish is to reduce, or better still entirely stop, the pain during the period in which the fatal disease runs its course. Now, if it is found impossible to stop or even reduce the pain of the affected organ, locally, the only alternative at present available is to call in the neurosurgeon, who severs the nerve at the point where it enters the spinal column—naturally, the sensory nerve only, not the motor nerve. If this is successfully carried out the patient will never suffer pain from this cause again. There will probably be some temperature effect, but he will, since the motor nerve is still intact, have the full use of his limbs so far as he enjoyed this previously to the operation.

The lesson which this teaches us is of great importance. The pain here was restricted to a local organ. This pain does not travel up the nerve system through the spinal column to the brain. The patient only felt the pain in the affected organ, yet when the sensory nerve was severed the pain ceased. Here is the conscious, as it were, separated from the physical and travelling on the conscious-physical energy of the nervous system, the equivalent perhaps—if a very crude simile merely for illustration is permissible—of the wattless current in the electrotechnique travelling on the cohesive force or static energy of the wire.

In other words, the pain from a local disorder or disease is not communicated to the brain, but only “the consciousness of it,” the brain itself being insensitive to pain—the principle of the anæsthetic.

The Brain is the seat of consciousness of the skeleton and the man as a whole. It is a biomagnetic sponge—the equivalent in the electrotechnique of the core of an electromagnet saturated from its solenoid, but in the latter case with latent or devitalised magnetism from the electric current.

The brain receives its impressions in various ways:

internally and basically, from the energy-entity frame; externally, from the sensory system or "energy telegraph" (the nervous system of the body); and finally, direct from the earth's thought-stressfield surrounding the earth's periphery, where the "future" is evolved from the past and the present by the Time Factor, thus:

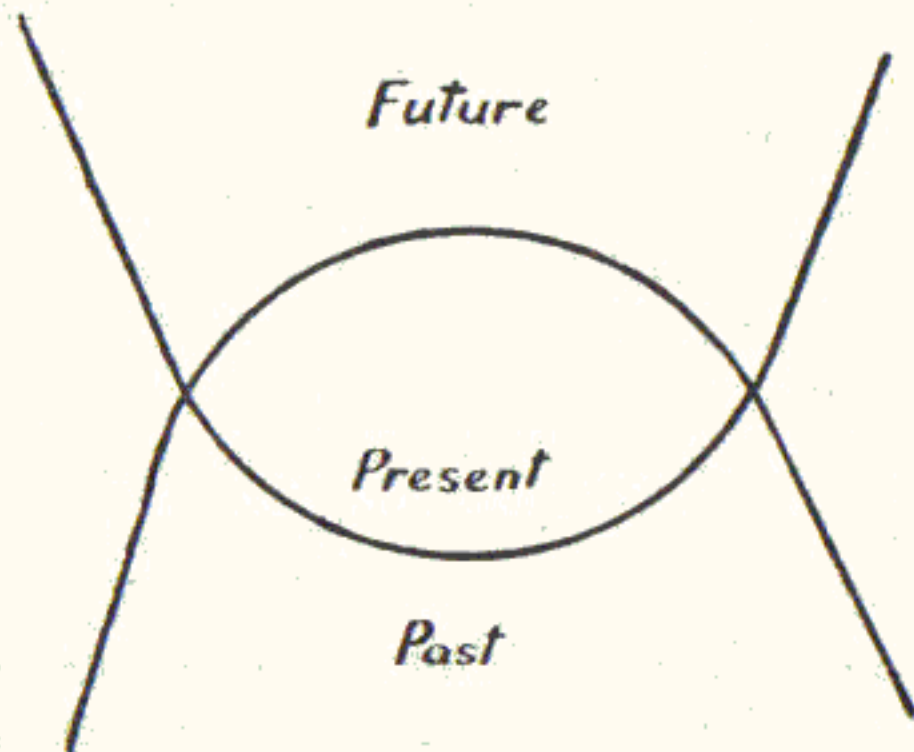

FIG. 20

the great interlinkage of Time, Place and Circumstance, where Conscious Time and Evolution are Cause and Effect, functioning always with consistency of purpose—the creating, building or evolving of a New Age.

Thoughts, great or small, are also transmitted to man from this source through the pineal gland, in the twilight of sleep (or semi-conscious state), or under special circumstances and in specific individuals even during full wakefulness.

The brain can receive and retain thousands of impressions and not only discriminate between them but, normally speaking, recall each one at will, simply because they are "energy impregnations." The actuating needle is the thought-impulse, the particular record is the particular thought-impregnation to be reproduced. If they were anything else but energy-impregnations not only would confusion of thought ensue, but memory and the whole thinking process would be blurred.

The brain records thought-impulses, and therefore the corresponding records or impregnations on the brain are

energy-impregnations which will be visible under the new Schappeller energy-microscope.

Similar conditions exist even in the mechanical instrument which we call the gramophone.

This is explained by *mechanical indentations* made by sound impulses on the gramophone plate—reverse the process and the same frequencies are reproduced, thereby giving the same sounds. But a series of violins in an orchestra or the delicate tones of the human voice would not be reproduced by such “crudity” alone.

The real explanation is that the static energy or cohesive force of the gramophone plate has been impregnated with or scored by the cohesive force of the needle through the aid of what we term “mechanical means,” and the recording on the brain is similar, but without “mechanical aid.”

Professor F. W. Lanchester, F.R.S., in his elaborate exposé on the “Musical Scale,” speaking of the ear, says:—

“The ‘ear,’ in its widest sense, is a highly complex organ for the reception or transmission of sound, its message being conveyed by numerous nerve fibres or neurones; the whole may be compared to a telephone system in which sound, passing into a receiver, is conveyed and distributed through a more or less complicated disposition of exchange and line wires. . . . Of the ultimate destination where the message is delivered little is known; still less is known of the psychic ‘beyond’—the sensorium—in which mere complex sound (after preliminary analysis) is interpreted as music capable of stirring the whole nervous system in a hundred different ways; of that we know nothing at all and probably never shall. That is the ‘Holy of Holies’ at the portal of which the ear in its widest sense delivers the message, but beyond which it has no place.”

Here again is the “energy picture” in “hearing,” reproduced to the energy-entity frame—the “Holy of Holies”—which reacts as did “sight” through the whole nervous system in a “hundred different ways.” Either sight or hearing can engender concord or discord; horror or charm, love or hate, but the important point here is that although

any given sight or sound will submit a similar energy picture in every normal individual, this same energy picture will produce (due to other complications) entirely different emotions in various individuals, and will be modified by time, place and circumstance.

This digression was necessary and therefore permissible, because no sound instrument is of the slightest value without the conscious-physical organic receiving instrument with which man has been supplied—the ear.

The Analogy of the Gramophone.—The gramophone plate is a “binding medium for sound waves,” that is for energy impulses, which manifest themselves physically—in our present terminology—as frequency, within the limits of what we term “hearing,” and which are subjected to energy compression by the cohesive force of the needle; these compression impulses are then reproduced by a sound amplifier of suitable and convenient form as speech or music.

The force which binds the sound waves is present in and common to all materials, the cohesive force, but it is not necessarily equally sensitive for this purpose in all materials; here the chemico-physical condition of the material in question is important.

The resistance, and there must be a resistance in order to obtain a “permanent impression,” is the cohesive force of the recording plate, which is the same force as that of sound itself, the two, however, being in “unlike condition.” If this were not the case, the energy frame or cohesive force of the plate could not bind the sound waves, and this applies equally to the functioning of the brain.

Sound is simply “sight” at another octave, requiring another form of receiver. It should not therefore need a great stretch of the imagination or impose too great a strain on the credulity to visualise a new instrument, which will enable the whole keyboard of frequencies at present known, and perhaps frequencies far beyond these limits, to be translated, not necessarily into so-called seeing, hearing, tasting, or feeling, but to “conscious reception” of the appropriate form.

It is desirable here to compare the views of another

authority (Prof. Sir J. Arthur Thomson, M.A., LL.D.*) with those expressed by the author on the origin of life and its characteristics, etc.

Quoting from his book, *Scientific Riddles*, he says:

It is the very essence of evolution to be *integrative*, to build up higher and higher wholes, and, as General Smuts put it: "Matter, Life and Mind, so far from being discontinuous and disparate, appear as a more or less connected progressive series of the same Process."

Perhaps we make the unsolved problem of the origin of Life more difficult than it really is by forgetting that it must have been not merely a biochemical but a biophysical synthesis.

Life is an activity *sui generis*; for the formulæ of matter and water (say, electrons, protons, and electromagnetic radiations or ether waves) as at present understood do not describe

- (a) the everyday functions of the body in their orchestration, or
- (b) the activities of any organism at any grade of being, or
- (c) the purposive behaviour of higher animals that are well-endowed with brains, or
- (d) the phenomena of development and heredity, or
- (e) the supreme facts of evolution—which are still in evidence.

Every biologist recognises that processes and functioning of life are so far analysable into chemical and physical processes; yet these are modified by their occurrence in the colloidal medium of protoplasm. Moreover, when the chemical and physical ledger is added up, it does not give us any unified description of what has actually occurred, let us say, when a migrant bird makes its annual journeys. For to describe these

* Late Emeritus Professor of Natural History, University of Aberdeen.

it is necessary to introduce concepts like enregistration of the past, awareness of the present, and purposiveness towards the future. In at least the higher reaches of the Animal Kingdom, behaviour is correlated with psychical activity of organisms which require concepts transcending those of mechanisms, chemistry, and physics, helpful though these are.

He continues, in referring to the characteristics of living creatures:—

Thus under the general quantity

(A) of *persistence amid unceasing metabolism*, there is a triad of facts:

- (1) the upbuilding that compensates for the down-breaking of protein,
- (2) the occurrence of these proteins in a colloidal state, and
- (3) their specificity from type to type.

(B) The second triad of qualities includes the organism's characteristic powers of *growing, multiplying and developing*.

(C) In the third place living creatures are contrasted with non-living things by their purposive behaviour, by their power of enregistering their experience and by their capacity for giving rise to the new—a third triad.

He sums up the characteristics of organisms as follows:—

(A) Persistence of integrity and ceaseless change, there being

- (1) a self-preservative compensation of down-breaking by up-building;
- (2) a metabolism of proteins and other complex substances in a colloidal state, and
- (3) a chemical individuality.

(B) A triad of linked capacities:

- (4) growth,
- (5) multiplication and
- (6) development.

- (C) The crowning triad of
- (7) effective behaviour,
 - (8) enregistration of experience and
 - (9) evolvability.

He declares that in (C) the mental aspect seems to struggle for expression throughout, and to many of its investigators the organism appears as a psycho-physical being now Mind-body and again Body-mind.

The teachings of the Primary Physics are precisely the same, but expressed in other words and much more basically, viz. that the conscious-physical is perfectly blended and inseparable, *even in* (so-called) non-living things where, however, it is latent as cohesive force. As has been pointed out, the word Mind is too vague to be used in scientific analysis unless it is defined.

Protoplasm.

Speaking of protoplasm, he says that probably the largest splash of fairly pure protoplasm that can be readily obtained is a quaint creature called Flowers of Tan which has not yet made up its mind whether it is a plant or an animal.

He further affirms that there is a general inclination to regard protoplasm as a subtle mixture of proteins, carbohydrates, fats, water, and salts, plus ferments and other subtleties, but that it is not a witches' cauldron, it is a chemical firm, perhaps with a sleeping partner called "mind"—for it may be that there is no life without a mental aspect.

This is exactly one of the points the author made, that there is no life without "consciousness," and that this consciousness is derived from the universal conscious-physical energy, or biomagnetism, the origin of life as energy, as entity, as organism, and as matter. But, as matter, it is latent as cohesive force—what may be termed the static or dormant state of life instead of the dynamic states as in organism, or as energy entity, or as in origin functioning of cosmic variants.

Referring to the Origin of Man, Sir Arthur Thomson contends:

We must be loyal to what seems to be a fact that man emerged gradually from a stock common to him and to anthropoids; but we must be loyal to the other facts as well, and we must refrain from hurrying to conclusions in regard to the factors that may have operated in the marvellous ascent. Nothing that Science knows is against philosophically or religiously interpreting the "humble primate animal" as on the way towards the fulfilment of a Divine Purpose.

This statement, if carefully analysed, will be found to be practically identical with that expressed, but in much greater detail, by the author, on page 286.

APPENDIX

APPENDIX

(1) *Size of Sun and Subsequent Earth* (Part I—IV and XX).

If, as the Primary Physics suggests, a sun can form a crust, provided that at some period the right conditions obtain, the question arises as to what were the relative sizes of the sun before and after it subsequently formed an earth. For example: our earth has a radius of about 4,000 miles, whereas the present sun's radius is about one hundred times this figure, or 400,000 miles.

Suppose the sun were to form an earth whilst at its present size, which is about 8×10^5 miles diameter, or, say, 1.3×10^6 kilometres, then presumably it would form a point of inequality in Space at a distance equal to the square of its diameter in kilometres, which would be approximately 1.64×10^{12} kilometres, and a new sun would form here.

There are several possible answers to this problem.

- (1) A sun, on becoming an earth, may produce a new sun of greater or lesser magnitude than itself. This would depend on the curvature-form of the sun's field at the time when it was forming a crust, the formation taking place thus:

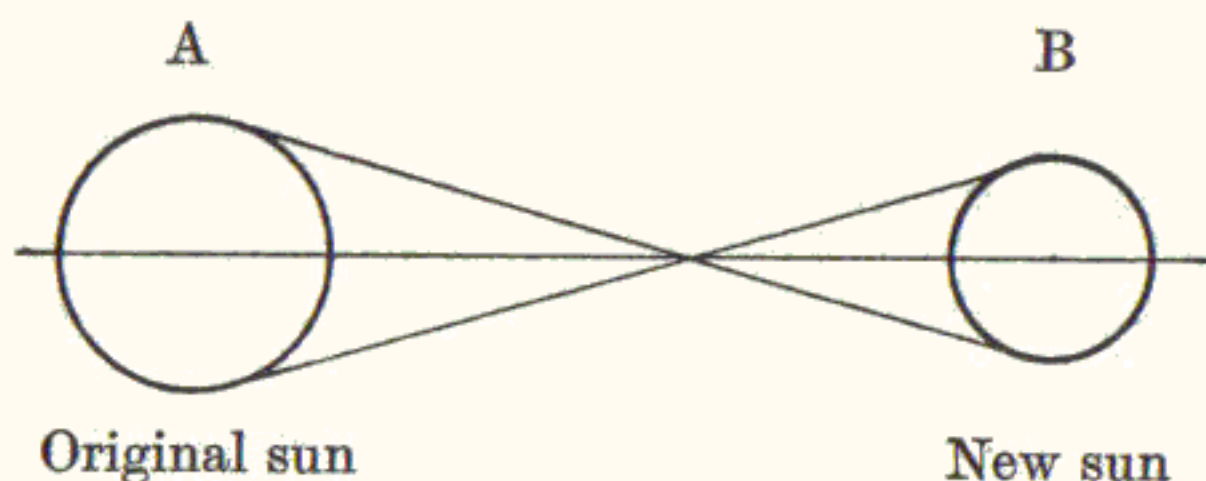

FIG. 21

Or the reverse conditions obtain where B is the original sun and A the newly formed sun.

We must not overlook the fact that we have van Maanen's star, which is about the size of our earth, and also such stupendous giants as Betelgeuse.

The particular form of magnetic concentration at the time when a sun is forming a crust may produce a new sun or other variant of one of the forms classified by astronomers.

- (2) Whilst it has been pointed out that the sun is not losing bulk at the calculated rate because it is "feeding" on its stressfield, it does not follow that it could not be growing smaller.

It is obvious that if the rate at which it is feeding is less than the loss by radiation, then it will reduce in size.

The rate at which it feeds will be controlled by the frequency of the entropic spiral, and the frequency of the entropic spiral will be a function of the mass, form and nature of the new sun or other variant and the conditions under which it was formed. (See Entropy, Chapter XXII.)

- (3) All cosmic bodies are not formed by this basic method of polarisation of the two energy components of the ether, followed by conglobation of the hydrogen component—a cosmic body can be born directly from a sun. The important point here is that, however it originated, every cosmic body—*e.g.* sun, earth, or other variant—must be composed of a central core of glowing magnetism, *i.e.* conglobated hydrogen in the energy form.

- (2) *Models and Growth* (Part I—XIV—99–101 and Part III—263—3; 297—6; 304—2).

All growth is the product of the functioning of the fundamental cycle. This is, as it were, Nature's "cyclotron"—growth is energy catalysation within a potential difference with "models."

Growth in Nature, as has been explained in the text, is the weaving of an organic body on to an energy entity frame by entropic action, whether the frame is a plant, insect, animal or human child (page 106, para. 1).

Here the energy entity frame is the "model," which is not a product but a "creation." It is for this reason that "life" cannot be produced by man. Man can only bring about the conditions in which the natural forces can operate, and thereby produce or reproduce, either by the means provided by Nature through sex functioning—a selective and therefore a conscious-physical act—or through what is termed in the Primary Physics "models," where the desired product is one of the so-called elements, *e.g.* gold, silver, copper, etc. The Creator alone can create—it is His prerogative. Man lacks the "model," the spirito-conscious-physical energy entity frame—the creation!

Frequently we see assertions by eminent physicists that they hope eventually, with the aid of so-called vacuum tubes, immense voltages and "watt"-nots, to produce a perfect race of men—*mens sana in corpore sano*.

By all means let us strive towards this ideal, but not with test-tubes and devitalised forces. However paradoxical it may sound, it is nevertheless an undeniable fact that many of the greatest men of our age—and, indeed, of all ages—have had to combat and subjugate great physical disability. This very disability was the "test-tube" in which the spiritual effort (arising from the functioning of the energy entity frame—the ego) was made and enabled them through spiritual combat against their physical handicaps to acquire the strength to fulfil their Creator's plan and render humanity some ultra or lasting service.

Scientists tell us that it takes a million years or more to harden the ruby. Nature's test-tube is thus Time and Effort. In the case of human beings the ingredients are spiritual, the sound mind is obtainable only through sacrifice, and the sound body is largely a product of discipline.

So to promote growth Nature uses the fundamental Potential Difference in the primary or secondary conditions, but always with patterns or models.

In "cosmic bodies" the pattern or model lies in the conscious hydrogen core, formed by the conscious Ether and the cosmic Time Factor, perhaps predestined for spiritual organic life, or for a lesser purpose such as a balance factor

for inter-cosmic mobile exchange to effect synchronous dynamic of some Cosmic System.

In organic cycles, as has been explained both here and in the text, the model is the energy entity frame; it may be said that in the tree it resides in the planted seed, whereas in the human child-to-be it is in the foetus, and so forth, but even this is surely an invert image of the true facts. It is the seed, foetus, or equivalent, residing in or built on the energy entity frame, which contains or is in energy form the complete organic product whether this is to be a plant, tree, insect, fish, animal or human child. It is the stressfield and pattern on which, through potential difference and entropic action, the organic body is woven and through which it lives, moves, and has its being—the spirito-conscious-physical entity or ego. This is why no two human beings, plants or animals can ever be alike, each and every one is a different entity, although possibly of the same species, from the same mould, matrix or mother. The origin of everything cosmic, or in the evolution of the species, is the energy entity frame, the pattern or model without which there could be no evolution, no growth, no organic life and thus no matter (as material).

In the reproduction of materials or the so-called elements there are merely the remnants of the entities concerned in the progressive evolution. For example, gold, silver, copper, etc. are not basic; none of these exist as such in the cosmos. It may be contended that several of the elements have actually been discovered in the sun. Certainly, but these are the energy radiations of such elements, the result of the polarisations and permutations from the two basic components of the Ether, H and O energy. Nevertheless, there is a long ancestral history from that to the respective materials known as gold, silver, copper, etc.—herein lie great secrets quite unknown and unsuspected by present Science. Tracing each of these, from their origin-energy to the respective materials known to us under these names as the elements, was part of Schappeller's work, the bulk of which he retained as his secret, which he would know how to use if and when conditions and circumstances

were such that he could carry through his main purpose and object—the actual production and practical utilisation of the Primary Force.

Now, if we wished to produce any of these substances, say, gold, we must of course first produce the Primary Force (glowing magnetism). For this we require Schappeller's complete energy condensation plant into which we must insert a small particle of the particular model required, in this case obviously gold.

Material has been defined as being the product of a growth between a potential difference, the pattern or entity being present; an organic energy entity, if organic life is to be the product, the process then being possible only to Nature herself. If, however, only a material is required, then the pattern or model may be a particle of the material in question, the potential difference being supplied by the Primary Force or glowing magnetism, the weaving machine being "transpiration" effected through the energy-condensation plant, which draws up the energy from the earth through the particle and characterises it, in this case with gold entity, thus promoting the growth of the gold particle (as a seed grows into a plant or tree) and finally condensing it in bulk to the solid form.

Growth in Nature is virtually the same process but with a living entity, producing a conscious or physical organism, whereas, in the case of materials, it produces not consciousness but latent consciousness or "characteristic." The characteristics of the various elements are quite different, but nevertheless specific. This branch of the work would be disclosed at a later stage, and other branches which as yet have not even been mentioned as they are too advanced and would, in the initial stage, lead to confusion of thought over the whole matter.

(3) *Special Explosives* (Part I—XIV—101—3).

There are explosives which contain no nitrogen, *e.g.* carbon and liquid oxygen. But, from the point of view of the Primary Physics, CARBON ENERGY is composed of its two components, oxygen and hydrogen energy, although

this fact is not made manifest when screened in the secondary states of matter.

There are also explosives which contain no oxygen, *e.g.* cuprous acetylide—composed of copper and carbon. Heat, friction or shock will bring about molecular disruption of this compound and transform it into solid copper and solid soot. Here, however, we have not an explosive due to the formation of gas; in fact, as no gas is formed the disruption of the molecules is not in itself the cause of the explosion. It generates a considerable amount of heat, causing rapid expansion of the surrounding air, and thus what we term an explosion occurs.

(4) *Nature of the Elements* (Part I—XV—106—1).

Since every energy entity is a magnetic or, rather, a biomagnetic conscious-physical structure and stressfield, it follows that its counterpart in material must be a latent biomagnetic structure where “characteristic” is substituted for “consciousness.” It has been explained that even the so-called elements are not elemental (and present Science has proved this now), and that each of these has an ancestral line from which it originates, so gold, silver, copper, etc., in fact, every substance, must be the product of a series of entities, which gives each substance its different characteristics. The characteristic structure of the crystal of a substance is the physical evidence of this. If we desire to have the bio-physical evidence we must then disintegrate the substance by the method which will be available in the Primary Physics, when each stage of its history will be revealed. Crystallography is thus really the study of the resultant magnetic structures upon which each material is built and which arise from the series of remanent energy entity frames co-ordinated through Time and ever-changing chemico-physical conditions that have finally built up a “characteristic substance” which we now term copper, gold, zinc, etc.

(5) *Planetary Motion* (Part I—XXI).

It has, it is hoped, been made amply clear that although Schappeller in his Primary Physics establishes that the sun

revolves round the earth, Schappeller's planetarium is neither the Tychonic nor the Ptolemaic System. Nevertheless, the question will arise in the minds of some readers: if the sun revolves round the earth, what are the relative motions of the various planets? The motions of the planets are just as fully accounted for on the Tychonic or Ptolemaic Systems as on the Copernican System but the first two systems (the sun revolving round the earth) break down absolutely when they have to explain the *aberration of light* and the *annual parallax of the stars*, both of which phenomena are actually observable with modern instruments.

Aberration of Light.—This is described as being *the apparent displacement of a heavenly body, due to the combination of the orbital motion of the earth with the velocity of light.*

Now it is quite obvious that any planetary system must eventually be able to offer an explanation of the aberration of light with reference to the fixed stars, and neither the Tychonic nor Ptolemaic System has been able to do so.

It is true that Schappeller's planetarium establishes that the sun revolves round the earth, just as is the case with the Tychonic and Ptolemaic Systems, but here the similarity between these two systems and Schappeller's ends. In Schappeller's planetarium we have a fixed earth's crust, but the magnetic field of the earth having its origin in the central magnetic core (of glowing magnetism) revolves with or rather is revolved by the sun's revolution round the earth. Furthermore, Schappeller establishes that light does not come from the sun as such, but only as energy radiation (electromagnetic radiation, if you will). The author believes that this fact is already known to astronomers.

Schappeller also evolves the theory that energy transmission by the ether is not restricted to the speed of light in air or in a space without air—an artificial so-called vacuum. We know that the speed of light varies with different mediums through which it passes, *e.g.* glass (the principle of the lens), likewise water and gases, air at different temperatures, etc. Energy transmission through the energy membrane or ether is an entirely different phenomenon, at least according to the Primary Physics.

In Part I it was explained that the phenomenon of light as we know it is produced by the crossing of the radiation or stressfields of the sun and the earth through energy compression on the earth's periphery. The same, of course, applies to all light received on the earth. The constant of aberration for all stars is about $20''\cdot47$, which is the angular measure in seconds of the time lag due to the finite speed of light as such and the orbital motion of the earth. In the Primary Physics, however, in relation to a star it is due to the crossing of the stressfields of star and earth and the time lag may be at least partly accounted for by the period required for the formation, or rather the transformation, into light through energy compression, as is explained in Part I with relation to the functioning of the stressfields of sun and earth.

Schappeller's Planetarium.—To recapitulate: a sun, as it forms a crust—that is, as it is becoming a newly forming earth—concentrates its magnetic field at a point in space about the square of the distance of the earth's diameter in kilometres, thus inducing at that point an inequality in the homogeneous ether causing conglobation of the hydrogen component, followed instantly by polarisation of the two components due to the formation of the oxygen energy component around it—spherical polarisation.

This phenomenon has obviously an immense significance in the planetary system as a whole. It means that every time a new sun is formed a new system is born, which may involve other heavenly bodies that previously belonged to other earth or solar systems (according to whether the Schappeller or Copernican System is accepted).

In this connection it is at least interesting to note that modern astronomy has shown the similarity between the systems of Jupiter and the sun and likewise of Saturn and the sun, and the author is of the opinion that these two systems joined or were caught in our present system (solar or earth's system) at the time when our system formed—that is, at the time of the formation of our present sun on the lines already detailed above.

The Annual Parallax of the Stars.—According to the

Primary Physics the formation of the sun as explained in the previous paragraph instantly involves "two likes in unlike condition," the law here being that one must move. The sun is formed from the Ether and is in fact Ether densified to the glowing state and polarised as regards form (spherical polarisation of the two energy components of the Ether).

The sun or glowing magnetic core must move and, being born of and thus bound to the earth's stressfield, it must revolve tangentially around the earth. But unless some new discovery is made by astronomers it is apparently impossible to reconcile this with annual parallax of the stars, which is probably the most positive and incontrovertible proof that the earth revolves round the sun. There is thus a "missing link" here between the Primary and present Physics, but the author regards it as nothing more than that. Present Physics, to mention only one basic example, cannot explain the most fundamental phenomenon, viz. the cause of the gravitational force, what gravity is and how it originates. Furthermore, present Science completely fails to explain the physical origin of the sun nor can it offer a comprehensive cosmogony of the Universe which, as formulated by Schappeller, is the basis of his Physics of the Primary State.

(6) *Blausen Experiments* (Part I—XXIII—164, 167 and XXVI—199—2, and Part III—296—3).

Blausen's experiments were arranged to measure the PD extant between the earth's surface and varying heights above it—or so-called atmospheric electric potential. Actually, as has been explained in Part I, the earth's atmosphere is a magnetic stressfield arising from the central core. Now, if under the right conditions we subject a body to stress or tension we obtain electricity. Here the gas subjects a balloon envelope to expansion (tension or stress), which is saturated or crossed by the magnetic field latent within itself as such but arising from the earth's polarised core. The tensioned gas and stressed envelope are both crossed by the earth's field, so that here we have the crossing of these two stressfields and, provided the right apparatus (a circuit with suitable instruments) is available, the magnetic potential of

the atmospheric stressfield is converted into an electrical potential measurable in volts.

(7) *Radioactive Materials* (Part I—XXVI—205—1).

A radioactive element is one which, in addition to the properties of the normal element, possesses the power of emitting alpha- or beta-particles. In doing so the element breaks up to form a new element, or, as it is expressed technically, it disintegrates.

The alpha-particle is a double-charged atom of helium, equal in weight to four units, which is expelled from the centre of the atom at about 10,000 miles per sec.

The beta-particle is an electron, *i.e.* a rapidly moving single charge of electricity without mass—velocity from 50,000 to 186,000 miles per sec. This particle is sometimes accompanied by a very penetrating radiation, the gamma ray.

Now, helium is hydrogen in another form, so the alpha-particle may be said to be the hydrogen component.

The beta-particle is an electron; and if an electron is a particle of electricity, then the beta-particle or radiation is hydrogen and oxygen energy as homogeneous energy-mass, *but not in energy-combination*.

The gamma-wave is electromagnetic, hard and highly penetrative. This we may recognise as the carbon energy of the Primary Physics—that is, the alpha and beta radiant energy but *in energy-combination*, the equivalent in the secondary states (*e.g.* the gaseous state) of chemical combination.

Radium radiation is due to the over-filled cohesive force of the material, one particular substance or element having had an exceptionally high susceptibility to radiation from the earth's core which enables it to retain a quantity in excess of its cohesive force. Its cohesive force is thus over-filled and radiation takes place, and since it is absorbed into the cohesive force of the material radiation causes a slow disintegration of the substance. The rate of disintegration is known to be constant. It is unaffected by powerful physical agencies, *e.g.* enormous temperatures or pressures. This fraction for radium is 2280^{-1} per annum.

The particular substance is the so-called element uranium. The disintegration series being uranium-radium-lead implies that the only sources of radium in Nature are minerals containing uranium. In magnetism we have the permanent magnet, which, unless purposely demagnetised, retains its magnetic charge for a very long period of time; in the electrostatic sphere we have the similar phenomenon effected by electrification of an electret, the permanent magnet, so to speak, of the electrostatic sphere; here we have uranium as the equivalent in susceptibility to the Primary Force or radiation from the earth's core. Each of these three phenomena functions of course through its own respective technique.

Now, since the cohesive force in all material is the latent stressfield from the earth's biomagnetic core, it follows not only that the over-filling of this in the substance possessing high "susceptibility" produces continuous radiation, but also that the "superfluous" cohesive force which is absorbed into the cohesive force proper of the material must cause slow disintegration of the mass as radiation takes place. The disintegration is slow and constant because the material is still over-filled with cohesive force and thus radiant emanation carries with it only what might be termed the "disturbance factor." This, in its turn, is not a simple loss of H and O energy but of alpha and beta emanation, which therefore produces not merely a loss of mass, but a third substance will be built from this disintegration, involving moreover a change of state, viz. the gaseous element Radon. If this product happens like its parent to be radioactive a certain fraction of it will disintegrate in a unit of time to form another substance, and so forth till a substance is reached in which the "superfluous" or over-filled cohesive force is exhausted, when the substance will cease to be radioactive and this series of radioactive elements will end abruptly as lead.

Each successive disintegration, as we have seen, is accompanied by loss of cohesive force of the respective matter, and it is not therefore surprising to find that the end-product, lead, is softer than the hard white product,

uranium, from which it originated. There appears, moreover, to be little doubt that the evolution of heat by radium and other radioactive matter is mainly a secondary phenomenon resulting largely from the energy of the absorbed radiation. Here is an example in the secondary physics of energy radiation accompanied by a very small evolution of heat, such as we saw would be the case in the Schappeller Stator in the Primary Physics (see Part II).

(8) *Basic Explanation of Kinetic Energy (Einstein's formula)*
(Part I—XXVI—final paragraphs).

It has been explained that kinetic energy is the induction of the earth's magnetic stressfield—arising from the central core—into a mass, any mass, which is in motion. The larger the mass, the greater is the capacity for this induction, or absorption, of the earth's stressfield. It depends primarily, however, on the speed with which the body or mass is cutting the lines of force of the earth's stressfield, all of which accords with the fundamental energy formula $\frac{1}{2}mv^2$.

Einstein proves, according to the relativity theory, that the mass of a body in motion is equal to its mass at rest plus an additional mass exactly equal to the kinetic energy possessed by a body as the result of its motion, and he expresses this mathematically by his formula:

$$M_1 = M_0 + E/C^2$$

where M_1 = mass of body in motion
 M_0 = mass of same body at rest
 E = kinetic energy
 C = speed of light

Modern physicists contend that this simple formula expresses a physical fact, and Einstein declares that it is not merely approximately but exactly true.

Since the additional mass is proportional to the kinetic energy—as shown by the formula—the additional mass is obtained from the energy induced through cutting the earth's lines of force, *as this is the only energy available for absorption into the body in motion*, which according to the formula increases its mass.

(9) *Energy Entity Frame* (Part III—263—5).

When the author made the study of Schappeller's theory of the "energy entity frame" he realised that this original work would have to stand the test of scientific analysis and withstand the fire of scepticism, if not of derision. But "time marches on" and with it comes new light and new knowledge.

Modern embryology comes to our aid here.

Cell changes in animals and likewise in human beings, briefly stated, take place as follows:—

- (1) *The ovum* has at one end the animal pole with the nucleus and at the other end the vegetal pole with the yolk material. On fertilisation the cell tissue multiplies by mitotic division until it reaches (2)—a solid mass of cells, "the morula."
- (2) *The morula*—solid mass of cells.
- (3) *The blastula*—with central cavity forming.
- (4) *The gastrula*—when the dorsal lip of the blastopore forms and elongation of the whole cell mass follows.

Note.—This elongation of the embryonic tissue, which is the first sign of the formation of an organic being, could not take place due to chromosome activity alone, as chromosomes always split up into equal parts, *i.e.* into pairs or multiples of pairs.

- (5) *The neurula*.—The neural tube has now formed, which constitutes the backbone or spine of the new organism in process of formation.

Now how, according to embryology, does the organism, animal or human child, form? In other words, what determines the exact position of the various organs? As we have seen, the chromosomes are not responsible for the structural organisation. They merely ensure that the new organism is of the same species as the parents.

Embryology tells us that the structural determination is due to the "Individuation Field," which sets the organs as a "fate map." This, of course, is nothing more nor less than the "Energy Entity Frame" of Primary Physics, the actual ego, the organism-to-be, but in "the energy form," as is explained in Part I.

The embryological terms "fate map" or "individuation field" obviously bespeak or indicate consciousness, and the consciousness here must be in the form of force, and not force functioning through an organism but conscious force operating before the organism in question is in being. It is thus conscious-physical force functioning as such to weave tissue material to its "frame," and thus to build an organism—that is, to produce *organic* life.

This individuation field is therefore the conscious-physical *bio*-magnetic energy entity frame upon which, through which and by which organic life is formed. It is the "living pattern," but in the energy form only, that sets the fate map and determines the form and ego of the future organism-to-be. It is the individuation *stress*-field which, when the right conditions obtain, transforms the being from the energy state of life to the organic state of life.

When the organism as such dies, as we term it, the ego resides, as it did previously to its organic life, in the energy entity frame as the conscious directing force of unorganic life.

(10) *The Human Aura* (Part III—289—1).

Reference—O. Bagnall, *Origin and Properties of the Aura*.

According to Bagnall:

The fact that the human stressfield (or aura) exists has since been proven by a physicist who used Kilner filters to degrade the radiation to within the limit of the octave of human sight.

It was found that there were apparently two biomagnetic stressfields (or auras) surrounding the human body (or indeed any living organism). Both of these auras disappear at death.

The two auras are:

- (a) The relatively dense inside aura emanating from the body organs.
- (b) The relatively thin outside, or radiation, aura apparently emanating from the nervous system.

The inside or body aura (a) varies in brightness according to the individual's state of health. It was estimated as being about 6–8 in. wide and shaped to the body, except between the legs where there is no aura.

The outer aura or stressfield (b) surrounds the whole body in the shape of an oval mantle or haze. The colour is usually pale grey to pale blue. (Blue is considered to represent intellect.)

The *inside aura* (a) is the same for men, women and children.

The *outside aura* or *haze* (b) up to puberty protrudes only about 4 in. beyond the inside aura.

At 14–18 a woman's aura gradually widens until it attains 8 in. or nearly one foot in all from the body and becomes oval. The widest part is at the waist-line or thereabouts. The widening at the waist does not take place in the man's aura.

Inside aura (a) registers diseases of the alimentary canal and its glands, and among other things ill-health in general.

Outer aura or *haze* (b) is affected by nervous disorders or changes of sex.

In the case of the removal of any organ, such as the appendix, the inside aura in that vicinity disappears.

The inside aura (a) is attracted to either pole of a magnet; it is thus magnetisable but has no polarity; whereas the outside aura (b) is not attracted by any form of magnet.

According to the Primary Physics:

- (a) is thus an illustration of biomagnetic impolar magnetism, whereas
- (b) the outer aura is biomagnetism as a latent stress-field.

The aura arises, of course, from the energy-entity frame which, as has been explained, is itself the fundamental life-giving (or biomagnetic) stressfield of the human being. Since the organic body was woven on to it and by it, it is not surprising to find that the inner aura arises from the organic body and its organs, or that a second aura should exist extending beyond this and which does not follow the body contours but envelops the body as an oval haze, this latter being the outward expression, in radiant but latent energy form, of the ego, or biomagnetic entity frame, but in permeating the organic frame it becomes qualitatively influenced.

All this applies to animals and, in fact, to every living thing, but the quality of the energy differs although our present method of measurement, restricted to wave-length, may not disclose that.

At organic death both auras disappear, as they must, because the entropic spiral has ceased to function the body and the entity frame is no longer the source of a (biomagnetic) stressfield.

(11) *Memorising and Thinking* (Part III—295—1).

Memorising is the selective-conscious act of tuning the brain frequency to certain specific thoughts or energy impregnation frequencies until these frequencies can be reproduced.

Thinking is, or should be, the selective process of piecing together relevant frequencies both for form and quality in order to create or build up a new set of frequencies or thought-impregnations.

MISCELLANEOUS

MISCELLANEOUS

Matter, Cohesive Force, etc.

Sir Oliver Lodge states that Eddington, in 1920, in his work entitled *Space, Time and Gravitation*, defined matter not merely as causing but as actually "being" a variety of space curvature, and in terms of the tensor G_{uv} . The expression for it at that date was

$$G_{uv} - \frac{1}{2}g_{uv}G$$

Now we have seen that there is another and basic explanation for the curvature of Space. A universe or cosmos originates due to the formation of a point of inequality in the otherwise homogeneous static Ether, resulting in a "sphere of tension" which we term a cosmos or universe.

The texture of this newly formed cosmos is carbon static potential—Ether. The extent is Space. The form is spherical, because a point of inequality in a free homogeneous medium must produce a Space-form in which there is equal radial tension in every direction and the only Space-form which satisfies this condition is the sphere.

Matter as energy is densification of one component of the Ether after polarisation. The "Event" of such is due to the functioning of the Conscious Time Factor, the universal frequency, periodicity, which, when related to us on this earth, is termed "period" or Time, but having its origin in the All-Pervading Universal Thought-Impulse which formed this first inequality resulting in a universe or cosmos. Thus, according to the Primary Physics, matter, as such, could not possibly be curvature of space. Matter is the texture of space and space is tensioned to a physical centre, hence the reason why controlled-space or a cosmos is curved—because it is tensioned to a physical and thus to a geometrical centre. It is not even the curved quality of space which is, or which produces, matter; it is the radial tension to a physical centre that is the origin of the spherical space-form of a controlled-space or cosmos, the texture of which is then energy-potential static, as membrane—or what we now term the Ether.

The suggestion, therefore, that Matter is Curvature solves nothing, it merely gives a mystical quality to what we previously knew and recognised as a metrical measurement, whereas the Primary Physics, as cited above, explains why Space is spherical and thus why Curvature is fundamental to Space, but does not deduce from this that Curvature, as such, is Matter and thereby endow Curvature with an origin-quality which it cannot possibly possess.

Let us therefore be quite clear on the origin of matter and avoid this metrical confusion. It is the texture of Space—the Ether—which is origin-matter, but latent in form, the first matter as such being the product of the polarisation of the Ether resulting in the densification of the hydrogen component forming the core of a sun or other variant. This is the first not latent but active energy-matter. There is, as has been explained in this book, a long line of ancestry and biophysical circumstances from energy-matter to organic matter, and finally to what we term materials, *e.g.* gold, silver, copper, etc. The texture of Space, or membrane, is matter, but latent matter, stimulated. There are thus three kinds of matter. In the storehouse or ultra-Space, before the formation of a universe, the texture or matter is latent unstimulated matter. After formation of a cosmos it is latent stimulated matter, and when an inequality in the homogeneous Ether takes place, matter densifies and we have a precipitate of the latent stimulated matter which is then matter as energy in the glowing state. Finally, there is organic matter and the derivatives therefrom, but these we term materials.

Cohesive Force in Materials.

We have seen that this exists in Nature in the free state as a Potential Difference, whereas in material it exists in the frozen or bound state, *but it is not material*, it is the compacting agent which gives material space-form as a solid. In a liquid it is present as such, but it does not give space-form—a liquid being defined as a substance which takes the shape or form of its vessel or container. The gaseous state has already been discussed in the chapter on “Steam.”

MISCELLANEOUS

Now, if we take two elements at random, say, zinc and copper, we have the following data:—

Name	Symbol	Atomic Number	Atomic Weight	Valency
Zinc	Zn	30	65.38	2
Copper	Cu	29	63.57	1, 2

What does all this signify in the Primary Physics, *e.g.* atomic number, atomic weight, valency; and what relationship have they, if any, with Cohesive Force in materials? What is the unit of Cohesive Force?

We cannot dismiss the Periodic Classification of the Elements as being mythical. Science does not claim that it is basic but that it is at least a reliable working system. It must therefore have a meaning and significance for the Primary Physics.

If we say that the Cohesive Force of a material, which we have described as “the compacting force,” is exactly proportional to the atomic number, then lead and nickel, for instance, are tougher than iron, and uranium, being the densest material with the highest atomic number and atomic weight, may be explained as having the highest compacting or Cohesive Force. But this is leading us into a fallacy. Neither the atomic number nor the atomic weight is, alone, a measure of the Cohesive Force of material. Lead is a very heavy and therefore a very dense material but, unalloyed, it is pliable, showing an apparently low cohesive force.

Actually, the Cohesive Force does not bear a direct relationship to the atomic number, the atomic weight, nor to the valency, any more than any one of these bears any direct relationship to the stresses which a given material will withstand.

Just as the strength of a reinforced concrete structure to withstand any given stress depends on the structure or design of the reinforcement, so the Cohesive Force of the material depends on the kind of magnetic framework on to which it is expanded or contracted when the substance is changing into the solid state, and there is no “unit” of atomic or magnetic structure. Thus, material is not “just Cohesive

Force," but Cohesive Force is the compacting force of material, and the degree and quality of compacting depends on the kind of atomic structure of any given material to which it owes its hardness, durability and resistance to various forms of stresses.

Perhaps the nearest unit for Cohesive Force, using present units, is, in the free state, the ampère (see also Part II), but the Cohesive Force in material is latent or equalised out, in which condition none of the units in the electrotechnique could be applied.

It may be suggested that this is a similar condition to, say, the latent heat in thermodynamics, which is measured in calories or B.T.U.s with zero rise in temperature, or to the Decalescence or Recalescence of the Thermo-Magnetic Cycle in the hardening of steels (see *Engineering*, 1933, Vol. I, page 69), where change of state is accompanied by a slight rise in temperature and so the thermometric unit may be applied.

But the Cohesive Force in material implies no thermodynamic cycle nor change of state; there is no similarity between this and the two cited phenomena. The Cohesive Force brought about change of state, but it is a static not a mobile action and it is always interdependent on the atomic structure, or perhaps it would be more clearly and fundamentally expressed as the magnetic structure, of the material and its formation.

If a unit for Cohesive Force in material, and irrespective or even inclusive of the form of magnetic structure, is possible and necessary, experimentation in the Primary Physics, when the Primary Force is available, will indicate what the nature of this unit could be or is.

The Atomic Weight of an element was formerly defined as being the ratio of the weight of an atom of the element to that of an atom of hydrogen. Oxygen, however, is now adopted as the standard and the atomic weight is thus the ratio of the weight of an atom of the element to that of a 1/16 of the weight of an atom of oxygen.

It is thus a ratio and not a measurement of the actual mass of an atom, but it is a measure of the number of protons and neutrons in the atom.

The Atomic Number of an element is the number of unit positive charges carried by the nucleus of its atom—it is, or is proportional to, the number of protons in the nucleus of an atom.

An *isotope* of an element is formed by adding one or more neutrons to the nucleus of the element. And so we arrive at the exactitude of the Mendeleeff Table, the basis of modern chemistry.

The systematic grouping of nucleus and electrons in the secondary Physics, apparently involving electrical charges—positive, negative and neutral—arises actually from the absorption of the stressfield from the central core of the earth, which of course is magnetic (biomagnetic), but functioning through the secondary states of matter—the secondary states of matter being themselves the product of successive polarisations, permutations, and combinations, wherein the biomagnetic is latent and gives rise to characteristic in materials, the magnetic saturation from the core through these successive changes to the secondary states producing apparent electrical charges, and unit matter as material then takes a systematised form as expressed in the Periodic Classification of the Elements.

Cohesive Force is atomic force, it is the Primary Force in bound form, it is Vacuum; there is no other force—all other forces are derivatives of Vacuum. Gravitation is Vacuum. (See Chapter XXVI.)

Eddington, in his book *Space, Time and Gravitation*, page 190, makes the following statement:—

“The law of gravitation is not a law in the sense that it restricts the possible behaviour of the substratum of the world; it is merely the definition of vacuum.”

This is also true, but it is the fundamental biophysical vacuum, and it promotes the behaviour of the whole world system through mobile exchange.

Descartes said: “Give me matter and motion and I will construct a universe.”

Eddington suggests that this should be reversed to:

“Give me a world—a world in which there are relations—and I will construct matter and motion.”

The important point here is that both statements imply the necessity for “conscious action,” for to construct a universe, given matter and motion, or to construct matter and motion, given a related world, is a “conscious act”—a creative act—and the Creator is thus the All-Pervading Consciousness, and when the Creator produced a universe all the ingredients were already available for the functioning of the successive stages, as elaborated in Part I.

Eddington, in *Space, Time and Gravitation*, page 192, says:

“The matter of the brain, in its physical aspects, is merely form; but the reality of the brain includes the content. We cannot expect the form to explain the activities of the content, any more than we can expect the number 4 to explain the activities of the Big Four at Versailles.”

Exactly so; and what is the content of the brain? It is biomagnetism or the conscious-physical. There is no such thing as consciousness without the physical, they are complementary components of a whole, but physical does not necessarily always imply the “organic.”

Whichever way Science may trend, it will always be confronted with “biomagnetic origin”—first, conscious-energy (biophysical), then conscious-entity (life, but not organic), then organic life, and finally its derivative matter, as material, the product of life, death, and a potential difference.

Sir Oliver Lodge, in his book *Beyond Physics*, says:

“Life transmits no energy but exerts a guiding and directing influence. In association with form and waves it might do most of what is wanted. Gradually, biology and psychology may thus be allied to physics.”

The weakness of this statement lies in the specific use of the unspecified word “life,” which is left entirely un-

defined. As we have seen, the origin of all life is, first, life-energy (biomagnetic force). This force does not transmit anything, it is the origin of everything, although its functioning in the secondary states is screened and is not obvious without exhaustive study of the Primary Physics.

The word "psychology" may one day well become redundant, when all physics is recognised as being of bio-physical origin. Meantime, the word "life" is used by Science to cover the multitude of inexplicable gaps in our present knowledge. It is regarded as the unknown quantity, but it is no use to call it x and attempt to chase it to an algebraical lair. If, on the other hand, we were only to qualify the word as Nature has qualified this most fundamental of all phenomena, by speaking of life-energy, life-entity, organic life, to suit in each case the condition and manifestation of a particular life-form, both its origin and functioning would be understood, and the gaps in our present knowledge would at least be bridged, if they were not entirely filled up.

*Added 1946.—The Theory of Evolution of a Sun or Star
being*

A comparison between the most modern theory based on nuclear physics and that expounded here, in the Primary Physics.

Modern Scientific Theory

Primary Physics Theory

(For details see Part I)

- | | |
|--|--|
| <p>(1) ...</p> <p>(2) A star begins by the condensation of a large amount of matter at a point in space.</p> | <p>(1) The Ether is a homogeneous energy membrane of latent carbon static potential — the Ether being defined as <i>the texture of Space</i>.</p> <p>(2) When a point of inequality comes in the homogeneous Ether the two components of the</p> |
|--|--|

Modern Scientific Theory

Gravitational attraction contracts this cluster of matter. The thermal energy generated through this contraction or compression enables interaction to take place between protons and deuterons present. When all the deuterons are exhausted, contraction again takes place.

This second contraction causes a great rise in temperature and the thermal velocities of the protons are then great enough to permit interactions with deuterium, lithium, beryllium and boron.

This is known as the "giant stage" of the star.

When all the above four types of nuclei have been consumed, further contraction follows and the temperature again rises.

The carbon cycle now commences which supplies energy for the main radiating life of the star. The hydrogen is steadily converted into helium.

When the protons are largely exhausted another

Primary Physics Theory

Ether separate out into hydrogen and oxygen but in the Primary State of matter—the Energy Form.

(*N.B.* — This carbon static potential is a mixture of two ingredients, viz. hydrogen and oxygen energy.)

*Modern Scientific Theory**Primary Physics Theory*

contraction takes place, and this time rapidly. The energy so liberated soon exceeds the thermal-nuclear energy. The centrifugal force increases and the star may break up.

This theory includes the approximate period in years which each of the above phases takes.

Note.—It is admitted that this theory of stellar evolution gives no explanation of the nature of original cosmic matter from which the star was formed, neither does it give any solution to the manner in which the heavy atomic nuclei were generated or evolved.

Reference.

Tolansky: *Introduction to Atomic Physics* (1945).

(3)

...

(3) The inequality in the homogeneous Ether is caused by a previous sun becoming an earth and momentarily concentrating its magnetic field on a point in space, during or at the time when the new earth is forming a crust.

Modern Scientific Theory

Primary Physics Theory

(4) ...

(4) The separation of the two components of the Ether is not mere separation but separation through polarisation. The hydrogen energy constituent conglobates on the point of inequality by exerting attraction upon itself, thus producing immense compression; this transforms latent energy, as energy, into energy as matter—the pre-atomic stage of matter.

In this condition little heat would be formed but light-matter would be generated through implosion (see text)—the compression being in the pre-atomic state.

(5) ...

(5) The other component, the oxygen energy, forms round the now conglobated hydrogen core and interaction between the two takes place, as is explained at length in the text.

(*N.B.* — Spectroscopic analysis shows that all stars have a high hydrogen content. This rather suggests a pre-atomic hydrogen in the energy-form giving rise to inter-

*Modern Scientific Theory**Primary Physics Theory*

action between the hydrogen core and surrounding complementary oxygen stressfield and ultimately the formation of the atomic state leading to nuclear interaction.)

The Author suggests, therefore, the following sequence for the evolution of a star and the generation of stellar energy:—

- (a) The only available source of matter must be in *the texture of space*—the Ether.
- (b) The texture of space must thus possess the essential ingredients for the formation of a star, but as latent static energy (or potential). So the first stage of matter is matter as latent energy or potential.
- (c) The Ether is latent carbon energy static, being a homogeneous blend of hydrogen and oxygen energy.
- (d) Polarisation (see text) causes conglobation of the hydrogen component of the Ether and a core of hydrogen-

Modern Scientific Theory

Primary Physics Theory

energy now forms—no longer latent but still in the pre-atomic state.

(e) This now active hydrogen mass forms, at least on the periphery, into nuclei—the proton stage.

(f) Hydrogen and oxygen energy, when the right conditions obtain, form electricity (see text). Peripheral interaction between the hydrogen core and its complementary oxygen stressfield brings about the formation of electrons, and electronic rings form round the hydrogen nuclei or protons. The atomic stage now begins, and with it the formation of the elements through nuclear interaction.